

2023 Model Aquatic Health Code

Code Language



U.S. Department of
Health and Human Services
Centers for Disease
Control and Prevention

4th Edition, February 2023

CS337253-A

2023 Model Aquatic Health Code, 4th Edition

CODE LANGUAGE

Posted on 02/01/2023

This information is distributed solely as guidance for the purpose of assisting local, state, territorial, and tribal public health agencies; aquatic facility inspection programs; the aquatics sector; building officials; and other parties to promote public health at public aquatic facilities. This document does not address all public health concerns associated with public aquatic facility use. It is the responsibility of the user of this document to establish appropriate public health practices and determine the applicability of regulatory limitations prior to each use.

Foreword

Swimming, relaxing, and playing in water have been global pastimes throughout written history. Twentieth-century advances in aquatics—combining disinfection, filtration, and recirculation systems—led to an explosion in the use of residential and public aquatic venues (e.g., pools, hot tubs, and water playgrounds). As residential and public pool use has swept across the United States, leisure time with family and friends in and around the pool has increased. Advances in public aquatic facility design have pushed the horizons of aquatic facilities from the traditional rectangular community pool to the multi-venue waterpark hosting tens of thousands of users per day. Indoor public aquatic facilities have transformed pools and waterparks into year-round attractions. At the same time, research has demonstrated the physical and psychosocial benefits of aquatics for all age groups.

However, these aquatics sector changes—combined with changes in the general population, emergence of pathogens protected from chlorine, and imperfect bather hygiene—have resulted in substantial increases in the number of reports of recreational water-associated outbreaks. This increase is driven by the substantial increase in the number of outbreaks associated with public aquatic venues and caused by *Cryptosporidium*. Drowning continues to claim the lives of far too many, particularly young children. Thousands of people visit U.S. emergency departments every year for pool chemical injuries. Public aquatic facility operation can be improved through engineering, education, and enforcement.¹ The increase in the number of reported outbreaks and the continued occurrence of drowning and other injuries suggest the prevention of public aquatic venue-associated illness, injury, disability, and death would benefit from building stronger environmental health regulatory programs and supporting them with strong partnerships. It also would be useful for public health officials to continue to play their strong role in overseeing design and construction, advising on operation and maintenance, and helping inform policy and management. Working in close collaboration with building code officials strengthens the overall coordination needed to prioritize public health at public aquatic facilities.

The 4th Edition of the Model Aquatic Health Code (MAHC) is the latest effort to improve the MAHC, which is a set of voluntary guidance based on science and best practices. The MAHC was developed to help programs that regulate public aquatic facilities reduce the risk of illness, injury, disability, and death in their communities (see MAHC history at <https://www.cdc.gov/mahc/editions/creation.html>). The MAHC is a leap forward from U.S. Centers for Disease Control and Prevention's (CDC) operational and technical manuals published in 1959, 1976, and 1981 and a logical progression of CDC's Healthy Swimming program, which was started in 2001. The 2023 MAHC (4th Edition) underscores CDC's long-term involvement and commitment to improving aquatic health and safety. MAHC guidance stemmed from concern about the substantially increasing number of reported outbreaks starting in the mid-1990s. Creation of the MAHC was the major recommendation of a 2005 national workshop, which was charged with developing recommendations to reduce the incidence of these outbreaks. Local, state, and federal public health officials and the aquatics sector formed an unprecedented 7-year collaboration to create the 2014 MAHC (1st Edition). The MAHC is being regularly updated with input from the Council for the Model Aquatic Health Code (CMAHC). The CMAHC was established to help CDC keep the MAHC up to date and current with the latest advances in the aquatics sector, while also responding to the latest public health reports of public aquatic venue-associated illness, injury, disability, and death. For each update cycle, CMAHC leads efforts to solicit, collect, and assess MAHC change requests (proposed changes to improve the MAHC); hosts a national stakeholder conference to discuss change requests; and holds a membership vote on the proposed changes. The partnership among public health, the aquatics sector, CMAHC, and academia strengthens the efforts to achieve CDC's vision of "healthy and safe aquatic experiences for everyone".

CDC

Atlanta, GA, 2023

¹ Centers for Disease Control and Prevention. Immediate closures and violations identified during routine inspections of public aquatic facilities - network for aquatic facility inspection surveillance, five states, 2013. Morbidity and mortality weekly report Surveillance summaries (Washington, DC : 2002). 2016 May 20;65(5):1-26.

Acknowledgments

The third Vote on the Code Conference was held by the Council for the Model Aquatic Health Code (CMAHC) October 21–23, 2020. CDC would like to acknowledge the hard work and dedication of CMAHC staff, CMAHC Technical Review Committee, CMAHC Technical Support Committees, CMAHC Board of Directors, and CMAHC membership for their dedication and time spent developing, assessing, discussing, and voting on Model Aquatic Health Code (MAHC) change requests (proposed changes to improve the MAHC). It is only through the dedicated efforts and contributions of experienced professionals that a scientifically sound, well-focused, and up-to-date MAHC is possible. CDC acknowledges with immense gratitude their substantial contribution to public health in the development of the 2023 MAHC (4th Edition). They deserve our heartfelt thanks and appreciation for volunteering their time and expertise to create the 2023 MAHC (4th Edition). In addition, CDC would like to also give its thanks to all the reviewers across the country who spent a great deal of time combing through the detail of the MAHC code and annex to submit change requests and who provided public comments. Their effort was worth the time invested; the MAHC has again been greatly improved.

CMAHC Staff

Dewey Case,
Technical Director (Dir)

Susan Wichmann,
Administrative Dir

Jill Mastrangelo,
Communications Dir

Kristie Riester, Executive Dir

CMAHC Board of Directors

Pieter Sheehan, *President*

Jim Rada, *Vice President*

Jason Ravenscroft, *Treasurer*

Carl Nylander, *Secretary*

Vincent Hill (*CDC Liaison*)

CDR Joe Laco (*CDC Liaison*)

Richard Carroll

Sung Choe

David Dyjack

Tom Fink

Franceen Gonzales

Olivia McCormick

Alvaro Mendoza

Ellen Meyer

Jun Naotsuka

Maurice Redmond

CMAHC Technical Review Committee

Amanda Tarrier, *Chair*

Ellen Meyer, *Vice Chair*

James Amburgey

Kevin Boyer

Michele Hlavsa

Jodi Jensen

CDR Joe Laco

Cindy Marshall

Tina Moore

Chris Nelson

Jason Schallock

Joe Stefanyak

Miklos Valdez

CMAHC Technical Support Committees

Michael Beatty

David Bell

Shawn DeRosa

Terrence Ewuell

Richard Falk

Ron George

Lee Hovis

Wayne Ivusich

Kyle McCawley

Brent Miller

Steve Miller

Steve Mueller

Steven Nicolich

Lori Thompson

Kent Wood

CDC Employees & Contractors

Michele Hlavsa, *Lead*

CDR Joe Laco, *Lead*

Samaria Aluko

Ashley Andújar

Maggie Byrne

Vincent Hill

Catherine Hough

Brian Hubbard

Heather Huntley

CDR Luis Rodriguez

Justin Rokisky Jr.

Pam Wigington

Table of Contents

Foreword.....	i	4.6.4 ^A Pool Water Heating	56
Acknowledgments	2	4.6.5 First Aid Area	56
Table of Contents	3	4.6.6 Emergency Exit	56
1.0 Glossary of Abbreviations	6	4.6.7 Drinking Fountains	56
2.0 Glossary of Terms	10	4.6.8 Garbage Receptacles	57
3.0 Cited Standards and Laws	21	4.6.9 Food and Drink Concessions	57
4.0^A Aquatic Facility Design Standards and Construction	27	4.6.10 Spectator Areas	57
4.1 Plan Submittal	27	4.6.11 Indoor Aquatic Facility Acoustics	57
4.1.1 Plan Submittal	27	4.7 Recirculation and Water Treatment	58
4.1.2 Content of Design Report	27	4.7.1 Recirculation Systems and Equipment	58
4.1.3 ^A Plan Approval	32	4.7.2 ^A Filtration	66
4.1.4 ^A Compliance Certificate	33	4.7.3 ^A Disinfection and pH Control	67
4.1.5 Construction Permits	33	4.7.4 ^A Water Replenishment System	77
4.2 Materials	34	4.7.5 Spas	77
4.2.1 Aquatic Venues	34	4.8 Decks and Equipment	78
4.2.2 Indoor Aquatic Facility	35	4.8.1 Decks	78
4.3 Equipment Standards	36	4.8.2 Diving Boards and Platforms	82
4.3.1 Accredited Standards	36	4.8.3 Starting Platforms	85
4.3.2 No Standards	36	4.8.4 Pool Slides [N/A]	86
4.3.3 Suitable for Intent	36	4.8.5 Lifeguard- & Safety-Related Equipment	86
4.4 Aquatic Facility and Venue Operation and Maintenance [N/A]	37	4.8.6 Barriers and Enclosures	86
4.5 Aquatic Venue Structure	37	4.8.7 ^A Aquatic Venue Cleaning Systems	89
4.5.1 ^A Design for Risk Management	37	4.9 Filter/Equipment Room	89
4.5.2 ^A Bottom Slope	37	4.9.1 Equipment Room	89
4.5.3 ^A Pool Access / Egress	37	4.9.2 ^A Chemical Storage Spaces	92
4.5.4 ^A Stairs	38	4.10 Hygiene Facilities	99
4.5.5 ^A Handrails	39	4.10.1 ^A General	99
4.5.6 Grab Rails	40	4.10.2 Location	99
4.5.7 Recessed Steps	41	4.10.3 ^A Design and Construction	99
4.5.8 Ladders	42	4.10.4 ^A Plumbing Fixture Requirements	100
4.5.9 Zero Depth (Sloped) Entries	43	4.10.5 ^A Provision of Suits, Towels, and Shared Equipment	102
4.5.10 Disabled Access	43	4.10.6 ^A Foot Baths	102
4.5.11 Color and Finish	43	4.10.7 ^A Sharps	102
4.5.12 Walls	44	4.11 Water Supply/ Wastewater Disposal	102
4.5.13 ^A Structural Stability	45	4.11.1 Water Supply	102
4.5.14 ^A Handholds	45	4.11.2 ^A Fill Spout	103
4.5.15 Infinity Edges	45	4.11.3 ^A Cross-Connection Control	103
4.5.16 ^A Underwater Benches	46	4.11.4 Deck Drains and Rinse Showers	103
4.5.17 Underwater Ledges	46	4.11.5 Sanitary Wastes	103
4.5.18 ^A Underwater Shelves	47	4.11.6 ^A Pool Wastewater	103
4.5.19 Depth Markers and Markings	47	4.12 Specific Aquatic Venues	104
4.5.20 Aquatic Venue Shell Maintenance [N/A]	49	4.12.1 Spas	104
4.5.21 ^A Special Use Aquatic Venues	49	4.12.2 Waterslides and Landing Pools	105
4.6 Indoor / Outdoor Environment	50	4.12.3 ^A Wave Pools	107
4.6.1 Lighting	50	4.12.4 Therapy Pools	108
4.6.2 ^A Indoor Aquatic Facility Ventilation	51	4.12.5 Lazy Rivers	108
4.6.3 ^A Indoor/Outdoor Aquatic Facility Electrical Systems and Components	55	4.12.6 Moveable Floors	109
		4.12.7 Bulkheads	110
		4.12.8 ^A Interactive Water Play Venues	110
		4.12.9 Wading Pools	112
		4.12.10 ^A Other Aquatic Features	112

5.0 Aquatic Facility Operation and Maintenance	113	5.9.2	Chemical Handling	141	
5.1	Operating Permits	113	5.10	Hygiene Facilities	142
5.1.1	Owner Responsibilities	113	5.10.1	General [N/A]	142
5.1.2	Operating Permits	113	5.10.2	Location [N/A]	142
5.2	Inspections	113	5.10.3	Bathhouse Design [N/A]	142
5.2.1	Preoperational Inspections	113	5.10.4	Plumbing Fixture Requirements	142
5.2.2	Exemptions	114	5.10.5	Provision of Suits, Towels, and Shared Equipment	144
5.2.3 ^A	Variances	114	5.11	Water Supply / Wastewater Disposal [N/A]	144
5.3	Equipment Standards [N/A]	114	5.12	Special Requirements for Specific Aquatic Venues	144
5.4	Aquatic Facility and Venue Operation and Maintenance	114	5.12.1	Spas	144
5.4.1	Closure and Reopening	114	5.12.2 ^A	Waterslides and Landing Pools	144
5.4.2 ^A	Preventive Maintenance Plan	115	5.12.3	Wave Pools	144
5.4.3	General Operations [N/A]	116	5.12.4	Therapy Pools [N/A]	145
5.5	Aquatic Venue Structure	116	5.12.5	Lazy Rivers [N/A]	145
5.5.1	Shape [N/A]	116	5.12.6	Moveable Floors	145
5.5.2	Access Ladders	116	5.12.7	Bulkheads	145
5.5.3	Color and Finish [N/A]	116	5.12.8	Interactive Water Play Aquatic Venues	145
5.5.4	Walls [N/A]	116	5.12.9	Wading Pools [N/A]	145
5.5.5 ^A	Depth Markings	116	5.12.10	Other Aquatic Venues [N/A]	145
5.5.6 ^A	Pool Shell Maintenance	116	6.0 Policies and Management	146	
5.6	Indoor / Outdoor Environment	116	6.0.1 ^A	Staff Training	146
5.6.1	Lighting	116	6.1	Qualified Operator Training	147
5.6.2 ^A	Indoor Aquatic Facility Ventilation	117	6.1.1 ^A	Qualified Operator Qualifications and Certification	147
5.6.3	Indoor / Outdoor Aquatic Facility Electrical Systems and Components	118	6.1.2 ^A	Essential Topics in Qualified Operator Training Courses	147
5.6.4	Facility Heating	120	6.1.3	General Requirements for Operator Training Courses	159
5.6.5	First Aid Room [N/A]	121	6.2 ^A	Lifeguard Training	161
5.6.6	Emergency Exit	121	6.2.1 ^A	Lifeguard Qualifications	161
5.6.7	Plumbing	121	6.2.2	Lifeguard Supervisor Training	165
5.6.8	Solid Waste Management	122	6.3	Facility Staffing	167
5.6.9	Decks	122	6.3.1	Qualified Operator Requirements and Availability	167
5.6.10	Aquatic Facility Maintenance	123	6.3.2	Aquatic Facilities Requiring Qualified Lifeguards	168
5.7	Recirculation and Water Treatment	124	6.3.3 ^A	Safety Plan	168
5.7.1	Recirculation Systems and Equipment	124	6.3.4	Staff Management	172
5.7.2	Filtration	125	6.4 ^A	Aquatic Facility Management	175
5.7.3 ^A	Water Treatment Chemicals and Systems	128	6.4.1	Operations	175
5.7.4	Water Sample Collection and Testing	135	6.4.2	Patron-Related Management Aspects	179
5.7.5 ^A	Water Quality Chemical Testing Frequency	136	6.5 ^A	Fecal/Vomit/Blood Contamination Response	181
5.7.6 ^A	Water Clarity	137	6.5.1 ^A	Contamination Response Plan	181
5.8	Decks and Equipment	137	6.5.2	Aquatic Venue Water Contamination Response	181
5.8.1 ^A	Deck Areas	137	6.5.3	Aquatic Venue Water Contamination Disinfection	182
5.8.2	Diving Boards and Platforms [N/A]	137	6.5.4	Surface Contamination Cleaning and Disinfection	184
5.8.3 ^A	Starting Platforms	137			
5.8.4	Pool Slides [N/A]	137			
5.8.5	Lifeguard- and Safety-Related Equipment	137			
5.8.6	Barriers and Enclosures	140			
5.9 ^A	Filter/Equipment Room	140			
5.9.1	Chemical Storage	140			

6.6	AHJ Inspections	184
6.6.1 ^A	Inspection Process	184
6.6.2	Publication of Inspection Forms	185
6.6.3	Imminent Health Hazards	185
6.6.4	Enforcement	186
6.6.5 ^A	Enforcement Penalties	186
7.0	Special Venues	188
7.1 ^A	Floatation Tank Design and Construction	188
7.1.1	Design and Construction	188
7.1.2	Materials	192
7.1.3	Equipment Standards	192
7.1.4 ^A	Floatation Tank Electrical Systems and Components	192
7.1.5	Food and Drink Concessions	193
7.1.6	Water Supply/Wastewater Disposal	193
7.1.7	Circulation System	193
7.1.8 ^A	Disinfection	193
7.1.9 ^A	Ventilation	194
7.1.10	Floors	194
7.1.11	Cleansing Showers	194
7.2	Floatation Tank Operation	194
7.2.1	Operating Permits	194
7.2.2	Inspections	195
7.2.3	Operation and Maintenance	196
7.2.4	Ventilation	196
7.2.5	Electrical Systems and Components	196
7.2.6	Plumbing	198
7.2.7	Solid Waste Management	199
7.2.8 ^A	Treatment System Required Operation Time	199
7.2.9	Disinfection	199
7.2.10	USP Grade Magnesium Sulfate	200
7.2.11	Cleansing Showers and Hygiene Facilities	200
7.2.12 ^A	Cleaning	200
7.2.13 ^A	Fecal/Vomit/Blood Contamination Response	200
7.2.14	Operations	201
7.2.15	AHJ Inspections	203

1.0 Glossary of Abbreviations

AAU	Amateur Athletic Union
ACA	American Coatings Association
ACCA	Air Conditioning Contractors of America
ACI	American Concrete Institute
ADA	Americans with Disabilities Act
ADAAG	Americans with Disabilities Act Accessibility Guidance
AED	Automated External Defibrillator
AHA	American Heart Association
AHJ	Authority Having Jurisdiction
AMCA	Air Movement and Control Association
ANSI	American National Standards Institute
APSP	Association of Pool and Spa Professionals
ARC	American Red Cross
ASHI	American Safety & Health Institute
ASHRAE	American Society of Heating, Refrigerating and Air-Conditioning Engineers
ASME	American Society of Mechanical Engineers
ASTM	ASTM International (formerly American Society for Testing and Materials)
ATSDR	United States Agency for Toxic Substances and Disease Registry
BCDMH	1-bromo-3-chloro-5, 5-dimethylhydantoin
BVM	Bag-Valve Mask
CCPRF	Citizen CPR Foundation
CDC	United States Centers for Disease Control and Prevention
CEL	Certified Equipment List
CERCLA	Comprehensive Environmental Response, Compensation, and Liability Act
CEU	Continuing Education Units
CFM	Cubic Feet Per Minute
CFOC	Caring for Our Children
CFP	Conference for Food Protection
CFR	Code of Federal Regulations
CI	Chlorine Institute
CMAHC	The Council for the Model Aquatic Health Code
CoSTR	Consensus on Science and Treatment Recommendations
CPR	Cardiopulmonary Resuscitation
CPSC	United States Consumer Product Safety Commission
CSA	Canadian Standards Association
CYA	Cyanuric Acid

DBDMH	Dibromodimethylhydantoin
DBP	Disinfection By-Product
DCOF	Dynamic Coefficient of Friction
DIN	Deutsches Institut für Normung (German Institute for Standardization)
DVGW	Deutscher Verein des Gas- und Wasserfaches e.V. – Technisch wissenschaftlicher Verein (German Technical and Scientific Association for Gas and Water)
EAP	Emergency Action Plan
ECC	Emergency Cardiovascular Care
ECCU	Emergency Cardiovascular Care Update
EPA	United States Environmental Protection Agency
EPCRA	Emergency Planning and Community Right-to-Know Act
ES	European Standard
FAC	Free Available Chlorine
FDA	United States Food and Drug Administration
FIFRA	Federal Insecticide, Fungicide, and Rodenticide Act
FINA	Fédération Internationale de Natation Amateur
FPM	Feet Per Minute
GFCI	Ground-Fault Circuit Interrupter
GPM	Gallons Per Minute
HazCom	Hazard Communication Standard
HMIS	Hazardous Material Identification System
HOBr	Hypobromous Acid
HOCl	Hypochlorous Acid
HSC	California Health and Safety Code
HSEESS	Hazardous Substance Emergency Events Surveillance System
HVAC	Heating, Ventilation, and Air Conditioning
IAEI	International Association of Electrical Inspectors
IAF	International Aquatic Foundation
IAPMO	International Association of Plumbing and Mechanical Officials
IARC	International Agency for Research on Cancer
IBC	International Building Code
ICBO	International Council of Building Officials
ICC	International Code Council
IEEE	Institute of Electrical and Electronics Engineers
IESNA	Illuminating Engineering Society of North America
IFC	International Fire Code
ILCOR	International Liaison Committee on Resuscitation
IMC	International Mechanical Code

IPC	International Plumbing Code
ISEA	International Safety Equipment Association
ISO	International Organization for Standardization
ISPSC	International Swimming Pool and Spa Code
MAHC	Model Aquatic Health Code
MERV	Minimum Efficiency Reporting Value
METS	Metabolic Equivalents
MRC	Moisture Removal Capacity
MRE	Moisture Removal Efficiency
MSBL	Maximum Sustainable Bather Load
NCAA	National Collegiate Athletic Association
NEC	National Electrical Code
NEHA	National Environmental Health Association
NEISS	National Electrical Injury Surveillance System
NEMA	National Electrical Manufacturers Association
NFHS	National Federation of State High School Associations
NFPA	National Fire Protection Association
NIOSH	National Institute for Occupational Safety and Health
NOAA	National Oceanic and Atmospheric Administration
NPDS	National Poison Data System
NPSH	Net Positive Suction Head
NRPA	National Recreation and Park Association
NRR	Noise Reduction Ratings
NRTL	Nationally Recognized Testing Laboratory
NSF	NSF International (formerly National Sanitation Foundation)
NSPF	National Swimming Pool Foundation
OEM	Original Equipment Manufacturer
ÖNORM	Österreichisches Normungsinstitut (Austrian Standards Institute)
ORP	Oxidation Reduction Potential
OSHA	Occupational Safety and Health Administration
PEL	Permissible Exposure Limit
PERC	Propane Education and Research Council
PHMB	Polyhexamethylene Biguanide Hydrochloride
PMRA	Health Canada Pest Management Regulatory Agency
PPE	Personal Protective Equipment
PPM	Parts Per Million
PVC	Polyvinyl Chloride

PVC-P	Plasticized Polyvinyl Chloride
PWTAG	Pool Water Treatment Advisory Group
RED	Reduction Equivalent Dose
RLV	Relative Limit Value
RP	Reduced Pressure Principle Assembly
RPZ	Reduced Pressure Zone
RWI	Recreational Water–Associated Illness
SCBA	Self-Contained Breathing Apparatus
SCI	Spinal Cord Injury
SDS	Safety Data Sheet
SMACNA	Sheet Metal and Air Conditioning Contractors’ National Association
SOFAs	Submerged Suction Outlets Fitting Assemblies
STC	Sound Transmission Class
SVRS	Safety Vacuum Release System
TB	Total Bromine
TDH	Total Dynamic Head
TDS	Total Dissolved Solids
THM	Trihalomethane
TLV	Threshold Limit Value
UL	Underwriters Laboratories
UMC	Uniform Mechanical Code
UPC	Uniform Plumbing Code
USACE	United States Army Corps of Engineers
USC	United States Code
USDOE	United States Department of Energy
USLSC	United States Lifeguarding Standards Coalition
USPSHTC	Uniform Swimming Pool, Spa, and Hot Tub Code
UV	Ultraviolet
UVT	Ultraviolet Transmittance
VFD	Variable Frequency Drive
VGB Act	Virginia Graeme Baker Pool and Spa Safety Act
WC	Water Closet
WHO	World Health Organization
WQTD	Water Quality Testing Device
YMCA	Young Men’s Christian Association

2.0 Glossary of Terms

“**Accessible Route**” means access/egress standards as defined by 2010 ADA Standards for Accessible Design.

“**Activity Pool**” See “*Pool.*”

“**Air Delivery Rate**” means the supply cfm of the air handler system(s) comprised of a combination of outside air and return air minus any exhaust air if exhausted within the air handler itself.

“**Air Handling System**” means equipment that brings in outdoor air into a building and removes air from a building for the purpose of introducing air with fewer contaminants and removing air with contaminants created while bathers are using aquatic venues. The system contains components that move and condition the air for temperature, humidity, and pressure control, and transport and distribute the air to prevent condensation, corrosion, and stratification, provide acceptable indoor air quality, and deliver outside air to the breathing zone.

“**Agitated Water**” See “*Theoretical Peak Occupancy.*”

“**Alpha Bar**” See “*Average Sound Absorption Coefficient.*”

“**Aquatic Facility**” means a physical place that contains one or more aquatic venues and support infrastructure.

“**Aquatic Facility or Aquatic Venue Enclosure**” means an enclosure, as defined herein, that surrounds and secures an aquatic facility or aquatic venue.

“**Aquatic Feature**” means an individual component within an aquatic venue. Examples include slides, structures designed to be climbed or walked across, and structures that create falling or shooting water.

“**Aquatic Venue**” means an artificially constructed structure or modified natural structure where the general public is exposed to water intended for recreational or therapeutic purpose and where the primary intended use is not watering livestock, irrigation, water storage, fishing, or habitat for aquatic life. Such structures do not necessarily contain standing water, so water exposure may occur via contact, ingestion, or aerosolization. Examples include swimming pools, wave pools, lazy rivers, surf pools, spas (*including spa pools and hot tubs*), therapy pools, waterslide landing pools, spray pads, and other interactive water venues.

- “**Increased Risk Aquatic Venue**” means an aquatic venue which due to its intrinsic characteristics and intended users has a greater likelihood of affecting the health of the bathers of that venue by being at increased risk for microbial contamination (*e.g., by children ages less than 5 years*) or being used by people that may be more susceptible to infection (*e.g., therapy patients with open wounds*). Examples of increased-risk aquatic venues include spray pads, wading pools and other aquatic venues designed for children ages less than 5 years as well as therapy pools.
- “**Lazy River**” means a channeled flow of water of near-constant depth in which the water is moved by pumps or other means of propulsion to provide a river-like flow that transports bathers over a defined path. A lazy river may include play features and devices. A lazy river may also be referred to as a tubing pool, leisure river, leisure pool or a current channel.
- “**Spa**” means a structure intended for either warm or cold water where prolonged exposure is not intended. Spa structures are intended to be used for bathing or other recreational uses and are not usually drained and refilled after each use. It may include, but is not limited to, hydrotherapy, air induction bubbles, and recirculation.
- “**Special Use Aquatic Venue**” means aquatic venues that do not meet the intended use and design features of any other aquatic venue or pool listed/identified in this Code.

“**Authority Having Jurisdiction**” (*AHJ*) means an agency, organization, office, or individual responsible for enforcing the requirements of a code or standard, or for approving equipment, materials, installations, or procedures.

“**Automated Controller**” means a system of at least one chemical probe, a controller, and auxiliary or integrated component that senses the level of one or more water parameters and provides a signal to other equipment to maintain the parameters within a user-established range.

“Available Chlorine” See “Chlorine.”

“Average Sound Absorption Coefficient” (*Alpha Bar*) means the weighted average sound absorption coefficient for a room calculated by weighting the sound absorption coefficients of the individual surfaces in the room according to their respective areas and taking the arithmetic average as follows (*especially in the 500 Hz and 1,000 Hz frequencies*): $\text{And } m^2 \text{ (or } ft^2\text{)}$; where areas of the individual sound absorptive surfaces, $m^2 \text{ (or } ft^2\text{)}$ respective individual absorption coefficients (dimensionless). A sound absorption coefficient is of a surface, in a specified frequency band, the fraction of the randomly incident sound power which is absorbed (*or otherwise not reflected*) by a material metric: sabin/ m^2 .

“Backflow” means a hydraulic condition caused by a difference in water pressure that causes an undesirable reversal of the flow as the result of a higher pressure in the system than in its supply.

“Background Noise” means noise from all sources unrelated to a particular sound that is the object of interest. Background noise may include airborne, structure borne and instrument noise.

“Barrier” means an obstacle intended to deter direct access from one point to another.

“Bather” means a person at an aquatic venue who has contact with water either through spray or partial or total immersion. The term bather as defined, also includes staff members, and refers to those users who can be exposed to contaminated water as well as potentially contaminate the water.

“Bather Count” means the number of bathers in an aquatic venue at any given time.

“Best Practice” means a technique or methodology that, through experience and research, has been proven to reliably lead to a desired result.

“Body of Water” (*per NEC, q.v.*) means any aquatic venue holding standing water, whether permanent or storable.

“Breakpoint Chlorination” means the conversion of inorganic chloramine compounds to nitrogen gas by reaction with Free Available Chlorine. When chlorine is added to water containing ammonia (*from urine, sweat, or the environment, for example*), it initially reacts with the ammonia to form monochloramine. If more chlorine is added, monochloramine is converted into dichloramine, which decomposes into nitrogen gas, hydrochloric acid, and chlorine. The apparent residual chlorine decreases since it is partially reduced to hydrochloric acid. The point at which the drop occurs is referred to as the “breakpoint”. The amount of free chlorine that must be added to the water to achieve breakpoint chlorination is approximately 10 times the amount of combined chlorine in the water. As additional chlorine is added, all inorganic combined chlorine compounds disappear, resulting in a decrease in eye irritation potential and “chlorine odors.”

“Bulkhead” means a movable partition that physically separates a pool into multiple sections.

“Certified, Listed, and Labeled” means equipment, materials, products, or services included in a list published by an ANSI—accredited certification organization where said equipment, material, product, or service is evaluated against specific criteria and whose listing either states that it meets identified standards or has been tested and found suitable for a specified purpose. In sections of this code where equipment, materials, products, or services are referred to with terms such as “approved”, “verified”, or similar terms to a referenced standard, these terms also mean “certified, listed, and labeled.”

“Chemical Storage Space” means a space in an aquatic facility used for the storage of pool chemicals such as acids, salt, or corrosive or oxidizing chemicals.

“Chlorine” means an element that at room temperature and pressure is a heavy greenish yellow gas with a characteristic penetrating and irritating smell; it is extremely toxic. It can be compressed in liquid form and stored in heavy steel tanks. When mixed with water, chlorine gas forms hypochlorous acid (*HOCl*), the primary chlorine-based disinfecting agent, hypochlorite ion, and hydrochloric acid. HOCl dissociation to hypochlorite ion is highly pH dependent. Chlorine is a general term used in the MAHC which refers to HOCl and hypochlorite ion in aqueous solution derived from chlorine gas or a variety of chlorine-based disinfecting agents.

- **“Available Chlorine”** means the amount of chlorine in the +1 oxidation state, which is the reactive, oxidized form. In contrast, chloride ion (*Cl⁻*) is in the -1 oxidation state, which is the inert, reduced state.

Available Chlorine is subdivided into Free Available Chlorine and Combined Available Chlorine. Pool chemicals containing Available Chlorine are both oxidizers and disinfectants. Elemental chlorine (Cl_2) is defined as containing 100% available chlorine. The concentration of Available Chlorine in water is normally reported as ppm (mg/L) “as Cl_2 ”, that is, the concentration is measured on a Cl_2 basis, regardless of the source of the Available Chlorine.

- **“Combined Available Chlorine” or “Combined Chlorine” or “CAC” or “CC”** means the concentration of available chlorine present in the form of inorganic or organic chloramines. Combined available chlorine is less reactive than free available chlorine and organic chloramines are generally less reactive oxidizers than the inorganic chloramines. Combined chlorine is determined by taking the difference between the Total Chlorine (TC) and DPD-FC concentrations. $CC = TC - DPD-FC$.
- **“Cyanurate-bound available chlorine” or “CBC”** means the concentration of available chlorine that is bound to cyanurate.
- **“DPD Free Chlorine” or “DPD-FC”** means the FC (“free chlorine”) concentration from DPD-based test methods. The DPD-based test result for FC includes cyanurate-bound available chlorine as well as $HOCl$ and OCl^- , that is, $DPD-FC = FAC + CBC$. The terms DPD-FC and FAC would be interchangeable only in the absence of cyanuric acid.
- **“Free Available Chlorine” or “FAC” or “Free Chlorine Residual”** means the portion of the total available chlorine that is not “combined chlorine” or “cyanurate-bound available chlorine” and is primarily present as hypochlorous acid ($HOCl$) or hypochlorite ion (OCl^-). Molecular chlorine (Cl_2), trichloride (Cl_3^-), and chlorine monoxide (Cl_2O) are also present at very low concentrations, depending on chlorine ion concentration, and these compounds are also counted as free available chlorine. The pH of the water determines the relative amounts of $HOCl$ and OCl^- . $HOCl$ is a very effective biocide and is the active biocide in pool water. OCl^- is also a biocide but acts more slowly than $HOCl$. Thus, chlorine is a more effective biocide at low pH than at high pH. A free chlorine residual must be maintained for adequate disinfection.
- **“Total Available Chlorine”** means the “TC” concentration from DPD-based test methods with iodide reagent added. All forms of available chlorine which react with iodide are measured as Total Available Chlorine (TC).

“Circulation Path” means an exterior or interior way of passage from one part of an aquatic facility to another for pedestrians, including, but not limited to walkways, pathways, decks, and stairways.

“Cleansing Shower” See “Shower.”

“Climate Control System” means a combination of the pieces of equipment designed to control the temperature, humidity, introduce ventilation air and maintain building negative pressure.

“Code” means a systematic statement of a body of law, especially one given statutory force.

“Combustion Device” means any appliance or equipment using fire. These include, but may not be limited to, gas or oil furnaces, boilers, pool heaters, domestic water heaters, etc.

“Construction Joint” means a watertight joint provided to facilitate stopping places in the construction process. Construction joints also serve as contraction joints which control cracking.

“Contaminant” means a substance that soils, stains, corrupts, or infects another substance by contact or association.

“Contamination Response Plan” means a plan for handling contamination from formed-stool, diarrheal-stool, vomit, and blood.

“Corrosive Material” means pool chemicals, fertilizers, cleaning chemicals, oxidizing cleaning materials, salt, de-icing chemicals, other corrosive or oxidizing materials, pesticides, and such other materials which may cause injury to people or damage to the building, air-handling equipment, electrical equipment, safety equipment, or fire-suppression equipment, whether by direct contact or by contact via fumes or vapors, whether in original form

or in a foreseeably likely decomposition, pyrolysis, or polymerization form. Refer to labels and SDSs.

“**Crack**” means any and all breaks in the structural shell of a pool vessel or deck.

“**Cross-Connection**” means a connection or arrangement, physical or otherwise, between a potable water supply system and a plumbing fixture, tank, receptor, equipment, or device, through which it may be possible for non-potable, used, unclean, polluted, and contaminated water, or other substances to enter into a part of such potable water system under any condition.

“**CT Inactivation Value**” means a representation of the concentration of the disinfectant (C) multiplied by time in minutes (T) needed for inactivation of a particular contaminant. The concentration and time are inversely proportional; therefore, the higher the concentration of the disinfectant, the shorter the contact time required for inactivation. The CT inactivation value can vary with pH or temperature change so these values must also be supplied to allow comparison between values.

“**Deck**” means surface areas serving the aquatic venue, including the dry deck, perimeter deck, and pool deck.

- “**Dry Deck**” means all pedestrian surface areas within the aquatic venue enclosure not subject to frequent splashing or constant wet foot traffic. The dry deck is not perimeter deck or pool deck, which connects the pool to adjacent amenities, entrances, and exits. Landscape areas are not included in this definition.
- “**Perimeter Deck**” means the hardscape surface area immediately adjacent to and within 4 feet (1.2 m) of the edge of the swimming pool also known as the “wet deck” area.
- “**Pool Deck**” means surface areas serving the aquatic venue, beyond perimeter deck, which is expected to be regularly trafficked and made wet by bathers.
- “**Wet Deck**” means the sum of the perimeter deck and pool deck.

“**Design Professional**” means a person who is registered or licensed to practice their respective design profession as defined by the local, state, territorial, federal, and tribal laws governing professional practice within the jurisdiction where the project is to be constructed.

“**Diaper-Changing Station**” means a hygiene station that includes a diaper-changing unit, handwashing sink, soap and dispenser, a means for drying hands, trash receptacle, and disinfectant products to clean after use.

“**Diaper-Changing Unit**” means a diaper-changing surface that is part of a diaper-changing station.

“**Dichloramine**” means a disinfection byproduct formed when chlorine binds to nitrogenous waste in pool water to form an amine-containing compound with two chlorine atoms ($NHCl_2$). It is a known acute respiratory and ocular irritant.

“**Disinfection**” means a treatment that kills or irreversibly inactivates microorganisms (*e.g., bacteria, viruses, and parasites*); in water treatment, a chemical (*commonly chlorine, chloramine, or ozone*) or physical process (*e.g., ultraviolet radiation*) can be used.

“**Disinfection Byproduct**” (DBP) means a chemical compound formed by the reaction of a disinfectant (*e.g., chlorine*) with a precursor (*e.g., natural organic matter, nitrogenous waste from bathers*) in a water system (*pool, water supply*).

“**Diving Pool**” *See “Pool.”*

“**Drop Slide**” *See “Slide.”*

“**Dry Deck**” *See “Deck.”*

“**Emergency Action Plan**” (EAP) means a plan that identifies the objectives that need to be met for a specific type of emergency, who will respond, what each person’s role will be during the response and what equipment is required as part of the response.

“**Enclosure**” means an uninterrupted constructed feature or obstacle used to surround and secure an area that is intended to effectively prevent unpermitted, uncontrolled, and unfettered access. It is designed to resist climbing and to prevent passage through it and under it. Enclosure can apply to aquatic facilities or aquatic venues.

“EPA Registered” means all products regulated and registered under the Federal Insecticide, Fungicide, and Rodenticide Act (*FIFRA*) by the EPA.

“Equipment Room or Area” means a space intended for the operation of pool pumps, filters, heaters, and controllers. This space is not intended for the storage of hazardous pool chemicals.

“Exit Gate” means an emergency exit, which is a gate or door allowing free exit at all times.

“Expansion Joint” means a watertight joint provided in a pool vessel used to relieve flexural stresses due to movement caused by thermal expansion/contraction.

“Fixture” See *“Plumbing Fixture”* or *“Hygiene Fixture.”*

“Flat Water” See *“Theoretical Peak Occupancy.”*

“Floatation Tank” (*a.k.a. Float Tank, Float Room/Pod/Spa/Chamber, Isolation Tank, or Sensory Deprivation Tank*) means a tub that contains a saturated solution of magnesium sulfate having a specific gravity of 1.23 to 1.3, provides a light and sound reduced environment, and is maintained at a temperature of approximately 92–96°F / 33.3–35.6°C.

“Floatation Tank Solution” means a saturated solution of magnesium sulfate having a specific gravity of 1.23 to 1.3.

“Flume” means the riding channels of a waterslide which accommodate riders using or not using mats, tubes, rafts, and other transport vehicles as they slide along a path lubricated by a water flow.

“Foot Bath” means standing water in which bathers or aquatics staff rinse their feet.

“Free Chlorine Residual” or **“Free Available Chlorine”** See *“Chlorine.”*

“Ground-Fault Circuit Interrupter” (*GFCI*) means a device for protection of personnel that de-energizes an electrical circuit or portion thereof in the event of excessive ground current.

“Handwashing Station” means a location which has a handwashing sink, adjacent soap with dispenser, hand drying device or paper towels and dispenser, and trash receptacle.

“Hot Water” See *“Theoretical Peak Occupancy.”*

“Hygiene Facility” means a structure or part of a structure that contains toilet, shower, diaper-changing unit, handwashing station, and dressing capabilities serving bathers and patrons at an aquatic facility.

“Hygiene Fixtures” means all components necessary for hygiene facilities including plumbing fixtures, diaper-changing stations, handwashing stations, trashcans, soap dispensers, paper towel dispensers or hand dryers, and toilet paper dispensers.

“Hyperchlorination” means the intentional and specific raising of chlorine levels for a prolonged period of time to inactivate pathogens following a fecal or vomit release in an aquatic venue.

“Imminent Health Hazard” means a substantial threat or danger to health that is considered to exist when there is evidence sufficient to show that a product, practice, circumstance, or event creates a situation that requires immediate correction or cessation of operation to prevent injury based on the number of potential injuries and the nature, severity, and duration of the anticipated injury or illness.

“Increased Risk Aquatic Venue” See *“Aquatic Venue.”*

“Indoor Aquatic Facility” means a physical place that contains one or more aquatic venues and the surrounding bather and spectator/stadium seating areas within a structure that meets the definition of “Building” per the International Building Code (*IBC*). Indoor Aquatic Facility does not include equipment, chemical storage, or bather hygiene rooms or any other rooms with a direct opening to the aquatic facility. Otherwise known as a natatorium.

“Infinity Edge” means a pool wall structure and adjacent perimeter deck that is designed in such a way where the top of the pool wall and adjacent deck are not visible from certain vantage points in the pool or from the opposite

side of the pool. Water from the pool flows over the edge and is captured and treated for reuse through the normal pool filtration system. They are often also referred to as “vanishing edges,” “negative edges,” or “zero edges.”

“**Inlet**” means wall or floor fittings where treated water is returned to the pool.

“**Interactive Water Play Aquatic Venue**” means any indoor or outdoor installation that includes sprayed, jetted, or other water sources contacting bathers and not incorporating standing or captured water as part of the bather activity area. These aquatic venues are also known as splash pads, spray pads, and wet decks. For the purposes of the MAHC, only those designed to recirculate water and intended for public use and recreation shall be regulated.

“**Interior Space**” means any substantially enclosed space having a roof and having a wall or walls which might reduce the free flow of outdoor air. Ventilation openings, fans, blowers, windows, doors, etc., shall not be construed as allowing free flow of outdoor air.

“**Island**” means a structure inside a pool where the perimeter is completely surrounded by the pool water and the top is above the surface of the pool.

“**Landing Pool**” See “*Pool.*”

“**Lazy River**” See “*Aquatic Venue.*”

“**Lifeguard Supervisor**” means an individual responsible for the oversight of lifeguard performance and emergency response at an aquatic facility, who has successfully completed a lifeguard supervisor training course that meets the requirements of this code, and who holds a valid certificate for such training.

“**mg/L**” means milligrams per liter and is the equivalent metric measure to parts per million (*ppm*).

“**Moisture Removal Capacity**” means the amount of condensate produced by the climate control equipment which includes the effects of reheat coils, circulating fans and other components in the air stream; excluding supplementary heating, cooling, or outdoor air; and expressed in pounds of moisture/hour.

“**Moisture Removal Efficiency**” (*MRE*) means a ratio of the MRC in pounds of moisture/hour to the power input values in kilowatts at any given set of Rating Conditions expressed in pounds of moisture/kilowatt hour.

“**Monitoring**” means the regular and purposeful observation and checking of systems or facilities and recording of data, including system alerts, excursions from acceptable ranges, and other facility issues. Monitoring includes human or electronic means.

“**Moveable Floors**” means a pool floor whose depth varies through the use of controls.

“**No Diving Marker**” means a sign with the words “No Diving” and the universal international symbol for “No Diving” pictured as an image of a diver with a red circle with a slash through it.

“**Noise Criterion**” means the single number rating that is somewhat sensitive to the relative loudness and speech interference properties of a given noise spectrum. The method consists of a family of criterion curves extending from 63 to 8,000 Hz and a tangency rating procedure. The criterion curves define the limits of octave band spectra that must not be exceeded to meet occupant acceptance in certain spaces.

“**Non-Substantial Alteration**” means the alteration, modification, or renovation of an aquatic facility or an aquatic venue where the total cost of the work is 50% or less of the replacement cost of the aquatic facility or the aquatic venue.

“**Oocyst**” means the thick-walled, environmentally resistant structure released in the feces of infected animals that serves to transfer the infectious stages of sporozoan parasites (*e.g., Cryptosporidium*) to new hosts.

“**Oxidation**” means the process of changing the chemical structure of water contaminants by either increasing the number of oxygen atoms or reducing the number of electrons of the contaminant or other chemical reaction, which allows the contaminant to be more readily removed from the water or made more soluble in the water.

“**Oxidation Reduction Potential**” (*ORP*) means a measure of the tendency for a solution to either gain or lose electrons; higher (*more positive*) oxidation reduction potential indicates a more oxidative solution.

“**Patron**” means a bather or other person or occupant at an aquatic facility who may or may not have contact with

aquatic venue water either through partial or total immersion. Patrons may not have contact with aquatic venue water but could still be exposed to potential contamination from the aquatic facility air, surfaces, or aerosols.

“Peninsula / Wing Wall” means a structural projection into a pool intended to provide separation within the body of water.

“Perimeter Deck” See *“Deck.”*

“Perimeter Gutter System” means a weir or trough around the perimeter of a swimming pool that is used to skim the surface of the water and return the water to the treatment system.

“pH” means the negative log of the concentration of hydrogen ions. When water ionizes, it produces hydrogen ions (H^+) and hydroxide ions (OH^-). If there is an excess of hydrogen ions the water is acidic. If there is an excess of hydroxide ions the water is basic. pH ranges from 0 to 14. Pure water has a pH of 7.0. If pH is higher than 7.0, the water is said to be basic, or alkaline. If the water’s pH is lower than 7.0, the water is acidic. As pH is raised, more hypochlorous acid ($HOCl$) ionization occurs and chlorine disinfectants decrease in effectiveness.

“Plumbing Fixture” means a receptacle, fixture, or device that is connected to a water supply system or discharges to a drainage system or both and may be used for the distribution and use of water; for example: toilets, urinals, showers, and hose bibs.

“Pool” means a subset of aquatic venues designed to have standing water for total or partial bather immersion. This does not include spas.

- **“Activity Pool”** means a water attraction designed primarily for play activity that uses constructed features and devices including pad walks, flotation devices, and similar attractions.
- **“Diving Pool”** means a pool used exclusively for diving.
- **“Landing Pool”** means an aquatic venue or designated section of an aquatic venue located at the exit of one or more waterslide flumes. The body of water is intended and designed to receive a bather emerging from the flume for the purpose of terminating the slide action and providing a means of exit to a deck or walkway area.
- **“Skimmer Pool”** means a pool using a skimmer system.
- **“Surf Pool”** means any pool designed to generate waves dedicated to the activity of surfing on a surfboard or analogous surfing device commonly used in the ocean and intended for sport as opposed to general play intent for wave pools.
- **“Therapy Pool”** means a pool used exclusively for aquatic therapy, physical therapy, or rehabilitation to treat a diagnosed injury, illness, or medical condition, wherein the therapy is provided under the direct supervision of a licensed physical therapist, occupational therapist, or athletic trainer. This could include wound patients or immunocompromised patients whose health could be impacted if there is not additional water quality protection.
- **“Wading Pool”** means any pool used exclusively for wading and intended for use by young children where the depth does not exceed 2 feet (0.6 m).
- **“Wave Pool”** means any pool designed to simulate breaking or cyclic waves for purposes of general play. A wave pool is not the same as a surf pool, which generates waves dedicated to the activity of surfing on a surfboard or analogous surfing device commonly used in the ocean and intended for sport as opposed to general play intent for wave pools.

“Pool Deck” See *“Deck.”*

“Pool Slide” See *“Slide.”*

“Public Water Systems” means water systems including community water systems, non-transient/non-community water systems, or transient non-community water systems with exceptions as noted by AHJ and EPA.

“Purge” means to introduce a large volume of outdoor air to flush the interior space.

“Qualified Lifeguard” means an individual who has successfully completed an AHJ-recognized lifeguard training course offered by an AHJ-recognized training agency, holds a current certificate for such training, has met the pre-service requirements, and is participating in continuing in-service training requirements of the aquatic facility.

“Qualified Operator” means an individual responsible for the operation and maintenance of the water and air quality systems and the associated infrastructure of the aquatic facility and who has successfully completed an AHJ-recognized operator training course to operate an aquatic facility offered by an AHJ-recognized training agency and holds a current certificate for such training.

“Raceway” means an enclosed channel of metallic or nonmetallic materials designed expressly for holding wires, cables, busbars, or additional functions as permitted.

“Recessed Steps” means a way of ingress/egress for a pool, similar to a ladder but the individual treads are recessed into the pool wall.

“Recirculation System” means the combination of the main drain, gutter or skimmer, inlets, piping, pumps, controls, surge tank or balance tank to provide pool water recirculation to and from the pool and the treatment systems.

“Reduction Equivalent Dose (*RED*) Bias” means a variable used in UV system validation to account for differences in UV sensitivity between the UV system challenge microbe (*e.g., MS2 virus*) and the actual microbe to be inactivated (*e.g., Cryptosporidium*).

“Re-entrainment” means a situation where the exhaust(s) from a ventilated source such as an indoor aquatic facility is located too close to the air handling system intake(s), which allows the exhausted air to be re-captured by the air handling system, so it is transported directly back into the aquatic facility.

“Responsible Supervisor” means an individual onsite that is responsible for water treatment operations when a “qualified operator” is not onsite at an aquatic facility.

“Reverberation” means the persistence of sound in an enclosed or partially enclosed space after the source of sound has stopped due to repeated reflections from the room surfaces; by extension, in some contexts, the sound that so persists.

“Reverberation Time – RT_{60} ” means, for airborne sound, the time it takes a reverberant sound field to decay 60 dB after the source is interrupted. If an ambient sound field limits the ability to measure 60 dB of decay, then this time can be extrapolated for the measure of the shorter decay.

“Rinse Shower” See “Shower.”

“Robotic Cleaner” means a modular vacuum system consisting of a motor-driven, in-pool suction device, either self-powered or powered through a low voltage cable, which is connected to a deck-side power supply.

“Rope and Float Line” means a continuous line not less than 1/4" (6 mm) in diameter and that is supported by buoys spaced no more than 5 feet apart to provide a visual and physical separation of the pool areas.

“Runout” means that part of a waterslide where riders are intended to decelerate and/or come to a stop. The runout is a continuation of the waterslide flume surface.

“Safety” (*as it relates to construction items*) means a design standard intended to prevent inadvertent or hazardous operation or use (*i.e., a passive engineering strategy*).

“Safety Plan” means a written document that has procedures, requirements and/or standards related to safety which the aquatic facility staff shall follow. These plans include training, emergency response, and operations procedures.

“Safety Team” means any employee of the aquatic facility with job responsibilities related to the aquatic facility’s emergency action plan.

“Safety Vacuum Release System” (*SVRS*) means as defined in 15 USC 8002 (5) “a vacuum release system capable of providing vacuum release at a suction outlet caused by a high vacuum occurrence due to a suction

outlet flow blockage.” A SVRS may be a mechanical device installed on the exposed single main suction pipe before a filtration or feature pump or an electrical device located as an attachment to the filtration or feature pump control system or is integral with the filtration or feature pump or motor itself.

“**Sanitize**” means reducing the level of microbes to that considered safe by public health standards.

“**Saturation Index**” means a mathematical representation or scale representing the ability of water to deposit calcium carbonate, or dissolve metal, concrete, or grout.

“**Secondary Treatment**” means those disinfection processes or systems installed in addition to the standard systems required on all aquatic venues, which are required to be used for increased risk aquatic venues.

“**Shower**” means a device that sprays water on the body.

- “**Cleansing Shower**” means a shower located within a hygiene facility using warm water and soap. The purpose of these showers is to remove contaminants including perianal fecal material, sweat, skin cells, personal care products, and dirt before bathers enter the aquatic venue.
- “**Rinse Shower**” means a shower typically located in the pool deck area with ambient temperature water. The main purpose is to remove dirt, sand, or organic material prior to entering the aquatic venue to reduce the introduction of contaminants and the formation of disinfection byproducts.

“**Skimmer**” means a device installed in the pool wall whose purpose is to remove floating debris and surface water to the filter. They shall include a weir to allow for the automatic adjustment to small changes in water level, maintaining skimming of the surface water.

“**Skimmer Pool**” See “*Pool.*”

“**Skimmer System**” means periodic locations along the top of the pool wall for removal of water from the pool’s surface for treatment.

“**Slide**” means an aquatic feature where users slide down from an elevated height into water.

- “**Drop Slide**” means a slide that drops bathers into the water from a height above the water versus delivering the bather to the water entry point.
- “**Pool Slide**” means a slide having a configuration as defined in 16 CFR Part 1207, or is similar in construction to a playground slide used to allow users to slide from an elevated height to a pool. They shall include children’s (*tot*) slides and all other non- flume slides that are mounted on the pool deck or within the basin of a public swimming pool.
- “**Waterslide**” means a slide that runs into a landing pool or runout through a fabricated channel with flowing water.

“**Slip Resistant**” means surfaces shall have a minimum dynamic coefficient of friction at least equal to the requirements of ANSI A137.1-2012 for that installation as measured by the DCOF AcuTest.

“**Sound Absorption**” means (1) the process of dissipating sound energy and (2) the property possessed by materials, objects, and structures, such as rooms, for absorbing sound energy.

“**Sound Transmission Class**” (*STC*) means a one-number rating of the sound-blocking ability of a partition, door, window, etc., calculated in accordance with ASTM E413 from measurements of one-third-octave band sound pressure levels and sound absorption made in a laboratory and in accordance with ASTM E90.

“**Spa**” See “*Aquatic Venue.*”

“**Special Use Aquatic Venue**” See “*Aquatic Venue.*”

“**Stadium Seating**” See “*Theoretical Peak Occupancy.*”

“**Standard**” means something established by authority, custom, or general consent as a model or example.

“**Storage**” means the condition of remaining in one space for 1 hour or more. Materials in a closed pipe or tube awaiting transfer to another location shall not be considered to be stored.

“**Structural Crack**” means a break or split in the pool surface that weakens the structural integrity of the vessel.

“**Substantial Alteration**” means the alteration, modification, or renovation of an aquatic facility or an aquatic venue where the total cost of the work exceeds 50% of the replacement cost of the aquatic facility or the aquatic venue.

“**Superchlorination**” means the addition of large quantities of chlorine-based chemicals to kill algae, destroy odors, or improve the ability to maintain a disinfectant residual.

“**Supplemental Treatment**” means those disinfection processes or systems which are not required on an aquatic venue for health and safety reasons. They may be used to enhance overall system performance and improve water quality.

“**Surf Pool**” See “*Pool.*”

“**SVRS**” See “*Safety Vacuum Release System.*”

“**Theoretical Peak Occupancy**” means the anticipated peak number of bathers in an aquatic venue or the anticipated peak number of occupants of the decks of an aquatic facility. This is the lower limit of peak occupancy to be used for design purposes for determining services that support occupants. Theoretical peak occupancy is used to determine the number of showers. For aquatic venues, the theoretical peak occupancy is calculated around the type of water use or space:

- “**Agitated Water**” means an aquatic venue with mechanical means (*aquatic features*) to discharge, spray, or move the water's surface above or below the static water line of the aquatic venue so people are standing or playing vertically. Where there is no static water line, movement shall be considered above the deck plane.
- “**Flat Water**” means an aquatic venue in which the water line is static except for movement made by users usually as a horizontal use as in swimming. Diving spargers do not void the flat water definition.
- “**Hot Water**” means an aquatic venue with a water temperature over 90°F (32°C).
- “**Stadium Seating**” means an area of high-occupancy seating provided above the pool level for observation.

“**Therapy Pool**” See “*Pool.*”

“**Toe Ledge**” See “*Underwater Ledge.*”

“**Total Bromine**” means the amount of bromine in the 1 oxidation state, which is the reactive, oxidized form. Commercially available test kits are not capable of distinguishing free bromine (Br_2 , $HOBr$, OBr^-) from combined bromine (*bromamines*). The bromine value specified in test results is the concentration of total bromine.

“**Trichloramine**” means a disinfection byproduct formed when chlorine binds to nitrogenous waste in pool water to form an amine-containing compound with three chlorine atoms (NCl_3). It is a known acute respiratory and ocular irritant. It has low solubility in water and is rapidly released into the air above pools where it can accumulate, particularly in indoor settings.

“**Trihalomethanes**” (*THM*) means chemical compounds in which three of the four hydrogen atoms of methane (CH_4) are replaced by halogen atoms. Trihalomethanes are environmental pollutants, and many are considered carcinogenic.

“**Turnover**” or “**Turnover Rate**” or “**Turnover Time**” means the period of time, usually expressed in hours, required to circulate a volume of water equal to the capacity of the aquatic venue.

“**Underwater Bench**” means a submerged seat with or without hydrotherapy jets.

“**Underwater Ledge**” or “**Underwater Toe Ledge**” means a continuous step in the pool wall that allows swimmers to rest by standing without treading water.

“**UV Transmissivity**” means the percentage measurement of ultraviolet light able to pass through a solution.

“Wading Pool” See *“Pool.”*

“Waterslide” See *“Slide.”*

“Water Quality Testing Device” (*WQTD*) means a product designed to measure the level of a parameter in water. A WQTD includes a device or method to provide a visual indication of a parameter level and may include one or more reagents and accessory items.

“Water Replenishment System” means a way to remove water from the pool as needed and replace with make-up water to maintain water quality.

“Wave Pools” See *“Pool.”*

“Wet Deck” See *“Deck.”*

“Wing Wall / Peninsula” See *“Peninsula / Wing Wall.”*

“Zero Depth Entry” means a sloped entry into a pool from deck level into the interior of the pool as a means of access and egress.

3.0 Cited Standards and Laws

Nothing in this code is intended to exempt an AQUATIC FACILITY or associated AQUATIC VENUES from any applicable local, state, territorial, federal, and tribal laws. Other applicable requirements may include but are not limited to building codes, mechanical codes, plumbing codes, electrical codes, fire codes, FDA Food Code, OSHA requirements, EPA requirements, and the Code of Federal Regulations. Additional permits and inspections may be required based on the requirements of other applicable laws.

Acoustical Society of America (ASA)

- ANSI/ASA S12.60-2010/Part 1 (R2015), Acoustical Performance Criteria, Design Requirements, and Guidelines for Schools, Part 1: Permanent Schools
- ANSI/ASA S12.60-2009/Part 2 (R2014), Acoustical Performance Criteria, Design Requirements, and Guidelines for Schools, Part 2: Relocatable Classroom Factors

Air Conditioning Contractors of America (ACCA)

- ANSI/ACCA 10 Manual SPS-2011 (RA 2017); Manual SPS HVAC Design for Swimming Pools and Spas

Air Conditioning Heating and Refrigeration Institute (AHRI)

- ANSI/AHRI Standard 910 (I-P), 2014 Standard for Performance Rating of Indoor Pool Dehumidifiers
- ANSI/AHRI Standard 920 (I-P), 2020 Standard for Performance Rating of Direct Expansion-Dedicated Outdoor Air System Units

Air Movement Control Association (AMCA)

- AMCA 201-02 (R2011), Fans and Systems

American Coatings Association (ACA)

- Hazardous Materials Identification System (HMIS), 4th Edition

American Concrete Institute (ACI)

- ACI 302.1R-15, Guide to Concrete Floor and Slab Construction

American Heart Association (AHA)

- American Heart Association (AHA) Guidelines for Cardiopulmonary Resuscitation (CPR) and Emergency Cardiovascular Care (ECC)
- 2020 AHA Guidelines Update for CPR and ECC

- www.citizencpr.org

American National Standards Institute (ANSI)

- ANSI/ICC A117.1-2017. Accessible and Usable Buildings and Facilities
- ANSI A137.1:2017 American National Standards Specifications for Ceramic Tile

American National Standards Institute / International Aquatic Foundation (IAF)

- ANSI/IAF-9

American National Standards Institute / International Safety Equipment Association (ISEA)

- ANSI /ISEA Z308.1-2015: American National Standard – Minimum Requirements for Workplace First Aid Kits and Supplies

American Red Cross (ARC)

- American Red Cross, Lifeguarding Manual, 2017

American Safety & Health Institute (ASHI)

- ASHI CPR, AED and Basic First Aid Combination Training, 2018

American Society of Heating, Refrigerating and Air-Conditioning Engineers (ASHRAE)

- ANSI/ASHRAE Standard 62.1-2019: Ventilation for Acceptable Indoor Air Quality
- 2019 ASHRAE Handbook – HVAC Applications
- 2017 ASHRAE Handbook – Fundamentals

American Society of Mechanical Engineers (ASME)

- ASME A112.19.17-2010, Manufactured Safety Vacuum Release Systems (SVRS) for Residential and Commercial Swimming Pool, Spa, Hot Tub, and Wading Pool Suction Systems

ASTM International (formerly American Society for Testing and Materials) (ASTM)

- ASTM E90 – 09 (2016): Standard Test Method for Laboratory Measurement of Airborne Sound Transmission Loss of Building Partitions and Elements
- ASTM E413 – 16 (2016): Classification for Rating Sound Insulation
- ASTM E1477 – 98a (2017): Standard Test Method for Luminous Reflectance Factor of Acoustical Materials by Use of Integrating-Sphere Reflectometers
- ASTM F1346-91 (2010): Standard Performance Specification for Safety Covers and Labeling Requirements for All Covers for Swimming Pools, Spas and Hot Tubs
- ASTM F2285-04 (2016)e1: Standard Consumer Safety Performance Specification for Diaper Changing Tables for Commercial Use
- ASTM 2374-17 (2017): Standard Practice for Design, Manufacture, Operation, and Maintenance of Inflatable Amusement Devices
- ASTM F2376-117a (2021): Standard Practice for Classification, Design, Manufacture, Construction and Operation of Water Slides Systems
- ASTM F2387-04 (2012): Standard Specification for Manufactured Safety Vacuum Release Systems (SVRS) for Swimming Pools, Spas and Hot Tubs
- ASTM F2461-16e1 (2016): Standard Practice for Manufacture, Construction, Operation and Maintenance of Aquatic Play Equipment

Americans with Disabilities Act Accessibility Guidance (ADAAG)

- 2010 ADA Standards for Accessible Design

Association of Pool and Spa Professionals (APSP)

- ANSI/APSP/ICC-1 2014, American National Standard for Public Swimming Pools
- ANSI/APSP-9 2005, American National Standard for Aquatic Recreation Facilities
- ANSI/APSP-16 2017, American National

Standard for Suction Fittings for Use in Swimming Pools, Wading Pools, Spas, and Hot Tubs

Canadian Standards Association (CSA)

- Z83.8-2016/CSA 2.6-2016 – Gas Unit Heaters, Gas Packaged Heaters, Gas Utility Heaters, and Gas-Fired Duct Furnaces
- ANSI Z21.13-2017/CSA 4.9-2017 – Gas-Fired Low Pressure Steam and Hot Water Boilers
- CSA 22.1 – 2018 Canadian Electrical Code, Part I (24th Edition), Safety Standard for Electrical Installations
- CAN/CSA-C22.2 NO. 0-10 (R2015) – General Requirements – Canadian Electrical Code, Part II

Caring for Our Children (CFOC): National Health and Safety Performance Standard

- National Health and Safety Performance Standards; Guidelines for Early Care and Education Programs, 3rd Edition, 2011 (revised October 1, 2015)
- Also known as *Caring for Our Children*, 3rd Edition (CFOC3)
- <https://nrckids.org>

Chlorine Institute (CI)

- Pamphlet 82; Recommendations for Using 100 & 150 Pound Chlorine Cylinders at Swimming Pools, Edition 3, January 2015

Citizen CPR Foundation (CCPRF)

- ECCU Emergency Cardiovascular Care Update Conference
- www.citizencpr.org

Conference for Food Protection (CFP)

- Standards for Accreditation of Food Protection Managers Certification Programs, 2020 Edition

Consumer Product Safety Commission (CPSC)

- National Electronic Injury Surveillance System (NEISS) Data
- 15 USC Chapter 106, Pool and Spa Safety (as amended to 2014): Virginia Graeme Baker Pool and Spa Safety Act (VGBA)

- Interpretations and Staff Guidelines for the Virginia Graeme Baker Pool and Spa Safety Act
- 16 CFR 1207 – Safety Standard for Swimming Pool Slides

Deutsches Institut für Normung (DIN)

- DIN 19643-1: 2012-11 Treatment of Water of Swimming Pools and Baths – Part 1: General Requirements
- DIN 19643-2: 2012-11 Treatment of Water of Swimming Pools and Baths – Part 2: Combinations of Process with Fixed Bed Filters and Precoat Filters
- DIN 19643-3: 2012-11 Treatment of Swimming Water of Swimming Pools and Baths – Part 3: Combinations of Process with Ozonation
- DIN 19643-4: 2012-11 Treatment of Swimming Water of Swimming Pools and Baths – Part 4: Combinations of Process with Ultrafiltration
- DIN 19643-5: 2012-11 Treatment of Swimming Water of Swimming Pools and Baths – Part 5: Combinations of Process Using Bromine as Disinfectant, Produced by Ozonation of Bromide Rich Water

Deutscher Verein des Gas- und Wasserfaches e.V. – Technisch wissenschaftlicher Verein (DVGW)

- German Technical and Scientific Association for Gas and Water

Environmental Protection Agency (EPA)

- EPA 815-R-06-007: Ultraviolet Disinfectant Guidance Manual for the Final Long Term 2 Enhanced Surface Water Treatment Rule, November 2006
- EPA 815-R-99-014: Alternate Disinfectants and Oxidants Guidance Manual, April 1999
- 42 USC Chapter 116, Emergency Planning and Community Right-to-Know Act (EPCRA) of 1986
- 40 CFR 141, EPA, 816-F-09-004: National Primary Drinking Water Regulations, May 2009
- EPA 550-B-21-001: List of Lists – Consolidated List of Chemicals Subject to the Emergency Planning and Community Right-To-Know Act (EPCRA), Comprehensive Environmental Response,

Compensation and Liability Act (CERCLA) and Section 112(r) of the Clean Air Act, April 2022

- <https://www.epa.gov/epcra/consolidated-list-lists>
- OSWER 90-008.1, June 1990, EPA Chemical Emergency Preparedness and Prevention Advisory, Swimming Pool Chemicals: Chlorine
- 7 USC 136 et. seq. (1996), Federal Insecticide, Fungicide, and Rodenticide Act (FIFRA)
- 40 CFR Subchapter E – Pesticide Programs

European Standard (ES)

- EN 13451-11:2014 – Swimming Pool Equipment – Part 11: Additional Specific Safety Requirements and Test Methods for Moveable Pool Floors and Moveable Bulkheads. (Also known as BS EN 13451-11, CSN EN 13451-11, or DIN EN 13451-11)
- BS EN 60268-1:2011 Sound System Equipment. Objective Rating of Speech Intelligibility by Speech Transmission Index (British Standard)

Fédération Internationale de Natation Amateur (FINA)

- Facilities Rules 2017–2021, 22 September 2017

Food and Drug Administration (FDA)

- Food Code: 2017 Recommendations of the United States Public Health Service Food and Drug Administration

Hazardous Materials Identification System (HMIS)

- See American Coatings Association above

Health Canada Pest Management Regulatory Agency (PMRA)

- Pest Control Products Act (S.C. 2002, c. 28)
- Pesticide Product Information Database

Illuminating Engineering Society of North America (IESNA)

- IES RP-6-15 Sports and Recreational Area Lighting (2015)
- The Lighting Handbook, 10th Edition (2011)

Institute of Electrical and Electronics Engineers (IEEE)

- IEEE Std 241-1990 – IEEE Recommended Practice for Electric Power Systems in Commercial Buildings (reaffirmed in 1997)

International Association of Electrical Inspectors (IAEI)

- Soares Grounding and Bonding, 13th Edition, 2017

International Association of Plumbing and Mechanical Officials (IAPMO)

- IAPMO/ANSI UMC 1 2018 (2018 Uniform Mechanical Code)
- IAPMO/ANSI UPC 1 2018 (2018 Uniform Plumbing Code)
- IAPMO/ANSI USPSHTC 1 2018 (2018 Uniform Swimming Pool, Spa, and Hot Tub Code)

International Code Council (ICC)

- ICC 300-2017 IS-BLE: 2017 ICC Standard on Bleachers, Folding and Telescopic Seating, and Grandstands
- ICC/ANSI A117.1-2017 Standard for Accessible and Usable Buildings and Facilities
- 2018 International Building Code (IBC)
- 2018 International Fire Code (IFC)
- 2018 International Mechanical Code (IMC)
- 2018 International Plumbing Code (IPC)
- 2018 International Swimming Pool and Spa Code (ISPSC)

International Liaison Committee on Resuscitation (ILCOR)

- 2015 International Consensus on Cardiopulmonary Resuscitation and Emergency Cardiovascular Care With Treatment Recommendations (CoSTR)
- www.ilcor.org

International Organization for Standardization (ISO)

- ISO/IEC Guide 50:2014. Safety Aspects – Guidelines for Child Safety in Standards and Other Specifications
- ISO9000:-2015; Quality management

systems – Fundamentals and vocabulary

National Collegiate Athletic Association (NCAA)

- 2017–18 and 2018–19 NCAA Men’s and Women’s Swimming and Diving Rules

National Electrical Manufacturers Association (NEMA)

- NEMA 250-2014, Enclosures for Electrical Equipment (1,000 V Maximum)
- ANSI/NEMA Z535, 2011 (R2017): Safety Alerting Standards

National Federation of State High School Associations (NFHS)

- 2021–22 NFHS Swimming and Diving Rules Book

National Fire Protection Association (NFPA)

- NFPA 1: Fire Code, 2018 Edition
- ANSI Z223.1/NFPA 54: National Fuel Gas Code, 2018 Edition
- NFPA 70: National Electrical Code (NEC), 2020 Edition
- NFPA 70: National Electrical Code (NEC) Handbook
- NFPA 211: Standard for Chimneys, Fireplaces, Vents, and Solid Fuel-Burning Appliances, 2016 Edition
- NFPA 400: Hazardous Materials Code, 2016 Edition
- NFPA 5000: Building Construction and Safety Code, 2018 Edition
- NFPA 652: Standard on the Fundamentals of Combustible Dust, 2016 Edition
- NFPA 704: Standard System for the Identification of the Hazards of Materials for Emergency Response, 2017 Edition

National Institute for Occupational Safety and Health (NIOSH)

- NIOSH Pocket Guide to Chemical Hazards, September 2007, (NPG) (DHHS (NIOSH) Publication No, 2005-149)
- 42 CFR Part 84, Approval of Respiratory Protective Devices, 1995
- Certified Equipment List (CEL)

National Oceanic and Atmospheric Administration (NOAA)

- NOAA Technical Memorandum ERL PMEL-67, Eyeball Optics of Natural Waters: Secchi Disk Science, Rudolph W. Preisendorfer, Pacific Marine Environmental Laboratory, Seattle, WA, April 1986.

National Recreation and Park Association (NRPA)

- Aquatic Facility Operator Manual, 7th Edition

National Swimming Pool Foundation (NSPF)

- Pool & Spa Operator™ Handbook, 2017 Edition

NSF International (NSF)

- NSF/ANSI 14 - 2016b, Plastics Piping System Components and Related Materials
- NSF/ANSI 50 - 16a, Equipment for Swimming Pools, Spas, Hot Tubs and Other Recreational Water Facilities (2017)
- NSF/ANSI 60 – 2020, Drinking Water Treatment Chemicals – Health Effects
- NSF/ANSI 61–2020, Drinking Water System Components – Health Effects

Occupational Safety and Health Administration (OSHA)

- 29 CFR 1910.304 Wiring design and protection
- 29 CFR 1910.1000 Air Contaminants
- 29 CFR 1910.1030 Bloodborne Pathogens
- 29 CFR 1910.1200 Hazard Communication
- 29 CFR 1910.1200(g) Safety Data Sheets (SDS)

Österreichisches Normungsinstitut (ÖNORM)

- Austrian Standards Institute

Pool Water Treatment Advisory Group (PWTAG)

- Swimming Pool Water: Treatment and Quality Standards for Pools and Spas, 3rd Edition, 2017

Propane Education and Research Council (PERC)

- Instruction Sheet IV: Identifying and Correcting Burner Problems

Sheet Metal and Air Conditioning Contractors' National Association (SMACNA)

- SMACNA HVAC Systems Duct Design, 4th Edition, 2006

Underwriters Laboratories (UL)

- UL 50 2015-10-16 Enclosures for Electrical Equipment, Non-Environmental Considerations
- UL 50E 2020-10-16 Enclosures for Electrical Equipment, Environmental Considerations
- UL 379 2013-06-19 Standard for Power Units for Fountain, Swimming Pool, And Spa Luminaries
- UL 399 2017-03-20 Standard for Drinking-Water Coolers
- UL 508 2018-01-28 Standard for Industrial Control Equipment
- UL 676 2015-08-10 Standard for Underwater Luminaries and Submersible Junction Boxes
- UL 727 2018-01-31 Standard for Oil-Fired Central Furnaces
- UL 1081 2016-08-09 Standard for Swimming Pool Pumps, Filters, and Chlorinators
- UL 1241 2003-06-11 Standard for Junction Boxes for Swimming Pool Luminaries
- UL 1777 2015-10-02 Standard for Chimney Liners
- UL 1995 2015-07-31 Heating and Cooling Equipment
- UL 2075 2013-03-05 Standard for Gas and Vapor Detectors and Sensors
- UL 2452 2006-04-21 Outline of Investigation for Electric Swimming Pool and Spa Cover Operators
- UL 2759 2011-09-26 Standard for Sustainability for Hard Surface Cleaners
- UL 2818 2013-03-29 GREENGUARD Certification Program for Chemical Emissions for Building Materials, Finishes, and Furnishings
- UL 8750 2015-09-15 Standard for Light

Emitting Diode (LED) Equipment for Use in Lighting Products

- UL 60335-2-1000 2017-09-29 Standard for Household and Similar Electrical Appliances: Particular Requirements for Electrically Powered Pool Lifts
- UL 61010-1 2012-05-11 Safety Requirements for Electrical Equipment for Measurement, Control, and Laboratory Use – Part 1: General Requirements

U.S. Army Corps of Engineers (USACE)

- USACE Air Leakage Test Protocol for Building Envelopes - Version 3: May 11, 2012
- http://www.wbdg.org/FFC/ARMYCOE/usa_ce_airleakagetestprotocol.pdf

U.S. Codes: State Codes

- California Health and Safety Code (HSC), Article 4. Lead Materials, Section 116875, January 1, 2009
- Florida Administrative Code, Chapter 64E-9 Public Swimming Pools and Bathing Places, July 20, 2016
- Hawaii Administrative Rules, Title 11, Chapter 10, Public Swimming Pools, July 15, 2002
- Illinois Swimming Facility Code, Title 77, Section 820, October 4, 2013
- New York Uniform Code, Title 10, Part 6, Subpart 6-1 Swimming Pools, July 6, 2011
- Ohio Administrative Code, Chapter 3701-31 Public Swimming Pools or Spas, April 1, 2011
- Oregon Administrative Rules, Chapter 333 – Division 60, Public Swimming Pools, September 1, 2014
- Texas Administrative Code, Title 25, Chapter 265, Subchapter L, Public Swimming Pools and Spas, September 1, 2004

- Wisconsin Administrative Code, Chapter SPS 390, Design and Construction of Public Swimming Pools and Water Attractions, March 1, 2009

U.S. Coast Guard

- 33 CFR 175.15, Personal Floatation Devices, September 22, 2014

U.S. Department of Energy (USDOE)

- USDOE Air Leakage Testing and Air Sealing in Existing Multifamily Units, October 2012
- https://www1.eere.energy.gov/buildings/publications/pdfs/building_america/air_sealing_multifamily.pdf

USA Diving

- USA Diving Competitive and Technical Rules, 2018

USA Swimming

- USA Swimming 2020 Rulebook

Virginia Graeme Baker Pool and Spa Safety Act (VGB Act)

- 15 USC Chapter 106, Pool and Spa Safety (as amended to 2014)
- Available at: <https://www.poolsafely.gov/wp-content/uploads/2016/04/pssa.pdf>

Water Environment Federation/International Ultraviolet Association (WEF/IUVA)

- Ultraviolet Disinfection for Wastewater
- ISBN: 978-1-57278-312-6 (April 2015)

World Health Organization (WHO)

- Guidelines for Safe Recreational Water Environments – Volume 2 Swimming Pools and Similar Environments, 2006

YMCA of the USA (YMCA)

- On the Guard: The YMCA Lifeguard Manual, 2016 Edition

4.0^A Aquatic Facility Design Standards and Construction

The provisions of MAHC Chapter 4 (*Aquatic Facility Design Standards and Construction*) apply to construction of a new AQUATIC FACILITY or AQUATIC VENUE or SUBSTANTIAL ALTERATION to an existing AQUATIC FACILITY or AQUATIC VENUE, unless otherwise noted.

Note: Section numbers with superscript “A” (e.g., 4.0^A) denote a corresponding discussion in the Annex to the Model Aquatic Health Code.

4.1 Plan Submittal

4.1.1 Plan Submittal

4.1.1.1 Purpose AQUATIC FACILITY construction plans shall be designed to provide sufficient clarity to indicate the location, nature, and extent of the work proposed.

4.1.1.2 Conform AQUATIC FACILITY construction plans shall show in detail that the AQUATIC FACILITY will conform to the provisions of this CODE and all applicable local, state, territorial, federal, and tribal laws, as determined by the AHJ and to protect the health and SAFETY of the facility’s BATHERS and PATRONS.

4.1.1.3 Approved Plans No person shall begin to construct a new AQUATIC FACILITY or shall SUBSTANTIALLY ALTER an existing AQUATIC FACILITY without first having the construction plans detailing the construction or SUBSTANTIAL ALTERATION submitted to and approved by the AHJ.

4.1.1.4 Plan Preparation All plans shall be prepared by a DESIGN PROFESSIONAL proficient in the application of this CODE and all applicable local, state, territorial, federal, and tribal laws relevant to the project and who shall apply this CODE and all applicable laws when preparing project plans.

4.1.1.5 Required Statements All construction plans shall include the following statements:

- 1) “The proposed aquatic facility and all equipment shall be constructed and installed in conformity with the approved plans and specifications or approved amendments,” and
- 2) “No substantial alteration, changes, additions, or equipment not specified in the approved plans can be made or added until the plans for such substantial alteration, changes, additions, or equipment are submitted to and approved by the AHJ.”

4.1.2 Content of Design Report

4.1.2.1 Basis of Design Report

4.1.2.1.1^A Names / Addresses AQUATIC FACILITY plans shall include the name, address, and contact information for the owner, designer, and builder if available at the time of submission.

4.1.2.1.2 Site Information AQUATIC FACILITY plans shall include site information indicating at a minimum the location of all utilities, wells, topography, natural water features, and potential sources of surface drainage and pollution which have the potential to affect the proposed AQUATIC FACILITY.

4.1.2.1.3 Plot Plan AQUATIC FACILITY plans shall include a site plot plan including:

- 1) A general map and detailed scaled drawings of the AQUATIC FACILITY site plan or floor plan with detailed locations of the AQUATIC VENUES and AQUATIC FEATURES; and
- 2) The locations of all water supply facilities, sources of drinking water, public or private sewers, and relative elevations of paved or other walkways and the EQUIPMENT ROOM floor shall be shown on the plans with the elevations of storm and sanitary sewer inverts and street grade.

4.1.2.2 Plans and Specifications

4.1.2.2.1 Drawings Detailed scaled and dimensional drawings for each individual AQUATIC

VENUE shall include an AQUATIC VENUE area plan and layout plan along with dimensioned longitudinal and transverse cross sections of the AQUATIC VENUE.

4.1.2.2.1.1 Operating Conditions The design documents shall include a record of operating conditions (*water temperature(s), space temperature, space relative humidity, space dew point*) and intended use for each type of VENUE (*FLAT WATER, AGITATED WATER, HOT WATER*) accepted by both the design engineer and owner/operator.

4.1.2.2.2 Aquatic Venue Attributes Detailed scaled and dimensional drawings for each individual AQUATIC VENUE shall include location and type of:

- 1) INLETS;
- 2) Overflows;
- 3) Drains;
- 4) Suction outlets;
- 5) Overflow gutters or devices;
- 6) Piping;
- 7) Designed POOL water elevation;
- 8) AQUATIC FEATURES such as ladders, stairs, diving boards, SLIDES, and play features;
- 9) Lighting;
- 10) POOL markings; and
- 11) Surface materials

4.1.2.2.3 Area Design Detailed scaled and dimensional drawings of the AQUATIC FACILITY and for each individual AQUATIC VENUE, as appropriate, shall include location and type of:

- 1) Design of AQUATIC VENUE ENCLOSURE including walls, fencing, entry and exit doors and gates, self-closing and latching hardware, and locks;
- 2) Design of DECK, including paving materials, DECK slope, and DECK drains;
- 3) Paved walkways and other hardscape features;
- 4) SLIP-RESISTANT flooring;
- 5) AQUATIC VENUE area finishes;
- 6) Drinking fountains or other sources of drinking water;
- 7) Entries and exits;
- 8) Hose bibs;
- 9) Fences;
- 10) Telephones; and
- 11) Area lighting.

4.1.2.2.4 Aquatic Venue Recirculation and Treatment Design Detailed scaled and dimensional drawings for each individual AQUATIC VENUE shall contain a flow diagram showing the location, plan, elevation, and schematics of:

- 1) Filters;
- 2) Pumps;

- 3) Chemical feeders and interlocks;
- 4) Chemical controllers and interlocks;
- 5) SECONDARY TREATMENT, if required;
- 6) Supplemental disinfection systems, if installed;
- 7) Ventilation devices or AIR HANDLING SYSTEMS;
- 8) Heaters;
- 9) Surge tanks, including operating levels;
- 10) BACKFLOW prevention assemblies and air gaps;
- 11) Valves;
- 12) Piping;
- 13) Flow meters;
- 14) Gauges;
- 15) Thermometers;
- 16) Test cocks;
- 17) Sight glasses; and
- 18) Drainage system for the disposal of AQUATIC VENUE water and filter wastewater.

4.1.2.2.5 **Equipment Room Design** Detailed scaled and dimensional drawings for each individual AQUATIC VENUE shall contain a schematic layout of the AQUATIC VENUE EQUIPMENT ROOM OR AREA showing accessibility for installation and maintenance.

4.1.2.2.6 **Chemical Storage Space Design** Detailed scaled and dimensional drawings for each individual AQUATIC VENUE shall contain a schematic layout of the AQUATIC FACILITY CHEMICAL STORAGE SPACE(S).

4.1.2.2.7 **Hygiene Facility Design** Detailed scaled and dimensional drawings for each AQUATIC FACILITY shall show the location and number of all available HYGIENE FACILITIES provided including dressing rooms, lockers and basket STORAGE, SHOWERS, lavatory, toilet FIXTURES, and DIAPER-CHANGING STATIONS.

4.1.2.3 **Technical Specifications**

4.1.2.3.1^A **Accompanying Drawings** Technical specifications for the construction of each AQUATIC VENUE and all appurtenances shall accompany the drawings for the AQUATIC FACILITY plans.

4.1.2.3.2^A **Technical Details** The following technical specifications shall be provided for each AQUATIC FACILITY:

- 1) Water temperatures for each AQUATIC VENUE;
- 2) Effective surface area of each AQUATIC VENUE;
- 3) Space design
 - a. Listing of each room size (length, width, height).
 - b. Statement that a vapor BARRIER is included in the construction of all interior and exterior wall and ceiling surfaces.
 - c. Statement that all windows are at least double pane and include a thermal break along with the U value, and

- d. A listing of all wall and ceiling construction R values
- 4) Design/desired dry bulb and dew point temperatures;
 - 5) Design/desired relative humidity;
 - 6) Type of water treatment; and
 - 7) PERIMETER DECK and POOL DECK, which are the same as the WET DECK area defined in the ASHRAE 62.1.2019 Standard, which defines this area as the “area surrounding the POOL surface that is capable of being wetted during use or when POOL is occupied.”

4.1.2.3.2.1 Details Not Shown on Plans Each AQUATIC VENUE shall include all construction details not shown on the plans that relate to the AQUATIC FACILITY:

4.1.2.3.2.2^A Intended Use During the design of the ventilation and CLIMATE CONTROL SYSTEMS for INDOOR AQUATIC FACILITIES, the DESIGN PROFESSIONALS (engineers and architects) shall consult with and obtain input from the owner/operator to address intended uses, type of AQUATIC VENUES (FLAT WATER, AGITATED WATER, HOT WATER) and intended typical operating water temperatures, space air temperature, and relative humidity.

4.1.2.3.2.2.1 Design Criteria Document A design criteria document shall be written as a result of these consultations, signed by all parties involved and become a permanent document of the project specifications and owner’s manual.

4.1.2.3.3 Water Sources The technical specifications for each AQUATIC FACILITY shall include the sources of all water supplies.

4.1.2.3.4 Area and Volume Technical specifications shall include the water surface area and volume of each AQUATIC VENUE and associated water features, if applicable.

4.1.2.3.5^A Theoretical Peak Occupancy The technical specifications for each AQUATIC FACILITY and each AQUATIC VENUE shall include THEORETICAL PEAK OCCUPANCY, respectively.

4.1.2.3.5.1 Used for Designing Systems The THEORETICAL PEAK OCCUPANCY for ventilation air for an AQUATIC VENUE shall be used for designing systems that serve BATHERS and PATRONS.

4.1.2.3.5.2 Incorporate Non-Water Related Areas The THEORETICAL PEAK OCCUPANCY for an AQUATIC FACILITY shall be used for designing systems that serve BATHERS and PATRONS and shall incorporate non-water related areas such as DECKS and other adjacent portions of the AQUATIC FACILITY not associated with the AQUATIC VENUE.

4.1.2.3.5.3 Calculating Theoretical Peak Occupancy The THEORETICAL PEAK OCCUPANCY shall be calculated by dividing the surface area in square feet of the AQUATIC VENUE by the density factor (*D*) that fits the specific AQUATIC VENUE being considered.

THEORETICAL PEAK OCCUPANCY = AQUATIC VENUE Surface Area / *D*

The density factors (*D*) are Water/BATHER-related:

- 1) FLAT WATER density factor = 20 ft² (1.9 m²) per BATHER.
- 2) AGITATED WATER density factor = 15 ft² (1.4 m²) per BATHER.
- 3) HOT WATER density factor = 10 ft² (0.9 m²) per BATHER.
- 4) WATERSLIDE LANDING POOL density factor = manufacturer-established capacity at any given time.
- 5) INTERACTIVE WATER PLAY water density factor = 10 ft² (0.9 m²) per BATHER on surface.
- 6) SURF POOL density factor = manufacturer-established capacity at any given time.

Non-water/PATRON-related:

- 7) DECK density factor = 50 ft² (4.6 m²) per BATHER.
- 8) STADIUM SEATING density factor = 6.6 ft² (0.6 m²) per BATHER.

4.1.2.3.5.3.1 Density Factor Modification The density factors in MAHC 4.1.2.3.5.3 may be modified for higher BATHER or PATRON density, but they shall not be modified to result in less BATHERS per square feet than listed for the factors in MAHC 4.1.2.3.5.3.

4.1.2.3.5.3.2 Aquatic Facility Theoretical Peak Occupancy The THEORETICAL PEAK OCCUPANCY for an AQUATIC FACILITY shall be determined by adding the calculations for each AQUATIC VENUE in the AQUATIC FACILITY.

4.1.2.3.6 Equipment Characteristics and Rating The technical specifications and supplemental engineering data for each AQUATIC FACILITY and each AQUATIC VENUE shall include:

- 1) Detailed information on the type, size, operating characteristics, and rating of all mechanical and electrical equipment;
- 2) Hydraulic computations for head loss in all piping and recirculation equipment;
- 3) Pump curves that demonstrate that the selected recirculation pump(s) are adequate for the calculated required flows; and
- 4) For INDOOR AQUATIC FACILITIES, documentation that demonstrates that the INDOOR AQUATIC FACILITY is designed to meet the acoustic design criteria contained in MAHC 4.6.11.
- 5) Documentation per MAHC 4.7.3.2.2.3 to demonstrate that the selected disinfectant feeders/equipment are of sufficient size and capacity, including evaluation of the CHLORINE demand factors in MAHC 4.7.3.2.2.2.1.

4.1.2.3.7 Recirculation Rate and Turnover The technical specifications for each AQUATIC VENUE shall include the recirculation rate and TURNOVER TIME.

4.1.2.3.8 Filter Media The technical specifications for each AQUATIC VENUE shall include information on the filter media such as diatomaceous earth, sand, gravel, or other approved material.

4.1.2.3.9 Equipment Specifications The technical specifications for each INDOOR AQUATIC FACILITY shall include information on each piece of equipment associated with that INDOOR AQUATIC FACILITY. For climate control equipment, the specifications shall include the following items at a minimum: sensible cooling capacity, sensible heating capacity, MOISTURE REMOVAL CAPACITY (MRC) in lbs/hr, MOISTURE REMOVAL EFFICIENCY (MRE) as listed in the AHRI Standard 920-2020 Performance Rating of Direct Expansion-Dedicated Outdoor Air System Units or AHRI Standard 910-2014 Performance Rating of Indoor Pool Dehumidifiers, CFM of outside air, CFM of exhaust air, CFM of supply air, voltage, power requirements, and design temperature and humidity.

4.1.2.3.10 Safety Equipment Specifications The technical specifications for each AQUATIC FACILITY shall include information on all aquatic safety equipment.

4.1.2.3.11 Design for Risk Management The layout for zones of PATRON surveillance as specified in MAHC 6.3.3.1.1 shall be included and must show features or design configurations that can impact PATRON surveillance.

4.1.2.3.12 Other Specifications The technical specifications for each AQUATIC FACILITY and each AQUATIC VENUE shall include additional information related to the project requested by the AHJ for the purposes of the construction of the AQUATIC FACILITY and each AQUATIC VENUE and all appurtenances.

4.1.2.3.13 Air Filter Media The air filters used should be suitable for elevated humidity levels.

4.1.3^A Plan Approval

4.1.3.1 New Construction

4.1.3.1.1 Approval Limitations The AHJ shall clearly state in its construction approval documents the limitations of their approval.

4.1.3.1.2 Other Approvals The approval shall also state that it is independent of all other required approvals such as Building, Zoning, Fire, Electrical, Structural, and any other approvals as required by all applicable local, state, territorial, federal, and tribal laws and the applicant must separately obtain all other required approvals and permits.

4.1.3.1.3 Plan Review Coordination The AHJ shall coordinate their AQUATIC FACILITY plan review and communicate their approval with the owner's representative and DESIGN PROFESSIONALS associated with an AQUATIC FACILITY construction.

4.1.3.1.4 Plan Review Report The AHJ shall provide a plan submission compliance review list to the AQUATIC FACILITY owner with the following information:

- 1) Categorical items marked satisfactory, unsatisfactory, not applicable, or insufficient information;
- 2) A comment section, keyed to the compliance review list, shall detail unsatisfactory and insufficient findings;
- 3) Indication of the AHJ approval or disapproval of the AQUATIC FACILITY construction plans;
- 4) In the case of a disapproval, specific reasons for disapproval, and procedure for resubmittal; and
- 5) Reviewer's name, signature, and date of review.

4.1.3.1.5 Plans Maintained The AQUATIC FACILITY owner shall maintain at least one set of their own approved plans made available to AHJ on file for as long as the AQUATIC FACILITY is in operation.

4.1.3.2 Non-Substantial Alterations

4.1.3.2.1 Alteration Review The AQUATIC FACILITY owner planning a NON-SUBSTANTIAL ALTERATION shall contact the AHJ to review proposed changes prior to starting the NON-SUBSTANTIAL ALTERATION.

4.1.3.2.2 Alteration Scope The AQUATIC FACILITY operator shall consult with the AHJ to determine if new or modified plans must be submitted for plan review and approval for other NON-SUBSTANTIAL ALTERATIONS proposed.

4.1.3.3^A Replacements

4.1.3.3.1 Replacement Approval Prior to replacing equipment, the AQUATIC FACILITY owner shall submit technical verification to the AHJ that all replacement equipment is equal to that which was originally approved and installed.

4.1.3.3.2 Replacement Equipment Equivalency The replacement of pumps, filters, feeders, controllers, SKIMMERS, flow-meters, valves, or other similar equipment with identical or substantially similar equipment may be done without submission to the AHJ for approval of new or altered AQUATIC FACILITY plans.

4.1.3.3.3 Emergency Replacement In emergencies, the replacement may be made prior to receiving the AHJ's approval, with the owner accepting responsibility for proper immediate replacement, if the equipment is not deemed equivalent by the AHJ.

4.1.3.3.3.1 Documentation Where emergency replacements are installed as per MAHC 4.1.3.3.3, the owner shall submit documentation for review and approval of the replacement to the AHJ within 45 days.

4.1.3.3.4 Replacement Record Maintenance The AHJ shall provide the AQUATIC FACILITY owner written approval or disapproval of the proposed replacement equipment's equivalency.

4.1.3.3.5 Documentation Documentation of proposed, approved, and disapproved replacements shall be maintained in the AHJ's AQUATIC FACILITY files.

4.1.4^A Compliance Certificate

4.1.4.1 Construction Compliance Certificate A certificate of construction compliance shall be submitted to the AHJ for all AQUATIC FACILITY plans for new construction and SUBSTANTIAL ALTERATIONS requiring AHJ approvals.

4.1.4.2 Certificate Preparation This certificate shall be prepared by a DESIGN PROFESSIONAL and be within the scope of their practice as defined by the local, state, territorial, federal, and tribal laws governing professional practice within the jurisdiction of the permit issuing official.

4.1.4.3 Certificate Statement The certificate shall also include a statement that the AQUATIC FACILITY, all equipment, and appurtenances have been constructed and/or installed in accordance with approved plans and specifications.

4.1.4.4^A Systems Commissioning If commissioning or testing reports for systems such as AQUATIC FACILITY lighting, air handling, recirculation, filtration, and/or DISINFECTION are conducted, then those reports shall be included in furnished documentation.

4.1.4.5 Maintenance Documentation of AQUATIC FACILITY new construction or SUBSTANTIAL ALTERATION plan compliance shall be maintained in the AHJ's AQUATIC FACILITY files.

4.1.5 Construction Permits

4.1.5.1 Building Permit for Construction Applicable construction permits shall be obtained before any AQUATIC FACILITY may be constructed.

4.1.5.2 Remodeling Building Permit A construction permit or other applicable permits may be required from the AHJ before SUBSTANTIAL ALTERATION of an AQUATIC FACILITY.

4.1.5.3 Permit Issuance The AHJ shall issue a permit to the owner to operate the AQUATIC FACILITY:

- 1) After receiving a certificate of completion from the DESIGN PROFESSIONAL verifying information submitted and
- 2) When new construction, SUBSTANTIAL ALTERATIONS, or annual renewal requirements of this CODE have been met.

4.1.5.4 Permit Denial The permit (*license*) to operate may be withheld, revoked, or denied by the AHJ for noncompliance of the AQUATIC FACILITY with the requirements of this CODE, and the owner will be provided:

- 1) Specific reasons for disapproval and procedure for resubmittal;
- 2) Notice of the rights to appeal this denial and procedures for requesting an appeal; and
- 3) Reviewer's name, signature, and date of review and denial.

4.1.5.5 Documentation Documentation of AQUATIC FACILITY permit renewal or denial shall be maintained in the AHJ's AQUATIC FACILITY files.

4.1.5.6 Suspension or Revocation of Construction Permit The AHJ shall revoke a permit or approval issued under the provisions of this CODE in case of any false statement or misrepresentation of fact in the application or on the construction documents on which the approval was based.

4.1.5.7 Stop Work Orders Upon notice from the AHJ, work on any system that is being performed contrary to the provisions of this CODE or in a dangerous or unsafe manner shall immediately cease. Such

notice shall be in writing and shall be given to the owner of the property, the owner's authorized agent, or to the person performing the work. The notice shall state the condition under which work is authorized to resume.

4.1.5.7.1 Emergency Stop Work Orders When an emergency exists, the AHJ shall not be required to give a written notice prior to stopping the work.

4.2 Materials

4.2.1 Aquatic Venues

4.2.1.1 Construction Material AQUATIC VENUES shall be constructed of reinforced concrete or impervious and structurally sound material(s), which provide a smooth, easily cleaned, watertight structure capable of withstanding the anticipated stresses/loads for full and empty conditions taking into consideration climatic, hydrostatic, seismic, and the integration of the AQUATIC VENUE with other structural conditions and as required by applicable CODES.

4.2.1.2 Durability All materials shall be inert, non-toxic, resistant to corrosion, impervious, enduring, and resistant to damages related to environmental conditions of the installation region.

4.2.1.3 Areas Subject to Freezing Where located in areas subject to freezing, AQUATIC VENUES and appurtenances shall be designed to protect against damage due to freezing.

4.2.1.4 Competitive Pools Competitive or lap POOLS may have lane markings and end wall targets installed in accordance with FINA, NCAA, USA Swimming, NFHS, or other recognized STANDARD.

4.2.1.5^A Design Parameters Any graphics, color, or finish incorporated into the construction of a POOL or painted on the floor or walls shall not prevent the detection of a BATHER in distress, algae, sediment, or other objects in the AQUATIC VENUE.

4.2.1.6 Watertight POOLS shall be designed in such a way to maintain their ability to retain the designed amount of water.

4.2.1.7^A Smooth Finish All vertical walls shall have a durable finish suitable for regular scrubbing and cleaning at the waterline.

4.2.1.7.1 Daily Cleaning The finish shall be able to withstand daily brushing, scrubbing, and cleaning of the surface in accordance with the manufacturer's recommendations.

4.2.1.7.2 Skimmer Pools SKIMMER POOLS shall have a 6 inch (152 mm) to 12 inch (305 mm) high waterline finish that meets the requirements of MAHC 4.2.1.7 and 4.2.1.7.1.

4.2.1.7.3 Gutter / Perimeter Overflow Systems Gutter or perimeter overflow systems shall have a minimum finish height of 2 inches (51 mm) that meets the requirements of MAHC 4.2.1.7 and 4.2.1.7.1.

4.2.1.7.4 Dark Colors If dark colors in excess of what is required in MAHC 4.5.11 of this CODE are used for the POOL finish, these colors shall not extend more than 12 inches (305 mm) below the waterline.

4.2.1.8^A Slip Resistant POOL floors in areas less than 3 feet (0.9 m) deep shall have a SLIP-RESISTANT finish.

4.2.1.9 Stainless Steel, Vinyl, PVC-P or PVC Pools Stainless steel, vinyl, PVC-P, or PVC panel and liner POOL finish systems shall be acceptable provided that the system is installed on top of approved materials and design requirements as listed within this section.

4.2.1.9.1 Damaged If at any time the liner system is damaged or cut in such a way that its integrity is compromised, the POOL shall be shut down until the system is fully repaired.

4.2.1.10 Not Permitted Wood, sand, or earth shall not be permitted as an interior finish.

4.2.2 Indoor Aquatic Facility

4.2.2.1 Interior Finish

4.2.2.1.1 Relative Humidity The interior finish of an INDOOR AQUATIC FACILITY shall be designed for an indoor relative humidity as not less than 80%.

4.2.2.2^A Condensation Prevention

4.2.2.2.1^A Cold Weather INDOOR AQUATIC FACILITY building envelope construction shall include a vapor-retarder/insulation arrangement to assist in preventing the condensation of water on inside POOL room envelope building surfaces and within any wall, ceiling, glass, or floor structure under the coldest outdoor conditions based on the ASHRAE climate data for the project locale or nearest reporting city and the highest design indoor relative humidity.

4.2.2.2.1.1 Weather Data The ASHRAE dehumidification weather data for the facility geographical location shall be used when calculating the effects of the ventilation air to the space it is being introduced. This shall be added to the evaporation load of all water surfaces, and occupant (includes spectators, swimmers, and non-swimmers on the DECK) latent moisture when sizing the climate control equipment.

4.2.2.2.2^A Paint or Coating Where a paint or coating serves as the vapor retarder of an INDOOR AQUATIC FACILITY, the paint or coating shall be applied so as to produce a permeability rating of 0.2 U.S. perm ($11.4 \text{ ng}\cdot\text{s}^{-1}\cdot\text{m}^{-2}\cdot\text{Pa}^{-1}$) or less. All paints and coatings applied inside the air barrier of a facility shall meet the requirements of UL 2818-2013 through testing of products to CDPH/EHLB/Standard Method v1.1 or UL 2818-2013.

4.2.2.2.2.1 Application The paint or coating shall be applied according to the manufacturer's recommendations for use as a vapor retarder.

4.2.2.2.3 Perforated Interior-Finish Material Where a perforated interior-finish material is used in an INDOOR AQUATIC FACILITY, as for acoustic effects, the perforated material shall not be considered to be a vapor retarder unless it has a listed permeability rating less than 0.2 U.S. perm ($11.4 \text{ ng}\cdot\text{s}^{-1}\cdot\text{m}^{-2}\cdot\text{Pa}^{-1}$).

4.2.2.3 Mechanical Systems

4.2.2.3.1 Equipment Rooms For EQUIPMENT ROOMS, see MAHC 4.9.1.

4.2.2.3.2 Chemical Storage Spaces For chemical storage spaces, see MAHC 4.9.2.

4.2.2.3.3^A Indoor Aquatic Facility Air Pressure INDOOR AQUATIC FACILITY air pressure shall be relative to the areas external to it (such as adjacent indoor spaces or adjacent outdoor spaces.) The AQUATIC FACILITY AIR HANDLING SYSTEM design, construction, and installation shall comply with the ASHRAE 2019 negative pressure recommendations as outlined in the ASHRAE Applications Handbook on Indoor Pool Design and the ASHRAE Standard 62.1, *Ventilation for Acceptable Indoor Air Quality*, and all applicable local, state, territorial, federal, and tribal laws and additional requirements as stated in section MAHC 4.6.2.

4.2.2.3.3.1 Chemical Storage Space Air Pressure AIR HANDLING SYSTEM design for CHEMICAL STORAGE SPACES shall conform to the International Mechanical Code or Uniform Mechanical Code, and either the International Fire Code or the NFPA 1 Fire Code, and all applicable local, state, territorial, federal, and tribal laws.

4.2.2.3.3.1.1 Not Interconnected This CHEMICAL STORAGE SPACE AIR HANDLING SYSTEM shall not be interconnected with the INDOOR AQUATIC FACILITY'S CLIMATE CONTROL SYSTEM.

4.2.2.3.4^A Air Ducts Where air ducts are required, they shall be resistant to corrosion from the airborne chemicals.

4.2.2.3.4.1^A **Insulated Duct** Any system duct work located in an area not being conditioned shall be insulated on the exterior of the duct with a mold-resistant material where the surface temperature of the duct is capable of being less than the airstream temperature within the duct.

4.2.2.3.5 **Filters** Filters for outdoor-air intake shall be rated moisture resistant.

4.2.2.4^A Indoor Aquatic Facility Doors

4.2.2.4.1 **Corrosion Resistant** INDOOR AQUATIC FACILITY doors shall either be constructed of corrosion-resistant materials or have a covering or coating to withstand humid and corrosive environments which is acceptable to the AHJ.

4.2.2.4.2 **Uncontrolled Condensation** INDOOR AQUATIC FACILITY doors which may be exposed to temperatures below INDOOR AQUATIC FACILITY-air dew point shall have thermal breaks, insulation, and/or glazing as necessary to minimize the risk of uncontrolled condensation.

4.2.2.4.2.1 **Heating Systems Exception:** Other doors shall be acceptable, subject to approval by the AHJ, where heating systems are so arranged as to maintain such doors above the maximum design dew point of the INDOOR AQUATIC FACILITY air.

4.2.2.4.3 **Biological Contaminants** INDOOR AQUATIC FACILITY doors and door-frame construction shall not contribute to the growth of biological CONTAMINANTS.

4.2.2.4.4 **Air Leakage** INDOOR AQUATIC FACILITY doors and/or door frames shall be equipped with seals and/or gaskets to minimize air leakage when the door is closed.

4.2.2.4.5^A **Automatic Door Closer** All pedestrian doors around the INDOOR AQUATIC FACILITY perimeter shall be equipped with an automatic door closer capable of closing the door completely without human assistance and a self-latching device designed to engage and keep the door closed without human assistance.

4.2.2.4.5.1 **Difference in Air Pressure** Door closers shall be able to close the door against the specified difference in air pressure between the INDOOR AQUATIC FACILITY and other INTERIOR SPACES.

4.2.2.5^A Indoor Aquatic Facility Windows

4.2.2.5.1 **Frames** INDOOR AQUATIC FACILITY window frames shall be constructed of suitable materials or shall have a suitable covering or coating to withstand the expected atmosphere.

4.2.2.5.2 **Biological Contaminants** INDOOR AQUATIC FACILITY window frames shall be constructed of materials that do not contribute to the growth of biological CONTAMINANTS.

4.2.2.5.3 **Thermal Breaks** INDOOR AQUATIC FACILITY window frames shall have thermal breaks or be otherwise constructed to minimize the risk of uncontrolled condensation.

4.2.2.6 **Indoor Aquatic Facility Electrical Systems and Components** Refer to MAHC 4.6.3

4.3 Equipment Standards

4.3.1 **Accredited Standards** Where applicable, all equipment used or proposed for use in AQUATIC FACILITIES governed under this CODE shall be:

- 1) Of a proven design and construction and
- 2) CERTIFIED, LISTED, AND LABELED to a specific STANDARD for the specified equipment use by an ANSI-accredited certification organization.

4.3.2 **No Standards** Where STANDARDS do not exist, technical documentation shall be submitted to the AHJ to demonstrate acceptability for use in AQUATIC FACILITIES.

4.3.3 **Suitable for Intent** All equipment and materials used or proposed for use in AQUATIC FACILITIES shall be suitable for their intended use and be installed in accordance with this CODE, as CERTIFIED, LISTED, AND

LABELED to a specific STANDARD by an ANSI-accredited certification organization where applicable, and as specified by the manufacturer.

4.3.3.1 Proof of Acceptability The AHJ shall have the authority to require tests, as proof of acceptability.

4.4 Aquatic Facility and Venue Operation and Maintenance [N/A]

4.5 Aquatic Venue Structure

4.5.1^A Design for Risk Management Design of AQUATIC FACILITIES and/or AQUATIC VENUE(s) shall include consultation with and input by the owner and/or an aquatic risk management consultant and address operational considerations such as the layout of zones of PATRON surveillance.

4.5.1.1 Basic Requirements The AQUATIC VENUE shape shall provide for the SAFETY of swimmers, the thorough and complete circulation of the water, the ability to clean and maintain the AQUATIC VENUE, and be considered when planning for effective supervision and surveillance of BATHERS and PATRONS using the AQUATIC VENUE.

4.5.1.2 Water Clarity Main suction outlets or a permanent tile used as a reference to test for or observe water clarity shall be installed according to MAHC 4.5.1.2.1 through 4.5.1.2.4.

4.5.1.2.1 Pools Ten Feet Deep or Less For POOLS 10 feet deep (3.0 m) or less, a 4 inch x 4 inch square (10.2 cm x 10.2 cm) reference tile in a contrasting color to the POOL floor or main suction outlet shall be located at the deepest part of the POOL.

4.5.1.2.2 Pools Over Ten Feet Deep For POOLS over 10 feet deep (3.0 m) an 8 inch by 8 inch square (20.3 cm x 20.3 cm) reference tile in a contrasting color to the POOL floor or main suction outlet shall be located at the deepest part of the POOL.

4.5.1.2.3 Visible This reference tile shall be visible at all times at any point on the DECK up to 30 feet (9.1 m) away in a direct line of sight from the tile or main drain.

4.5.1.2.4 Spas For SPAS, this test shall be performed when the water is in a non-turbulent state and bubbles have been allowed to dissipate.

4.5.1.2.5 Reference Tile Alternative Where main suction outlets are not provided for or where finish materials do not allow for the installation of a water clarity reference tile, an alternate means of achieving the goal of observing water clarity shall be provided.

4.5.2 Bottom Slope

4.5.2.1^A Under Five Feet In water depths under 5 feet (1.5 m), the slope of the floor of all POOLS shall not exceed 1 foot (30.5 cm) vertical drop for every 12 feet (3.7 m) horizontal.

4.5.2.2 Five Feet or Over In water depths 5 foot (1.5 m) and greater, the slope of the floors of all POOLS shall not exceed 1 foot (30.5 cm) vertical to 3 feet (0.9 m) horizontal. **Exception:** POOLS designed and used for competitive diving shall be designed to meet the STANDARDS of the sanctioning organization (such as NFHS, NCAA, USA Diving, or FINA).

4.5.2.3^A Drain POOLS shall be designed so that they drain without leaving puddles or trapped standing water.

4.5.3 Pool Access / Egress

4.5.3.1^A Accessibility Each POOL shall have a minimum of two means of access and egress, with one located within 10 feet (3.0 m) of the shallowest end, and one located within 10 feet of the deepest end of the POOL, where applicable, with the exception of:

- 1) Waterslide landing pools,

- 2) Waterslide runouts, and
- 3) Wave pools.

4.5.3.2 Acceptable Means Acceptable means of access / egress shall include stairs / handrails, grab rails / RECESSED STEPS, ladders, ramps, and zero-depth entries.

4.5.3.3 Large Venues For POOLS wider than 30 feet (9.1 m), such means of access / egress shall be provided on each side of the POOL.

4.5.3.3.1 Distance Apart For POOLS wider than 30 feet (9.1 m), such means of access / egress shall not be more than 75 feet (22.9 m) apart.

4.5.4 Stairs

4.5.4.1 Slip Resistant Where provided, stairs shall be constructed with SLIP-RESISTANT materials.

4.5.4.2 Outlined Edges The leading horizontal and vertical edges of stair treads shall be outlined with a continuous SLIP-RESISTANT, contrasting tile or other permanent marking of not less than 1 inch (25.4 mm) and not greater than 2 inches (50.8 mm).

4.5.4.3^A Deep Water Where stairs are provided in POOL water depths greater than 5 feet (1.5 m), they shall be recessed and not protrude into the swimming area of the POOL.

4.5.4.3.1 Lowest Tread Where stairs are provided in POOL water depths greater than 5 feet (1.5 m), the lowest tread shall be not less than 4 feet (1.2 m) below normal water elevation.

4.5.4.4 Stairs Stairs shall have a minimum uniform horizontal tread depth of 12 inches (30.5 cm), and a minimum unobstructed tread width of 24 inches (61.0 cm).

4.5.4.5 Dimensions Dimensions of stair treads for other types of stairs shall conform to requirements of:

- 1) MAHC Table 4.5.4.5,
- 2) MAHC Figure 4.5.4.5.1, and
- 3) MAHC Figure 4.5.4.5.2

Table 4.5.4.5: Required Dimensions for Stair Treads and Risers

Dimensions	T-1 Standard	T-2	W-1	H-1
Minimum	12 inches (30.5 cm)	T-1	24 inches (61.0 cm)	6 inches (15.2 cm)
Maximum	18 inches (45.7 cm)	T-1	N/A	12 inches (30.5 cm)

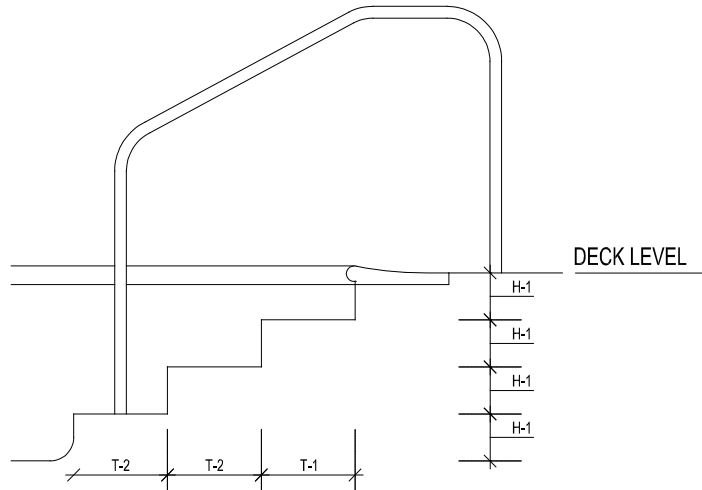
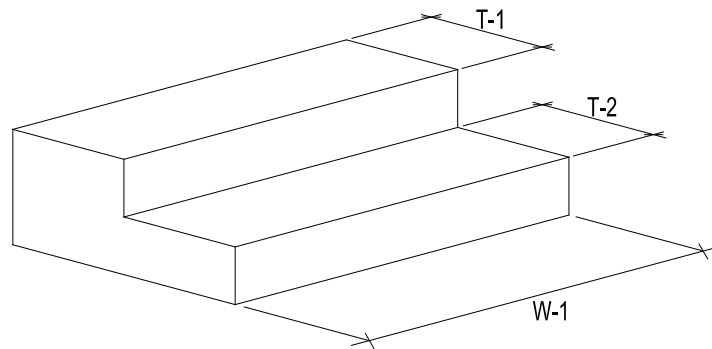
Figure 4.5.4.5.1: Stair Treads and Risers: Side View**Figure 4.5.4.5.2: Stair Treads: Front View**

4.5.4.6 Stair Risers Stair risers shall have a minimum uniform height of 6 inches (15.2 cm) and a maximum height of 12 inches (30.5 cm), with a tolerance of ½ inches (12.7 mm) between adjacent risers.

4.5.4.6.1 Transitional Areas Stairs shall not be used underwater to transition between two sections of POOL of different depths. The bottom riser may vary due to potential cross slopes with the POOL floor; however, the bottom step riser may not exceed the maximum allowable height required by this section.

4.5.4.7 Top Surface The top surface of the uppermost stair tread shall be located not more than 12 inches (30.5 cm) below the POOL coping or DECK.

4.5.4.8^A Perimeter Gutter Systems For POOLS with PERIMETER GUTTER SYSTEMS, the gutter may serve as a step, provided that the gutter is provided with a grating or cover and conforms to all construction and dimensional requirements herein specified.

4.5.5 Handrails

4.5.5.1 Provided Handrail(s) shall be provided for each set of stairs.

4.5.5.2 Corrosion Resistant Handrails shall be constructed of corrosion-resistant materials and anchored securely.

4.5.5.3^A Upper Railing The upper railing surface of handrails shall extend above the POOL coping or DECK a minimum of 28 inches (71.1 cm).

4.5.5.4 Wider Than Five Feet Stairs wider than 5 feet (1.5 m) shall have handrails at either side and

spaced not more than every 12 feet (3.7 m) apart across the entire stair width.

4.5.5.5^A ADAAG Accessibility Handrail outside dimensions intended to serve as a means of ADAAG accessibility shall conform to requirements of MAHC 4.5.5.6.

4.5.5.6 Support Handrails shall be designed to resist a load of 50 pounds (22.7 kg) per linear foot applied in any direction and independently a single concentrated load of 200 pounds (90.7 kg) applied in any direction at any location.

4.5.5.6.1 Transfer Loads Handrails shall be designed to transfer these loads through the supports to the POOL or DECK structure.

4.5.5.7^A Dimensions Dimensions of handrails shall conform to requirements of MAHC Table 4.5.5.7 and MAHC Figure 4.5.5.7.1.

Table 4.5.5.7: Stair Handrail Dimensions

Dimensions	T-1	H-1
Minimum	3 inches (7.6 cm)	34 inches (86.4 cm)
Maximum	N/A	38 inches (96.5 cm)

Figure 4.5.5.7.1: Stair Handrails: Side View

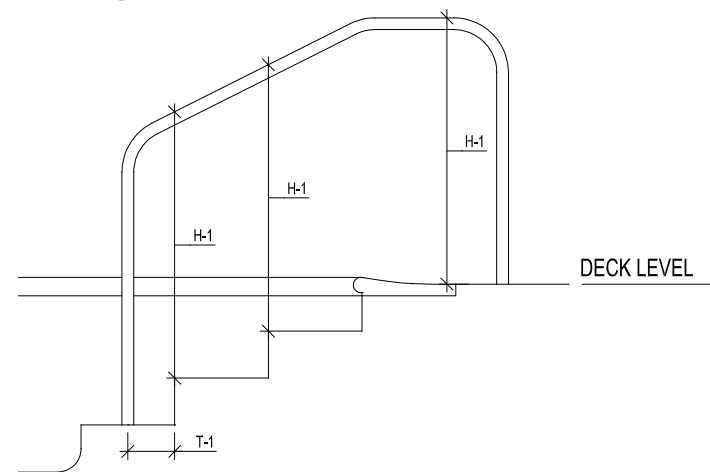

4.5.6 Grab Rails

4.5.6.1 Corrosion Resistant Where grab rails are provided, they shall be constructed of corrosion-resistant materials.

4.5.6.2 Anchored Grab rails shall be anchored securely.

4.5.6.3 Provided Grab rails shall be provided at both sides of RECESSED STEPS.

4.5.6.4 Clear Space The horizontal clear space between grab rails shall be not less than 18 inches (45.7 cm) and not more than 24 inches (61.0 cm).

4.5.6.5 Upper Railing The upper railing surface of grab rails shall extend above the POOL coping or DECK a minimum of 28 inches (71.1 cm).

4.5.6.6 Support Grab rails shall be designed to resist a load of 50 pounds (22.7 kg) per linear foot applied in any direction and independently a single concentrated load of 200 pounds (90.7 kg) applied in any

direction at any location.

4.5.6.6.1 Transfer Loads Grab rails shall be designed to transfer these loads through the supports to the POOL or DECK structure.

4.5.7 Recessed Steps

4.5.7.1 Slip Resistant Recessed steps shall be SLIP RESISTANT.

4.5.7.2 Easily Cleaned RECESSED STEPS shall be designed to be easily cleaned.

4.5.7.3 Drain RECESSED STEPS shall drain into the POOL.

4.5.7.4 Dimensions Dimensions of RECESSED STEPS shall conform to requirements of:

- 1) MAHC Table 4.5.7.4,
- 2) MAHC Figure 4.5.7.4.1, and
- 3) MAHC Figure 4.5.7.4.2.

Table 4.5.7.4: Recessed Step Dimensions

Dimensions	H-1	H-2	W-1	D-1	D-2
Minimum	6 inches (15.2 cm)	5 inches (12.7 cm)	12 inches (30.5 cm)	5 inches (12.7 cm)	N/A
Maximum	12 inches (30.5 cm)	N/A	N/A	N/A	2.5 inches (6.5 cm)

Figure 4.5.7.4.1: Recessed Step Dimensions: Side View

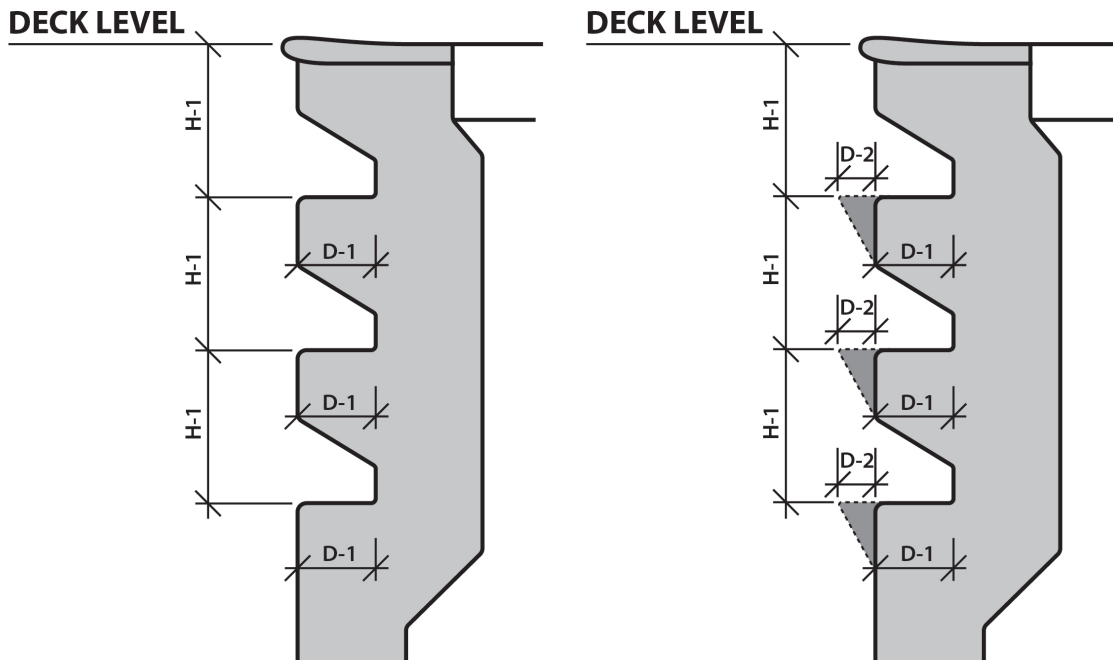
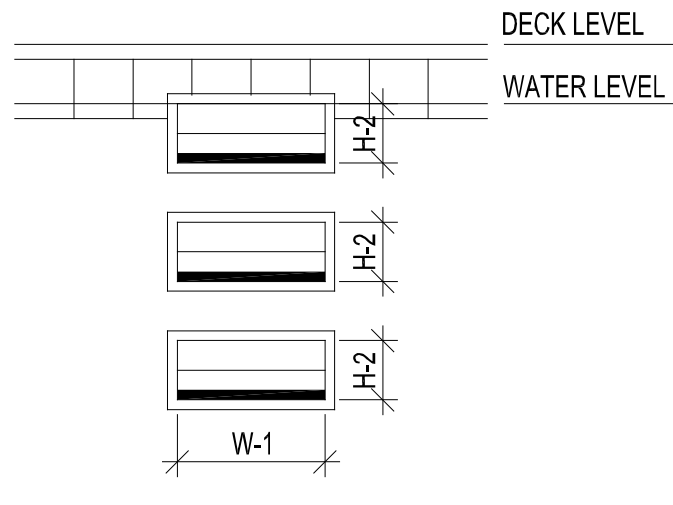

Figure 4.5.7.4.2: Recessed Step Dimensions: Front View

4.5.7.5 Uniformly Spaced RECESSED STEPS shall be uniformly spaced not less than 6 inches (15.2 cm) and not more than 12 inches (30.5 cm) vertically along the POOL wall.

4.5.7.6 Uppermost Step The top surface of the uppermost RECESSED STEP shall be located not more than 12 inches (30.5 cm) below the POOL coping or DECK.

4.5.7.7 Perimeter Gutter Systems For POOLS with PERIMETER GUTTER SYSTEMS, the gutter may serve as a step, provided that the gutter is provided with a grating or cover and conforms to all construction and dimensional requirements herein specified.

4.5.8 Ladders

4.5.8.1 General Guidance for Ladders

4.5.8.1.1 Corrosion Resistant Where provided, ladders shall be constructed of corrosion-resistant materials.

4.5.8.1.2 Anchored Ladders shall be anchored securely to the DECK.

4.5.8.2^A Ladder Handrails

4.5.8.2.1 Two Handrails Provided Ladders shall have two handrails.

4.5.8.2.2 Clear Space The horizontal clear space between handrails shall be not less than 17 inches (43.2 cm) and not more than 24 inches (61.0 cm).

4.5.8.2.3 Upper Railing The upper railing surface of handrails shall extend above the POOL coping or DECK a minimum of 28 inches (71.7 cm).

4.5.8.2.4^A Pool Wall The clear space between handrails and the POOL wall shall be not less than 3 inches (7.6 cm) and not more than 4 inches (10.2 cm) between the POOL wall and the ladder.

4.5.8.2.5^A Support Ladders shall be designed to resist a load of 50 pounds (22.7 kg) per linear foot applied in any direction and independently a single concentrated load of 200 pounds (90.7 kg) applied in any direction at any location.

4.5.8.2.5.1 Transfer Loads Ladders shall be designed to transfer these loads through the supports to the POOL or DECK structure.

4.5.8.3 Ladder Treads

4.5.8.3.1 Slip Resistant Ladder treads shall be SLIP RESISTANT.

4.5.8.3.2 Tread Depth Ladder treads shall have a minimum horizontal tread depth of 1.5 inches

(3.8 cm).

4.5.8.3.2.1 Distance Between Tread and Pool Wall The distance between the horizontal tread and the POOL wall shall not be greater than 4 inches (10.2 cm).

4.5.8.3.3 Uniformly Spaced Ladder treads shall be uniformly spaced not less than 7 inches (17.8 cm) and not more than 12 inches (30.5 cm) vertically at the handrails.

4.5.8.3.4 Upmost Ladder Tread The top surface of the upmost ladder tread shall be located not more than 12 inches (30.5 cm) below the POOL coping, gutter, or DECK.

4.5.9 Zero Depth (Sloped) Entries

4.5.9.1 Slip Resistant Where ZERO DEPTH ENTRIES are provided, they shall be constructed with SLIP-RESISTANT materials.

4.5.9.2 Maximum Floor Slope ZERO DEPTH ENTRIES shall have a maximum floor slope of 1:12, consistent with the requirements of MAHC 4.5.2.1.

4.5.9.2.1 Slope Changes Changes in floor slope shall be permitted.

4.5.9.3 Trench Drains Trench drains shall be used along ZERO DEPTH ENTRIES at the waterline to facilitate surface skimming.

4.5.9.3.1 Flat or Follow Slope The trenches may be flat or follow the slope of the ZERO DEPTH ENTRY.

4.5.9.3.2 Handholds Any handholds that present a trip hazard shall not be continuous along the ZERO DEPTH ENTRY.

4.5.9.4 Rope and Float Line Where the bottom of a POOL slopes from a ZERO DEPTH ENTRY to water depths greater than 3 feet (0.9 m) and includes an area for young non-swimmers to wade and play, a ROPE AND FLOAT LINE shall be installed at the 3 feet (0.9 m) depth to provide a visual and physical separation between the area for toddlers and young non-swimmers and the deeper areas of the POOL.

4.5.9.4.1 Exceptions An exception shall be made for WAVE POOLS, SURF POOLS, and WATERSLIDE LANDING POOLS.

4.5.10 Disabled Access

4.5.10.1^A Conform to ADA Standards Access for disabled persons shall conform to ADA STANDARDS as approved by the Department of Justice.

4.5.10.2 Pool Lifts All POOL lifts shall be CERTIFIED, LISTED, AND LABELED in accordance with UL 60335-2-1000, and be installed and used in accordance with the manufacturer's installation instructions and ICC/ANSI A117.1.

4.5.11 Color and Finish

4.5.11.1^A White or Light Pastel Floors and walls below the water line shall be white or light pastel in color such that from the POOL DECK a BATHER is visible on the POOL floor and the following items can be identified:

- 1) Algae growth, debris, or dirt within the POOL;
- 2) CRACKS in the surface finish of the POOL; and
- 3) Reference tiles defined in MAHC 4.5.1.2.

4.5.11.1.1^A Munsell Color Value The finish shall be at least 6.5 on the Munsell color value scale.

4.5.11.1.2 Exceptions An exception shall be made for the following AQUATIC VENUE components:

- 1) Competitive lane markings,
- 2) Dedicated competitive diving well floors,
- 3) Step or bench edge markings,
- 4) POOLS shallower than 24 inches (61.0 cm),
- 5) Water line tiles, or
- 6) WAVE POOL and SURF POOL depth change indicator tiles.

4.5.12 Walls

4.5.12.1 Plumb POOL walls shall be plumb within a +/- 3 degree tolerance to a water depth of at least 5 feet (1.5 m) unless the wall design requires structural support ledges and slopes below to support the upper wall. Refer to MAHC Figure 4.5.12.1.

Figure 4.5.12.1: Plumb Pool Walls: Cross-Section

Plumb within a +/- 3 degree tolerance.

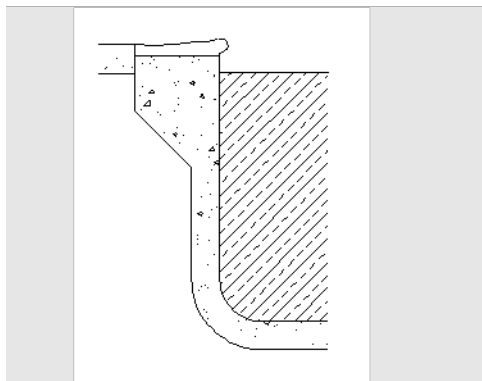

4.5.12.2 Contrasting Color A contrasting color shall be provided on the edges of any support ledge to draw attention to the ledge for BATHER SAFETY.

4.5.12.3 Rounded Corners All corners created by adjoining walls shall be rounded or have a radius in both the vertical and horizontal dimensions to eliminate sharp corners.

4.5.12.4^A No Protrusions, Extensions, Means of Entanglement, or Obstructions There shall be no protrusions, extension, means of entanglement, or other obstructions in the AQUATIC VENUE that may cause the entrapment or injury of the user or interfere with proper POOL operation.

4.5.12.5 Transitional Point Where walls join the floor, the transitional point or profile shall comply with the following:

4.5.12.5.1 Intersect Walls may intersect with the floor at an angle or a transition profile.

4.5.12.5.2 Depths 3–5 Feet At water depths 3–5 ft (91–152 cm), the maximum radius shall be 2 ft 3 in (69 cm).

4.5.12.5.3 Depths Less Than Three Feet At water depths 3 ft (91 cm) or less, a transitional radius shall not exceed 6 in (15 cm) and shall be tangent to the wall and may be tangent to or intersecting the floor.

4.5.12.5.4 Depths Greater Than Three Feet At water depths greater than 3 ft (91 cm), a transitional radius shall be tangent to the wall at a point no less than 2 ft 6 in (76 cm) below the water surface and may progressively increase from 6 in (15 cm) to a value capable of being tangent to or intersecting the floor.

4.5.13^A Structural Stability

4.5.13.1 Withstand Loads POOLS shall be designed to withstand the reasonably anticipated loads imposed by POOL water, BATHERS, and adjacent soils or structures.

4.5.13.2 Hydrostatic Relief Valve A hydrostatic relief valve and/or suitable under drain system shall be provided where the water table exerts hydrostatic pressure to uplift the POOL when empty or drained.

4.5.13.3 Freezing POOLS and related circulation piping shall be designed with a winterizing strategy when in an area subject to freeze/thaw cycles.

4.5.14^A Handholds

4.5.14.1 Handholds Provided Where not otherwise exempted, every POOL shall be provided with handholds (*PERIMETER GUTTER SYSTEM, coping, horizontal bars, recessed handholds, cantilevered DECKING*) around the perimeter of the POOL where the water depth at the wall exceeds 24 inches (*61.0 cm*).

4.5.14.1.1 Installed These handholds shall be installed not greater than 9 inches (*22.9 cm*) above, or 3 inches (*7.6 cm*) below static water level.

4.5.14.2 Horizontal Recesses Horizontal recesses may be used for handholds provided they are a minimum of 24 inches (*61.0 cm*) long, a minimum of 4 inches (*10.2 cm*) high and between 2 inches (*5.1 cm*) and 3 inches (*7.6 cm*) deep.

4.5.14.2.1 Drain Horizontal recesses shall drain into the POOL.

4.5.14.2.2 Consecutive Recesses Horizontal recesses need not be continuous, but consecutive recesses shall be separated by no more than 12 inches (*30.5 cm*) of wall.

4.5.14.3 Decking Where PERIMETER GUTTER SYSTEMS are not provided, a coping or cantilevered DECKING of reinforced concrete or material equivalent in strength and durability, with rounded, SLIP-RESISTANT edges shall be provided.

4.5.14.4 Coping Dimensions The horizontal overhang for coping or cantilevered DECKING shall not be greater than 2 inches (*5.1 cm*) from the vertical plane of the POOL wall, nor less than 1 inch (*2.5 cm*).

4.5.14.5 Coping Thickness The vertical thickness of the coping or cantilevered DECKING shall not exceed 2.5 inches (*6.4 cm*) for the horizontal overhang.

4.5.15 Infinity Edges

4.5.15.1^A Perimeter Restrictions Not more than fifty percent (*50%*) of the POOL perimeter shall incorporate an INFINITY EDGE detail, unless an adjacent and PATRON accessible DECK space conforming to MAHC 4.8.1 is provided.

4.5.15.2 Length The length of an INFINITY EDGE shall be no more than 30 feet (*9.1 m*) long when in water depths greater than 5 feet (*1.5 m*).

4.5.15.2.1 Shallow Water No maximum distance is enforced for the length of INFINITY EDGES in shallow water 5 feet (*1.5 m*) and less.

4.5.15.3^A Handholds Handholds conforming to the requirements of MAHC 4.5.14 shall be provided for INFINITY EDGES, which may be separate from, or incorporated as part of the INFINITY EDGE detail.

4.5.15.4 Construction Guidance Where INFINITY EDGES are provided, they shall be constructed of reinforced concrete or other impervious and structurally rigid material(s) and designed to withstand the loads imposed by POOL water, BATHERS, and adjacent soils or structures.

4.5.15.5 Overflow Basins Troughs, basins, or capture drains designed to receive the overflow from

INFINITY EDGES shall be watertight and free from STRUCTURAL CRACKS.

4.5.15.5.1 *Finish* Troughs, basins, or capture drains designed to receive the overflow from INFINITY EDGES shall have a non-toxic, smooth, and SLIP-RESISTANT finish.

4.5.15.6^A **Maximum Height** The maximum height of the wall outside of the INFINITY EDGE shall not exceed 30 inches (76.2 cm) to the adjacent grade and capture drain.

4.5.16^A **Underwater Benches**

4.5.16.1^A **Slip Resistant** Where provided, UNDERWATER BENCHES shall be constructed with SLIP-RESISTANT materials.

4.5.16.2 **Outlined Edges** The leading horizontal and vertical edges of UNDERWATER BENCHES shall be outlined with a continuous slip-resistant, color-contrasting tile or other permanent marking of not less than $\frac{3}{4}$ inch (1.9 cm) and not greater than 2 inches (5.1 cm).

4.5.16.3^A **Maximum Water Depth** UNDERWATER BENCHES may be installed in areas of varying depths, but the maximum POOL water depth in that area shall not exceed 5 feet (1.5 m).

4.5.16.4 **Maximum Seat Depth** The maximum submerged depth of any seat or sitting bench shall be 20 inches (50.8 cm) measured from the water line.

4.5.17 **Underwater Ledges**

4.5.17.1^A **Slip Resistant** Where UNDERWATER TOE LEDGES are provided to enable swimmers to rest or to provide structural support for an upper wall, they shall be constructed with SLIP-RESISTANT materials.

4.5.17.2 **Protrude** UNDERWATER TOE LEDGES for resting that are recessed or protrude beyond the vertical plane of the POOL wall shall meet the criteria for SLIP RESISTANT and tread depth outlined in this section.

4.5.17.3^A **Five Feet or Greater** UNDERWATER TOE LEDGES for resting shall only be provided within areas of a POOL with water depths of 5 feet (1.5 m) or greater.

4.5.17.3.1 *Underwater Toe Ledge* UNDERWATER TOE LEDGES shall start no earlier than 4 lineal feet (1.2 m) to the deep side of the 5 foot (1.5 m) slope break.

4.5.17.3.2 *Below Water Level* UNDERWATER TOE LEDGES shall be at least 4 feet (1.2 m) below static water level.

4.5.17.4^A **Structural Support** UNDERWATER LEDGES for structural support of upper walls shall be allowed.

Figure 4.5.17.4: Structural Support Ledges

(A) Structural support ledge all within
1 in 5 slope.

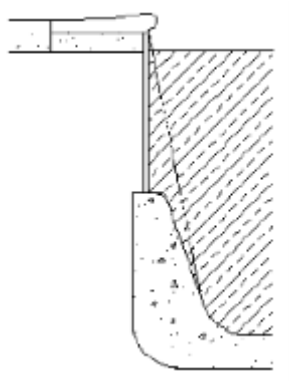

(B) Underwater ledge for support of upper wall.

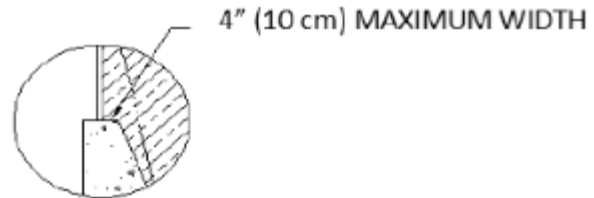

4.5.17.4.1 Ledge Slope All structural support ledges and slopes of the wall below shall fall within a plane sloped at a maximum of 1 horizontally in 5 vertically or 11 degrees from the water line down to a water depth of 5 feet (1.5 m). Refer to MAHC Figure 4.5.17.4.

4.5.17.4.2 Ledge Depth A structural support ledge shall be installed at a water depth of 3 feet (0.9 m) or deeper.

4.5.17.5 Outlined The edges of UNDERWATER TOE LEDGES and underwater structural support ledges shall be outlined with a continuous SLIP-RESISTANT, color-contrasting tile or other permanent marking of not less than 1 inch (2.5 cm) and not greater than 2 inches (5.1 cm).

4.5.17.5.1 Visible If they project past the plane of the POOL wall, the edges of UNDERWATER TOE LEDGES and underwater structural support ledges shall be clearly visible from the DECK.

4.5.17.6 Tread Depths UNDERWATER TOE LEDGES and underwater structural support ledges shall have a maximum uniform horizontal tread depth of 4 inches (10.2 cm). See MAHC Figure 4.5.17.4.

4.5.18^A Underwater Shelves

4.5.18.1 Immediately Adjacent UNDERWATER SHELVES may be constructed immediately adjacent to water 3 feet 6 inches (1.1 m) or shallower.

4.5.18.2 Nosing UNDERWATER SHELVES shall have a SLIP-RESISTANT, color-contrasting nosing at the leading horizontal and vertical edges on both the top of horizontal edges and leading vertical edges and should be clearly visible from the DECK or from underwater.

4.5.18.3 Maximum Depth UNDERWATER SHELVES shall have a maximum depth of 24 inches (61.0 cm).

4.5.18.4 Depth Markings Depth markings required at the same spacing as required by MAHC 4.5.19 and are in addition to the depth marking locations on the deck as required by MAHC 4.5.19.

4.5.19 Depth Markers and Markings

4.5.19.1 Location

4.5.19.1.1 Markings POOL water depths shall be clearly and permanently marked at the following locations:

- 1) Minimum depth,
- 2) Maximum depth,
- 3) On both sides and at each end of the POOL, and
- 4) At the break in the floor slope between the shallow and deep portions of the POOL.

4.5.19.1.2^A **Depth Measurements** Depth markers shall be located on the vertical POOL wall and positioned to be read from within the POOL.

4.5.19.1.3^A **Below Handhold** Where depth markings cannot be placed on the vertical wall above the water level, other means shall be used so that the markings will be plainly visible to persons in the POOL.

4.5.19.1.4 **Coping or Deck** Depth markers shall also be located on the POOL coping or DECK within 18 inches (45.7 cm) of the POOL structural wall or perimeter gutter.

4.5.19.1.5 **Read on Deck** Depth markers shall be positioned to be read while standing on the DECK facing the POOL.

4.5.19.1.6 **Twenty-Five Foot Intervals** Depth markers shall be installed at not more than 25 (7.6 m)-foot intervals around the POOL perimeter edge and according to the requirements of this section.

4.5.19.1.6.1 **Five Feet or Less** For water less than 5 feet (1.5 m) in depth, the depth shall be marked at 1 foot (30.5 cm) depth intervals.

4.5.19.2 **Construction / Size**

4.5.19.2.1 **Durable** Depth markers shall be constructed of a durable material resistant to local weather conditions.

4.5.19.2.2 **Slip Resistant** Depth markers shall be SLIP RESISTANT when they are located on horizontal surfaces.

4.5.19.2.3^A **Color and Height** Depth markers shall have letters and numbers with a minimum height of 4 inches (10.2 cm) of a color contrasting with background.

4.5.19.2.4^A **Feet and Inches** Depth markers shall be marked in units of feet and inches.

4.5.19.2.4.1 **Abbreviations** Abbreviations of “FT” and “IN” may be used in lieu of “FEET” and “INCHES.”

4.5.19.2.4.1.1 **Abbreviations** Symbols for feet (′) and inches (″) shall not be permitted on water depth signs.

4.5.19.2.4.2 **Metric** Metric units may be provided in addition to—but not in lieu of—units of feet and inches.

4.5.19.3 **Tolerance** Depth markers shall be located to indicate water depth to the nearest 3 inches (7.6 cm), as measured from the POOL floor 3 feet (0.9 m) out from the POOL wall to the gutter lip, mid-point of surface SKIMMER(S), or surge weir(s).

4.5.19.4 **No Diving Markers**

4.5.19.4.1^A **Depths** For POOL water depths 5 feet (1.5 m) or shallower, all DECK depth markers required by MAHC 4.5.19 shall be provided with “NO DIVING” warning signs along with the universal international symbol for “NO DIVING.”

4.5.19.4.1.1 **Spacing** “NO DIVING” warning signs and symbols shall be spaced at no more than 25 foot (7.6 m) intervals around the POOL perimeter edge.

4.5.19.4.2 **Durable** “NO DIVING” MARKERS shall be constructed of a durable material resistant to local weather conditions.

4.5.19.4.3 **Slip Resistant** “NO DIVING” MARKERS shall be SLIP RESISTANT when they are located on horizontal surfaces.

4.5.19.4.4 **At Least Four Inches** All lettering and symbols shall be at least 4 inches (10.2 cm) in height.

4.5.19.5^A Depth Marking At Break in Floor Slope

4.5.19.5.1 **Over Five Feet** For POOLS deeper than 5 feet (1.5 m), a line of contrasting color, not less than 2 inches (5.1 cm) and not more than 6 inches (15.2 cm) in width, shall be clearly and permanently installed on the POOL floor at the shallow side of the break in the floor slope, and extend up the POOL walls to the waterline.

4.5.19.5.2 **Durable** Depth marking at break in floor slope shall be constructed of a durable material resistant to local weather conditions and be SLIP RESISTANT.

4.5.19.5.3 **Rope and Float Line** One foot (30.5 cm) to the shallower side of the break in floor slope and contrasting band, a ROPE AND FLOAT LINE shall extend across the POOL surface with the exception of WAVE POOLS, SURF POOLS, and WATERSLIDE LANDING POOLS.

4.5.19.6^A Dual Marking System Symmetrical AQUATIC VENUE designs with the deep point at the center may be allowed by providing a dual depth marking system which indicates the depth at the wall as measured in MAHC 4.5.19.3 and at the deep point.

4.5.19.7 Non-Traditional Aquatic Venues Controlled-access AQUATIC VENUES (such as ACTIVITY POOLS, LAZY RIVERS, and other AQUATIC VENUES with limited access) shall only require depth markers on a sign at points of entry.

4.5.19.7.1 **Clearly Visible** Depth marker signs shall be clearly visible to PATRONS entering the VENUE.

4.5.19.7.2 **Lettering and Symbols** All lettering and symbols shall be as required for other types of depth markers.

4.5.19.8^A Wading Pool Depth Markers AQUATIC VENUES where the maximum water depth is 6 inches (15.2 cm) of water or less (such as WADING POOLS and ACTIVITY POOL areas) shall not be required to have depth markings or “NO DIVING” signage.

4.5.19.9 Movable Floor Depth Markers For AQUATIC VENUES with movable floors, a sign indicating movable floor and/or varied water depth shall be provided and clearly visible from the DECK.

4.5.19.9.1 **Vertical Measurement** The posted water depth shall be the water level to the floor of the AQUATIC VENUE according to a vertical measurement taken 3 feet (0.9 m) from the AQUATIC VENUE wall.

4.5.19.9.2 **Signage** A sign shall be posted to inform the public that the AQUATIC VENUE has a varied depth and refer to the sign showing the current depth.

4.5.19.10 Spas A minimum of two depth markers shall be provided regardless of the shape or size of the SPA as per MAHC 4.12.1.6.

4.5.20 Aquatic Venue Shell Maintenance [N/A]

4.5.21^A Special Use Aquatic Venues

4.5.21.1 Adequately Support The DESIGN PROFESSIONAL shall provide information to adequately support why the SPECIAL USE AQUATIC VENUE does not meet the definition and use characteristics of other categories of AQUATIC VENUES or POOLS listed in the CODE.

4.5.21.2 Justification The DESIGN PROFESSIONAL shall provide justification to support variance requests in accordance with 5.2.3 for design parameters that do not meet the design STANDARDS and

construction requirements listed in MAHC 4.0.

4.6 Indoor / Outdoor Environment

4.6.1 Lighting

4.6.1.1 General Requirements

4.6.1.1.1 Outdoor Aquatic Venues Lighting as described in this subsection shall be provided for all outdoor AQUATIC VENUES open for use from 30 minutes before sunset to 30 minutes after sunrise, or during periods of natural illumination below the levels required in MAHC 4.6.1.3.1.

4.6.1.1.2 Accessible No lighting controls shall be accessible to PATRONS or BATHERS.

4.6.1.2^A Windows / Natural Light Where natural lighting methods are used to meet the light level requirements of MAHC 4.6.1.3 during portions of the day when adequate natural lighting is available, one of the following methods shall be used to ensure that lights are turned on when natural lighting no longer meets these requirements:

- 1) Automatic lighting controls based on light levels or time of day or
- 2) Written operations procedures where manual controls are used.

4.6.1.3^A Light Levels POOL water surface and DECK light levels shall meet the following minimum maintained light levels:

- 1) Indoor Water Surface: 30 horizontal footcandles (323 lux).
- 2) Outdoor Water Surface: 10 horizontal footcandles (108 lux).
- 3) DECK: 10 horizontal footcandles (108 lux).

4.6.1.3.1 Minimum Light Levels Maintained Where overhead lighting is adjustable to accommodate higher lighting levels for different activities, the minimum lighting level setting must ensure the minimum lighting levels are maintained as required at the POOL water surface and DECK whenever the lighting is on.

4.6.1.4^A Overhead Lighting

4.6.1.4.1^A Artificial Lighting Artificial lighting shall be provided at all AQUATIC VENUES which are to be used at night or which do not have adequate natural lighting.

4.6.1.4.2 Aquatic Venue Floor Lighting shall illuminate all parts of the floor of the AQUATIC VENUE to enable a QUALIFIED LIFEGUARD or other person to determine whether a BATHER is on the floor of the AQUATIC VENUE.

4.6.1.4.3 Aquatic Venue Illumination Lighting shall illuminate all parts of the AQUATIC VENUE including the water, the depth markers, signs, entrances, restrooms, safety equipment, and the required DECK area and walkways.

4.6.1.5^A Underwater Lighting

4.6.1.5.1^A Minimum Requirements Underwater lighting, where provided, shall be not less than eight initial rated lumens per square foot of POOL water surface area.

4.6.1.5.1.1 Location Such underwater lights, in conjunction with overhead or equivalent DECK lighting, shall be located to provide illumination so that all portions of the AQUATIC VENUE, including the AQUATIC VENUE bottom and drain(s), may be readily seen.

4.6.1.5.1.2 Higher Light Levels Higher underwater light levels shall be considered for deeper water to achieve this outcome.

4.6.1.5.2 Dimmable Lighting Dimmable lighting shall not be used for underwater lighting.

4.6.1.6^A Night Swimming with No Underwater Lighting

4.6.1.6.1 Minimum Requirements Where outdoor POOLS are open for use from 30 minutes before sunset to 30 minutes after sunrise, or during periods of low illumination, underwater lighting may be excluded where:

- 1) Maintained POOL surface lighting levels are a minimum of 15 horizontal footcandles (*161 lux*), and
- 2) All portions of the POOL, including the bottom and drain(s), are readily visible as required in MAHC 5.7.6.1.

4.6.1.7^A Emergency Lighting

4.6.1.7.1 Emergency Egress Lighting POOL areas requiring lighting shall be provided with emergency egress lighting in compliance with the applicable local, state, territorial, federal, and tribal building CODES.

4.6.1.7.2 Footcandles The path of egress shall be illuminated to at least a value of 0.5 footcandles (*5.4 lux*).

4.6.1.8^A Glare Windows and any other features providing natural light into the POOL space and overhead or equivalent DECK lighting shall be designed or arranged to inhibit or reduce glare on the POOL water surface that would prevent seeing objects on the POOL bottom.

4.6.2^A Indoor Aquatic Facility Ventilation

4.6.2.1^A Purpose INDOOR AQUATIC FACILITY AIR HANDLING SYSTEMS shall be designed, constructed, and installed to support the health and SAFETY of the building's PATRONS.

4.6.2.2^A Exemptions INDOOR AQUATIC FACILITY AIR HANDLING SYSTEM design requirements do not apply to AQUATIC FACILITIES that do not meet the definition of a "Building" in the IBC 2012.

4.6.2.3 Indoor Aquatic Facility AIR HANDLING SYSTEM design requirements shall apply to new or SUBSTANTIALLY ALTERED INDOOR AQUATIC FACILITIES including the area of the building's AQUATIC VENUES and the surrounding BATHER and spectator/STADIUM SEATING areas.

4.6.2.4 Mechanical Code INDOOR AQUATIC FACILITY AIR HANDLING SYSTEM design, construction, and installation shall comply with all applicable local, state, territorial, federal, and tribal laws.

4.6.2.5^A ASHRAE 62.1 Compliance INDOOR AQUATIC FACILITY AIR HANDLING SYSTEM design, construction, and installation shall comply with ASHRAE Standard 62.1 2019, *Ventilation for Acceptable Indoor Air Quality*, and all applicable local, state, territorial, federal, and tribal laws with additional requirements as stated in MAHC 4.6.2.6.

4.6.2.5.1 Weather Data The ASHRAE dehumidification weather data for the facility geographical location shall be used when calculating the effects of the ventilation air to the space it is being introduced. This shall be added to the evaporation load of all water surfaces when sizing the climate control equipment.

4.6.2.6 Temperature and Humidity Control

4.6.2.6.1 Mechanical Systems Ventilation shall be provided through mechanical systems and/or engineered openings for natural ventilation.

4.6.2.6.2^A Design Factors and Performance Requirements The AIR HANDLING SYSTEM design engineer shall provide plan drawings and documentation with the following components showing the design meets the performance requirements per MAHC 4.6.2.7:

- 1) Building layout identifying the geographic location of the INDOOR AQUATIC FACILITY;
- 2) INDOOR AQUATIC FACILITY size including area in square feet and height;

- 3) The surface area for DRY DECK, PERIMETER DECK, POOL DECK, POOL water surface, and for STADIUM SEATING sections;
- 4) Theoretical peak occupancy per aquatic venue, spectator, and deck spaces;
- 5) Placement of AIR HANDLING SYSTEM and other building outdoor air intakes exterior to the building;
- 6) Placement of AIR HANDLING SYSTEM and other building exhaust vents exterior to the building;
- 7) Placement of return air intakes within the INDOOR AQUATIC FACILITY;
- 8) Placement of supply air locations within the INDOOR AQUATIC FACILITY;
- 9) Identify system capabilities, if provided, to automatically or manually modulate the amount of outdoor air for the purposes of reducing the number of cfm of outdoor air when occupancy in STADIUM SEATING sections is lower than THEORETICAL PEAK OCCUPANCY;
- 10) Identify system design to maintain negative air pressure in the INDOOR AQUATIC FACILITY relative to the indoor areas external to it, or to the outside of the facility; and
- 11) Heating, cooling, and dehumidification load calculations including design envelope sensible cooling loads, envelope heating loads, ventilation sensible and latent loads, spectator sensible and latent loads (if applicable) and POOL evaporation loads.

4.6.2.6.3^A *Other Air Handling Systems* AIR HANDLING SYSTEM design for CHEMICAL STORAGE SPACES, mechanical, toilet, SHOWER, and dressing rooms are not included in the scope of this section of the CODE, but shall be considered for their effects on the performance requirements of MAHC 4.6.2.7 such as maintaining negative pressure, temperature differences, and contribution to the air volume of the INDOOR AQUATIC FACILITY.

4.6.2.6.4 *High Volume, Low Speed Fans* AIR HANDLING SYSTEM design may not consider mechanical fans used to push air within the space as part of the outdoor air calculations for the INDOOR AQUATIC FACILITY as defined in MAHC 4.6.2.7.

4.6.2.6.4.1 *Air Delivery Rate* Mechanical fans used to push air within the space may be used in the calculation for AIR DELIVERY RATE per MAHC 4.6.2.7.5.

4.6.2.6.5 *Occupied and Open All Seasons* AIR HANDLING SYSTEM design may include natural ventilation calculated in accordance with the ASHRAE Handbooks to substitute the corresponding portion of mechanical ventilation only if all the calculated exterior openings will be continuously controlled open during all times the INDOOR AQUATIC FACILITY is occupied, regardless of season.

4.6.2.6.6 *Air Distribution Design* The design of the distribution of supply air and distribution of exhaust or return air shall consider obstacles such as support columns, architectural structures, and AQUATIC FEATURES.

4.6.2.7 Performance Requirements for Air Handling Systems

4.6.2.7.1^A *Designed to Maintain* The AIR HANDLING SYSTEM shall be designed to maintain the space temperature, relative humidity and dewpoint as defined in Section 4.6.2.7. The design shall achieve the following objectives:

- 1) Maintaining homogeneous air quality, space temperature, relative humidity, and negative space pressure.
- 2) Delivering outside air to the breathing zone of swimmers, people on the DECK, and spectators.
- 3) Provide low velocity airflow low across water surfaces to prevent build-up of DBPs. If the air velocity is greater than 30 fpm (0.15 meters per second) across the water surface, the empirical Equation 1 Evaporation Formula as listed in the ASHRAE 2019 Applications Handbook (*Indoor Pool Chapter*) must be used.
- 4) Assist in removing DBPs from the space.
- 5) Provide a comfortable environment for occupants in all zones of the AQUATIC FACILITY (with an emphasis on BATHERS).

4.6.2.7.2^A Minimum Outdoor Air Requirements The AIR HANDLING SYSTEM shall have a design capability to supply no less than the minimum outdoor air requirements using ASHRAE Standard 62.1 2016, *Ventilation for Acceptable Indoor Air Quality*.

4.6.2.7.2.1 May Be Higher The minimum outdoor air requirements may be higher than the amount calculated using ASHRAE Standard 62.1 2019 Table 6.2.2.1 (*i.e., for high occupancy public POOLS and waterparks*) as determined by the DESIGN PROFESSIONAL.

4.6.2.7.3^A System Alarm The AIR HANDLING SYSTEM design shall provide system features to notify the operator if the outdoor air flow rate entering the INDOOR AQUATIC FACILITY is below 0.48 cfm/ft² (1.8 m³/h) or the minimum amount as designated by the DESIGN PROFESSIONAL for each applicable mode of operation (*e.g., occupied normal mode, occupied meet mode, unoccupied mode*).

4.6.2.7.4 Outdoor Air Rate Design of the AIR HANDLING SYSTEM for STADIUM SEATING areas shall meet the requirements in ASHRAE 62.1-2019 for the Area Outdoor Air Rate (0.06 cfm/ft²) and the People Outdoor Air Rate (7.5 cfm/person) based on the THEORETICAL PEAK OCCUPANCY of the STADIUM SEATING area. Design of the AIR HANDLING SYSTEM for all other areas of the INDOOR AQUATIC FACILITY shall meet the requirements in ASHRAE 62.1-2019 for the Area Outdoor Air Rate for POOL and DECK areas (0.48 cfm/ft²).

4.6.2.7.4.1 Method to Determine If a method to determine real-time actual occupancy is available for STADIUM SEATING areas, then the system may modulate to reduce outdoor air cfm to meet the requirement for the actual occupancy in those areas for the associated time frame.

4.6.2.7.5 Air Delivery Rate The AIR HANDLING SYSTEM shall supply an AIR DELIVERY RATE as defined in ASHRAE Handbook – HVAC Applications 2019, *Indoor Pool Design*.

4.6.2.7.5.1 Latent and Sensible The AIR DELIVERY RATE shall be sufficient to meet the latent and sensible cooling loads and the heating loads of the space and to meet the requirements of the air distribution system defined in MAHC 4.6.2.7.6 through 4.6.2.7.9

4.6.2.7.6 Constant Air Flow INDOOR AQUATIC FACILITY AIR HANDLING SYSTEM shall be designed to provide constant air flow through all parts of the INDOOR AQUATIC FACILITY to minimize any stagnant areas, stratification of temperature and humidity, and provide homogeneous air quality, space temperature, relative humidity, and pressure throughout the space.

4.6.2.7.7^A Relative Humidity The AIR HANDLING SYSTEM shall maintain the relative humidity in the space as defined in ASHRAE Handbook: HVAC Applications, 2019, Chapter 6.

4.6.2.7.7.1 Dew Point The AIR HANDLING SYSTEM shall be designed to maintain the dew point as defined in Technical Details section 4.6.2.6.2. The DESIGN PROFESSIONAL shall design the ENCLOSURE to limit condensation on surfaces of the INTERIOR SPACE as prescribed by the DESIGN PROFESSIONAL to ensure condensation is avoided on wall, ceiling, glass, and floor interior surface as well as the interior structure of these building components at all times so as to prevent damage to structural members and to prevent biological growth on walls.

4.6.2.7.7.2 Condensation & Mold Control The AIR HANDLING DISTRIBUTION SYSTEM shall be designed to inhibit condensation and mold by:

- 1) Maintaining homogeneous space conditions and
- 2) Flushing the outside walls and windows, which can have the lowest surface temperature and therefore the greatest chance for condensation.

4.6.2.7.8 Negative Air Pressure AIR HANDLING SYSTEM air flow shall be designed to maintain negative air pressure in the INDOOR AQUATIC FACILITY relative to the areas external to it (*such as adjacent indoor spaces and outdoor ambient space*).

4.6.2.7.9^A Disinfection By-Product Removal Sufficient return/exhaust air intakes shall be placed near AQUATIC VENUE surfaces such that they remove the highest concentration of airborne DBPs.

4.6.2.7.9.1 Airflow Across Water Surface The AIR HANDLING SYSTEM shall be designed considering airflow across the water surface to promote removal of DBPs.

4.6.2.7.9.1.1 Sufficient Return Air Intakes Sufficient return air intakes shall be placed low in the space near AQUATIC VENUE surfaces such that they draw air across the water surfaces and pull in the highest concentration of airborne DBPs.

4.6.2.7.9.1.2 Source Capture Provided Where a source capture exhaust system is provided, the AIR HANDLING SYSTEM shall be designed to help move the air on the water surface towards the exhaust. This exhaust air should not be allowed to mix with any return airflow in the AIR HANDLING SYSTEM.

4.6.2.7.9.1.3 Air Velocities Air velocities shall not exceed 30 fpm (0.15 meters per second) so as not to increase the evaporation rate and dehumidification requirement unless adjustments are made to the evaporation rate as stated in section 4.6.2.7.1.

4.6.2.7.10 Re-Entrainment of Exhaust and Contaminants AIR HANDLING SYSTEM outdoor air intakes shall be located to avoid RE-ENTRAINMENT of exhaust air and contaminants from building systems including AIR HANDLING SYSTEM exhaust back into the facility.

4.6.2.7.10.1 System Exhaust AIR HANDLING SYSTEM exhaust from CHEMICAL STORAGE SPACES, mechanical, toilet, SHOWER, and dressing rooms shall not be directed into the AQUATIC FACILITY.

4.6.2.7.11 Access Control The AIR HANDLING SYSTEM shall be designed to provide a means to limit physical or electronic access to system control to the operator and anyone the operator deems to have access.

4.6.2.7.12^A Purge The AIR HANDLING SYSTEM shall have the capability to periodically PURGE air for air quality maintenance or for emergency situations.

4.6.2.7.12.1 Purge Capacity The AIR HANDLING SYSTEM shall have a PURGE capacity equal or greater than two times the ASHRAE Standard 62.1 2019 level.

4.6.2.7.12.1.1 Manual Activation This PURGE shall be capable of being manually activated.

4.6.2.7.12.2 Outdoor Air If a system is designed with a purge mode, the outdoor air delivered during PURGE shall be heated or conditioned to a temperature and humidity established by the HVAC design engineer to address any condensation in the duct system, the AIR HANDLING SYSTEM, and the building surfaces.

4.6.2.7.13^A Air Handling System Filters The AIR HANDLING SYSTEM design shall include filters for outdoor air and recirculated air with a MERV rating of 8.

4.6.2.8 Air Handling System Installation

4.6.2.8.1 Air Handling System Operation and Maintenance Manual The contractor installing the INDOOR AQUATIC FACILITY AIR HANDLING SYSTEM shall provide the AQUATIC FACILITY owner with an operations and maintenance manual. Information to be included:

- 1) Mechanical drawing and specifications;
- 2) All manufacturers' operation and maintenance manuals;
- 3) All equipment startup and shutdown procedures;
- 4) PURGING and other SAFETY procedures;
- 5) Cleaning procedures;
- 6) General maintenance requirements with STANDARD replaceable parts listings and frequency of maintenance (*e.g., filter cleaning frequencies, motor bearing maintenance*);
- 7) Pressure differential specifications for filter replacement, filter replacement type, and frequency of cleaning or replacement;

- 8) Troubleshooting processes;
- 9) Frequency of required calibration of equipment;
- 10) Descriptions of general operating schemes; and
- 11) Contact information for all air handling manufacturers and their local representatives or authorized service companies.

4.6.2.9 Air Handling System Commissioning

4.6.2.9.1 System Commissioning A qualified, licensed professional shall commission the AIR HANDLING SYSTEM to verify that the installed system is operating properly in accordance with the system design.

4.6.2.9.2 Written Statement A written statement of commissioning shall be provided to the AQUATIC FACILITY owner including but not limited to:

- 1) The cfm outdoor air flowing into the INDOOR AQUATIC FACILITY during all modes of operation shall be verified at the time of commissioning,
- 2) The exhaust air cfm flowing through the system during all modes of operation shall be verified at the time of commissioning,
- 3) The supply air cfm flowing into the space and resulting air changes per hour during all modes of operation shall be verified at the time of commissioning, and
- 4) Air velocity measurements at 6 different locations around the POOL DECK area at 12 inches above the DECK surface.

4.6.3^A Indoor/Outdoor Aquatic Facility Electrical Systems and Components

4.6.3.1^A General Guidance

4.6.3.1.1 NEC Requirements Electrical wiring and systems shall comply with the requirements of the NEC.

4.6.3.1.1.1 Providing Relief Nothing in this CODE shall be construed as providing relief from any applicable requirements of the NEC or other applicable CODE.

4.6.3.1.2^A Indoor Aquatic Facilities An INDOOR AQUATIC FACILITY shall be considered a wet and corrosive environment.

4.6.3.2^A Electrical Equipment in Interior Chemical Storage Spaces

4.6.3.2.1^A Wet and Corrosive CHEMICAL STORAGE SPACES shall be considered wet and corrosive environments.

4.6.3.2.2^A Electrical Conduit Electrical conduit shall not enter or pass through an interior CHEMICAL STORAGE SPACE, except as required to service devices integral to the function of the room, such as pumps, vessels, controls, lighting and safety devices, or if allowed by the NEC.

4.6.3.2.2.1 Sealed and Inert Where required, the electrical conduit in an interior CHEMICAL STORAGE SPACE shall be sealed and made of materials that will not interact with any chemicals in the CHEMICAL STORAGE SPACE.

4.6.3.2.3^A Electrical Devices Electrical devices or equipment shall not occupy an interior CHEMICAL STORAGE SPACE, except as required to service devices integral to the function of the room, such as pumps, vessels, controls, lighting, and safety devices.

4.6.3.2.4^A Protected Against Breakage Lamps, including fluorescent tubes, installed in interior CHEMICAL STORAGE SPACES shall be protected against breakage with a lens or other cover, or be otherwise protected against the accidental release of hot materials.

4.6.4^A Pool Water Heating

4.6.4.1^A High Temperature When designing POOL heating equipment, measures shall be taken to prevent BATHER exposure to water temperatures in excess of 104°F (40°C).

4.6.4.2 Pressure Relief Device A listed pressure-relief device shall be installed to limit the pressure on the heating equipment to no more than the maximum value specified by the heating-equipment manufacturer and applicable CODES.

4.6.4.3 Code Compliance POOL-water heating equipment shall be selected and installed to preserve compliance with the applicable CODES, the terms of listing and labeling of equipment, and with the equipment manufacturer's installation instructions and applicable CODES.

4.6.4.4^A Equipment Room Requirements Where POOL water heaters use COMBUSTION and are located inside a building, the space in which the heater is located shall be considered to be an EQUIPMENT ROOM, and the requirements of MAHC 4.9.1 shall apply.

4.6.4.4.1 Carbon Monoxide Detector A carbon monoxide detector with local alarming, CERTIFIED, LISTED, AND LABELED in accordance with UL 2075, shall be installed in all such EQUIPMENT ROOMS.

4.6.4.4.2 Adjacent Rooms All rooms that are immediately adjacent to spaces containing fuel burning equipment or vents carrying the products of combustion shall also be provided with locally alarming carbon monoxide detectors.

4.6.4.5 Exception Heaters CERTIFIED, LISTED, AND LABELED for the atmosphere shall be acceptable without isolation from chemical fumes and vapors.

4.6.5 First Aid Area

4.6.5.1^A Station Design Design and construction of new AQUATIC FACILITIES shall include an area designated for first aid equipment and/or treatment.

4.6.6 Emergency Exit

4.6.6.1 Labeling Gates and/or doors which will allow egress without a key shall be clearly and conspicuously labeled in letters at least 4 inches (10.2 cm) high "EMERGENCY EXIT."

4.6.7 Drinking Fountains

4.6.7.1^A Provided A drinking fountain shall be provided inside an AQUATIC FACILITY and shall be CERTIFIED, LISTED, AND LABELED to NSF/ANSI 61-2020 and, if electric, UL 399.

4.6.7.1.1 Alternative Alternate locations or the use of bottled water shall be evaluated by the AHJ.

4.6.7.1.2 Common Use Area If the drinking fountain cannot be provided inside the AQUATIC FACILITY, it shall be provided in a common use building or area adjacent to the AQUATIC FACILITY entrance and on the normal path of BATHERS going to the AQUATIC FACILITY entrance.

4.6.7.2 Readily Accessible The drinking fountain shall be located where it is readily accessible and not a hazard to BATHERS per MAHC 4.10.2.

4.6.7.2.1 Not Located The drinking fountain shall not be located in a SHOWER area or toilet area.

4.6.7.3 Single Fountain A single drinking fountain shall be allowed for one or more AQUATIC VENUES within an AQUATIC FACILITY.

4.6.7.4 Angle Jet Type The drinking fountain shall be an angle jet type installed according to applicable plumbing CODES.

4.6.7.5 Potable Water Supply The drinking fountain shall be supplied with water from an approved

potable water supply.

4.6.7.6 Wastewater The wastewater discharged from a drinking fountain shall be routed to an approved sanitary sewer system or other approved disposal area according to applicable plumbing CODES.

4.6.8 Garbage Receptacles

4.6.8.1 Sufficient Number Receptacles shall be provided within an AQUATIC FACILITY to ensure that garbage and refuse can be disposed of properly to maintain safe and sanitary conditions.

4.6.8.2 Number and Location The number and location of receptacles shall be at the discretion of the AQUATIC FACILITY manager.

4.6.8.3 Closable Receptacles shall be designed to be closed with a lid or other cover so they remain closed until intentionally opened.

4.6.9 Food and Drink Concessions

4.6.9.1 Meet AHJ Requirements Concessions for food and drink in an AQUATIC FACILITY shall meet all AHJ requirements.

4.6.10 Spectator Areas

4.6.10.1 Within Aquatic Facility Enclosure An area designed for use by spectators may be located within an AQUATIC FACILITY ENCLOSURE.

4.6.10.2 Deck When a spectator area or an access to a spectator area is located within the AQUATIC FACILITY ENCLOSURE, the DECK adjacent to the area or access shall provide egress width for the spectators in addition to the width required by MAHC 4.8.1.5.

4.6.10.2.1 Additional Width The additional width shall be based on the egress requirements in the applicable building CODE based on the THEORETICAL PEAK OCCUPANCY of the AQUATIC FACILITY served with a minimum width of 4 feet (1.2 m) and have either of the following qualities outlined in MAHC 4.6.10.2.1.1 or MAHC 4.6.10.2.1.2.

4.6.10.2.1.1 Barrier A BARRIER as defined in MAHC 4.8.6.1 located on the DECK to separate the DECK used by spectators from the PERIMETER DECK used by BATHERS.

4.6.10.2.1.1.1 Openings The BARRIER may have one or more openings directly into the BATHER areas.

4.6.10.2.1.2 Demarcation Line A demarcation line on the DECK that shows the separation between the DECK used by spectators and the PERIMETER DECK used by BATHERS.

4.6.10.3^A Balcony A spectator or other area located in a balcony within 10 feet (3.0 m) of or overhanging any portion of an AQUATIC VENUE shall be designed to prevent jumping or diving into the AQUATIC VENUE.

4.6.10.4^A Bleachers Bleachers in a spectator area shall be designed according to the ICC's most recent version of the 300 Standard or another applicable CODE.

4.6.11 Indoor Aquatic Facility Acoustics

4.6.11.1^A Acoustic Design Criteria Acoustic design requirements shall apply to a new INDOOR AQUATIC FACILITY or one that undergoes SUBSTANTIAL ALTERATION.

4.6.11.2^A Sound Absorption INDOOR AQUATIC FACILITIES shall be designed, constructed, and installed with an AVERAGE SOUND ABSORPTION COEFFICIENT (ALPHA BAR) of 0.20 or greater.

4.6.11.2.1^A Facilities Used Primarily by Specific Hearing Populations An ALPHA BAR of 0.25 or greater shall be used for INDOOR AQUATIC FACILITIES designed primarily for use by children, the elderly, or persons with hearing difficulties.

4.6.11.3^A Noise INDOOR AQUATIC FACILITIES shall be designed, constructed, and installed so that the noise generated by the AIR HANDLING SYSTEM does not exceed a NOISE CRITERION level of 50 (NC-50) or 55 dBA at any time while the INDOOR AQUATIC FACILITY is open for use.

4.6.11.4^A Sound Absorbing Materials When part of the interior finish, acoustical materials or finishes used for SOUND ABSORPTION shall meet the design requirements of MAHC 4.2.2.1.1 and 4.2.2.2.3.

4.6.11.5^A Concave Room Surfaces The design of INDOOR AQUATIC FACILITIES with a domed roof, gable roof, or other shape that may cause sound focusing, irrespective of the ALPHA BAR, shall address sound focusing, REVERBERATION, and echoes that would interfere with speech intelligibility.

4.7 Recirculation and Water Treatment

4.7.1 Recirculation Systems and Equipment

4.7.1.1^A General

4.7.1.1.1 *Equipped and Operated* All AQUATIC VENUES shall be equipped and operated with a recirculation and filtration system capable of meeting the provisions outlined in MAHC 4.7.

4.7.1.1.2 *Component Installation* The installation of the recirculation and the filtration system components shall be performed in accordance with the designer's and manufacturer's instructions.

4.7.1.1.3 *Recirculation System* A water RECIRCULATION SYSTEM consisting of one or more pumps, pipes, return INLETS, suction outlets, tanks, filters, and other necessary equipment shall be provided.

4.7.1.2^A Combined Aquatic Venue Treatment

4.7.1.2.1 *Maintain and Measure* When treatment systems of multiple AQUATIC VENUES are combined, the design shall include all appurtenances to maintain and measure the required water characteristics including but not limited to flow rate, pH, and disinfectant concentration in each AQUATIC VENUE or AQUATIC FEATURE.

4.7.1.2.2 *Secondary Treatment* If SECONDARY TREATMENT is required for an INCREASED RISK AQUATIC VENUE as per MAHC 4.7.3.3.1.2, then SECONDARY TREATMENT shall be required for all treatment systems that are combined with the INCREASED RISK AQUATIC VENUE.

4.7.1.2.3 *Isolate* When multiple AQUATIC VENUES are combined in one treatment system, each AQUATIC VENUE shall be capable of being isolated for maintenance purposes.

4.7.1.3 Inlets

4.7.1.3.1^A General

4.7.1.3.1.1 *Hydraulically Balanced* The RECIRCULATION SYSTEM shall be designed with sufficient flexibility to achieve a hydraulic apportionment that will ensure the following:

- 1) Effective distribution of treated water and
- 2) Maintenance of a uniform disinfectant residual and pH throughout the AQUATIC VENUE.

4.7.1.3.1.1.1^A *Alternative Design Justification* Alternative designs shall be allowed based on adequate engineering justification which may include utilizing a computation fluid dynamics (CFD) model of the POOL design that documents in-POOL circulation without any dead zones.

4.7.1.3.1.2 *Inlets* Effective distribution of treated water shall be accomplished by either a continuous perimeter overflow system with integral INLETS or by means of directionally adjustable INLETS adequate in design, number, and location.

4.7.1.3.1.3 *Adequate Mixing* POOLS shall use wall and/or floor INLETS to provide adequate mixing.

4.7.1.3.1.3.1 Greater Than Fifty Feet Wide For POOLS greater than 50 feet wide (15.2 m), floor INLETS shall be required.

4.7.1.3.1.4 Other Inlet Types All other types of INLET systems not covered in this section shall be subject to approval by the AHJ with proper engineering justification to support a variance request under MAHC 5.2.3.

4.7.1.3.1.5 Hydraulically Sized INLETS shall be hydraulically sized to provide the design flow rates for each POOL area of multi-zone POOLS based on the required design TURNOVER RATE for each zone.

4.7.1.3.2^A Floor Inlets

4.7.1.3.2.1 Uniformly Spaced Floor INLETS shall be spaced to effectively distribute the treated water throughout the POOL.

4.7.1.3.2.2 Flush with Bottom Floor INLETS shall be flush with the bottom of the POOL.

4.7.1.3.2.2.1 Distance Distance between floor INLETS shall be no greater than 20 feet (6.1 m).

4.7.1.3.2.2.2 Row A row of floor INLETS shall be located within 15 feet (4.6 m) of each side wall.

4.7.1.3.2.3 Spaced Floor INLETS, used in combination with wall INLETS, shall be spaced no greater than 25 feet (7.6 m) from nearest side walls.

4.7.1.3.3 Wall Inlets

4.7.1.3.3.1^A Effective Mixing Wall INLET velocity shall mix the water effectively.

4.7.1.3.3.2 Adjustable INLETS shall be directionally adjustable to provide effective distribution of water.

4.7.1.3.3.3^A Inlet Spacing Wall INLETS shall be spaced no greater than 20 feet (6.1 m) apart.

4.7.1.3.3.3.1 Corner INLETS shall be placed within 5 feet (1.5 m) of each corner of the POOL.

4.7.1.3.3.3.2 Skimmers INLETS shall be placed at least 5 feet (1.5 m) from a SKIMMER.

4.7.1.3.3.3.3 Isolated INLETS shall be placed in each recessed or isolated area of the POOL.

4.7.1.3.3.4 Directional Flow Wall INLETS shall not require design to provide directional flow if part of a manufactured gutter system in which the filtered return water conduit is contained within the gutter structure.

4.7.1.3.3.5^A Dye Testing The AHJ may require dye testing to evaluate the mixing characteristics of the RECIRCULATION SYSTEM.

4.7.1.3.3.5.1 Failed Test If dye test reveals inadequate mixing in the POOL after 20 minutes, the RECIRCULATION SYSTEM shall be adjusted or modified to assure adequate mixing.

4.7.1.4 Perimeter Overflow Systems/Gutters

4.7.1.4.1 General

4.7.1.4.1.1^A Skimming All POOLS shall be designed to provide SKIMMING for the entire POOL surface area with engineering rationale provided by the DESIGN PROFESSIONAL.

4.7.1.4.1.1.1 Around Entire Pool For POOLS that require a perimeter overflow system, the perimeter overflow system shall extend around the entire POOL perimeter except where noted in this CODE.

4.7.1.4.1.1.2^A Novel Perimeter Overflow Systems Novel perimeter overflow system

designs that do not extend around the entire POOL perimeter shall be permitted with proper engineering justification.

4.7.1.4.1.2 Zero Depth Entry ZERO DEPTH ENTRY POOLS shall have a continuous overflow trench that terminates as close to the side walls as practical including any zero-depth portion of the POOL perimeter.

4.7.1.4.1.2.1 Ends Where a perimeter overflow system cannot be continuous, the ends of each section shall terminate as close as practical to each other.

4.7.1.4.2^A Perimeter Overflow System Size and Shape

4.7.1.4.2.1 Continuous Water Removal The gutter system shall be designed to allow continuous removal of water from the POOL'S upper surface at a rate of at least 125 percent of the total design recirculation flow rate.

4.7.1.4.2.2 Inspection Gutters shall permit ready inspection, cleaning, and repair.

4.7.1.4.3^A Gutter Outlets Drop boxes, converters, return piping, or FLUMES used to convey water from the gutter shall be designed to:

- 1) Prevent flooding and BACKFLOW of skimmed water into the POOL and
- 2) Handle at least 125 percent of the total design recirculation flow rate.

4.7.1.4.4 Surge Tank Capacity

4.7.1.4.4.1^A Net Surge Capacity All perimeter overflow systems shall be designed with an effective net surge capacity of not less than one gallon for each square foot ($40.7 L/m^2$) of POOL surface area.

4.7.1.4.4.1.1 Surge Components Surge shall be provided within a surge tank, or the gutter or filter above the normal operating level, or elsewhere in the system.

4.7.1.4.4.2 Tank Capacity The tank capacity specified shall be the net capacity.

4.7.1.4.4.3 Tank Levels The DESIGN PROFESSIONAL shall define the minimum, maximum, and normal POOL operating water levels in the surge tank.

4.7.1.4.4.3.1 Marked The surge tank's minimum, maximum, and normal POOL operating water levels shall be marked on the tank so as to be readily visible for inspection.

4.7.1.4.4.4 Overflow Pipes Surge tanks shall have overflow pipes to convey excess water to waste via an air gap or other approved BACKFLOW prevention device.

4.7.1.4.5^A Tolerances Gutters shall be level within a tolerance of plus or minus $1/16$ inch ($1.6 mm$) around the perimeter of the AQUATIC VENUE.

4.7.1.4.6^A Makeup Water System

4.7.1.4.6.1 Automatic Makeup Automatic makeup water supply equipment shall be provided to maintain continuous skimming of POOLS with Perimeter Overflow Systems.

4.7.1.4.6.2 Air Gap Makeup water shall be supplied through an air gap or other approved BACKFLOW prevention device.

4.7.1.5 Skimmers and Alternative Gutter Technologies Using In-Pool Surge Capacity

4.7.1.5.1 General

4.7.1.5.1.1 Manufactured The use of manufactured direct suction SKIMMERS shall be in accordance with the manufacturer's recommendations.

4.7.1.5.1.2^A Provided Where SKIMMERS are used, at least one surface SKIMMER shall be provided for each 500 square feet ($46 m^2$) of surface area or fraction thereof.

4.7.1.5.1.2.1 **Conditions** Additional SKIMMERS may be required to achieve effective skimming under site-specific conditions such as outdoor POOLS affected by winds or heavy CONTAMINANT loading.

4.7.1.5.1.3^A **Hybrid Systems** Hybrid systems that incorporate surge weirs in the overflow gutters to provide for in-POOL surge shall meet all of the requirements specified for overflow gutters—with the exception of the requirements under 4.7.1.4.4 when the net surge capacity required by 4.7.1.4.4.1 is alternatively met by the in-POOL surge capacity.

4.7.1.5.1.3.1^A **Surge Weirs** The number of surge weirs shall be based on the individual surge weir capacity and the operational apportionment of the total design recirculation flow rate.

4.7.1.5.1.3.1.1 **Locations** The location of the required number of surge weirs shall be uniformly spaced in the gutter sections.

4.7.1.5.1.4^A **Design Capacity** When used, the SKIMMER SYSTEM shall be designed to handle up to 100% of the total design recirculation flow rate.

4.7.1.5.1.5 **Pool Width Limitations** POOLS using SKIMMERS shall not exceed 30 feet (9.1 m) in width.

4.7.1.5.2 **Skimmer Location**

4.7.1.5.2.1 **Effective** SKIMMERS shall be so located as to provide effective skimming of the entire water surface.

4.7.1.5.2.2 **Steps and Recessed Areas** SKIMMERS shall be located so as not to be affected by restricted flow in areas such as near steps and within small recesses.

4.7.1.5.2.3 **Wind Direction** Wind direction shall be considered in number and placement of SKIMMERS.

4.7.1.5.3^A **Skimmer Flow Rate** The flow rate for the SKIMMERS shall comply with manufacturer data plates or NSF/ANSI 50 including Annex K.

4.7.1.5.4 **Control**

4.7.1.5.4.1 **Weir** Each SKIMMER shall have a weir that adjusts automatically to variations in water level over a minimum range of 4 inches (10.2 cm).

4.7.1.5.4.2 **Trimmer Valve** Each SKIMMER shall be equipped with a trimmer valve capable of distributing the total flow between individual SKIMMERS.

4.7.1.5.5 **Tolerances**

4.7.1.5.5.1 **Skimmer Base** The base of each SKIMMER shall be level with all other SKIMMERS in the POOL within a tolerance of plus or minus ¼ inch (6.4 mm).

4.7.1.6^A **Submerged Suction Outlet**

4.7.1.6.1 **General** Submerged suction outlet fitting assemblies (SOFAs), shall be CERTIFIED, LISTED, AND LABELED to the requirements of ANSI/APSP/ICC-16 2017 and shall be installed in accordance with the SOFA specific installation instructions, including minimum sump depth, pipe size(s), adapters frames, structural supports, and fasteners.

4.7.1.6.2 **Number and Location** SOFAs labeled as blockable shall be installed with a minimum of two fittings. SOFAs labeled unblockable shall be installed with one or more fittings, except for those installed and used as ANSI/APSP/ICC-16 Maintenance Drains or Fire Suppression Source Outlets (ref. ¶1.2.2), which may be a single outlet.

4.7.1.6.2.1 **Flow Ratings** SOFA system flow ratings shall be calculated as follows: 1) Blockable SOFA systems: the sum of the installation specific SOFA flow ratings minus the flow rating of a SOFA with the highest installed flow rating; 2) Unblockable SOFA systems: the sum of the installation specific flow

rating(s).

4.7.1.6.2.1.1 Location SOFAs or outlets may be located on the bottom or side wall. Maintenance drains and SOFAs used to drain the POOL shall be located on the bottom and at the deepest point to achieve the objective of MAHC 4.5.2.3.

4.7.1.6.2.1.2 Connected Multiple outlets shall be connected to a single main suction pipe by branch line pipe that is not valved so as to be capable of operating independently.

4.7.1.6.2.2 Spaced Outlets shall be spaced within the minimum and maximum separation distances specified by SOFA specific installation instructions and spaced as specified by the DESIGN PROFESSIONAL for aesthetic and engineering reasons.

4.7.1.6.3 Tank Connection Where gravity outlets are used, the main drain outlet shall be connected to a surge tank, collection tank, or balance tank/pipe.

4.7.1.6.4^A Flow Distribution and Control

4.7.1.6.4.1 Design Capacity The submerged suction outlet system piping shall be designed at a minimum to handle the total design recirculation flow rate.

4.7.1.6.4.1.1 Two Main Drain Outlets Where there are two main drain outlets, the branch pipe from each main drain outlet shall be designed to carry 100% of the total design recirculation flow rate.

4.7.1.6.4.1.2 Three or More Drains Where three or more main drain outlets are connected by branch piping in accordance with MAHC 4.7.1.6.2.1.1 through MAHC 4.7.1.6.2.1.3, the design flow through each branch pipe from each main drain outlet may be as follows:

- 1) Q_{\max} for each drain = Q (total design recirculation flow rate) / (number of drains less one) and
- 2) $Q_{\max} = Q_{\text{total}} / (N - 1)$.

4.7.1.6.4.2 Proportioning Valve The single main drain suction pipe to the pump shall be equipped with a proportioning valve(s) to adjust the flow distribution between the main drain piping and the surface overflow system piping.

4.7.1.6.5 Flow Velocities

4.7.1.6.5.1 Standards Flow velocities shall meet ANSI/APSP-16 20171 based on 100% design flow through each main drain cover.

4.7.1.7 Piping

4.7.1.7.1 Design

4.7.1.7.1.1 Materials Piping system components in contact with swimming POOL water shall be of non-toxic material, resistant to corrosion, able to withstand operating pressures, chemicals, and temperatures.

4.7.1.7.1.2 Standards Piping and piping system component materials shall be suitable for potable water contact.

4.7.1.7.1.2.1 Certified, Listed, and Labeled Piping and piping system component materials shall be CERTIFIED, LISTED, AND LABELED to NSF/ANSI 14, NSF/ANSI 50, and NSF/ANSI 61, as applicable.

4.7.1.7.1.2.2 Certified Piping and piping system component materials shall be CERTIFIED, LISTED, AND LABELED to a specific STANDARD by an ANSI-accredited certification organization.

4.7.1.7.2 Velocity in Pipes

4.7.1.7.2.1^A Discharge Piping RECIRCULATION SYSTEM piping shall be designed so that water velocities do not exceed 8 feet (2.4 m) per second on the discharge side of the recirculation pump unless alternative values have proper engineering justification.

4.7.1.7.2.2^A **Suction Piping** Suction piping shall be sized so that the water velocity does not exceed 6 feet per second (*1.8 m/s*) unless alternative values have proper engineering justification.

4.7.1.7.2.3^A **Additional Considerations** Gravity piping shall be sized with consideration of available system head or as demonstrated by detailed hydraulic calculations at the total design recirculation flow rate.

4.7.1.7.3^A **Drainage and Installation**

4.7.1.7.3.1 **Temperature Variations** Provisions shall be made for expansion and contraction of pipes due to temperature variations.

4.7.1.7.3.2 **Drainage** Provisions shall be made for complete drainage of all AQUATIC VENUE piping.

4.7.1.7.3.3 **Supported** All piping shall be supported continuously or at sufficiently close intervals to prevent sagging and settlement.

4.7.1.7.4 **Piping and Component Identification**

4.7.1.7.4.1^A **Clearly Marked** All exposed piping shall be clearly marked to indicate function.

4.7.1.7.4.2 **Flow Direction and Source** All piping shall be clearly marked to indicate type or source of water and direction of flow with clear labeling and/or color coding.

4.7.1.7.4.3 **Valves** All valves shall be clearly marked to indicate function with clear labeling and/or color coding.

4.7.1.7.4.4 **Schematic Displayed** A complete, easily readable schematic of the entire AQUATIC VENUE RECIRCULATION SYSTEM shall be openly displayed in the mechanical room or available to maintenance and inspection personnel.

4.7.1.7.5 **Testing**

4.7.1.7.5.1 **Static Water Pressure Test** Suction and supply POOL piping shall be subjected to a static hydraulic water pressure test for the duration specified by the DESIGN PROFESSIONAL or AHJ.

4.7.1.7.5.2 **Greater** Suction and supply AQUATIC VENUE piping shall be able to maintain the greater of the two following amounts of pressure:

- 1) 25% greater than the maximum design operating pressure of the system or
- 2) 25 psi (*172 KPa*).

4.7.1.8 **Strainers and Pumps**

4.7.1.8.1 **Strainers**

4.7.1.8.1.1 **Strainer / Screen** All filter recirculation pumps, except those for vacuum filter installations, shall have a strainer/screen device on the suction side to protect the filtration and pumping equipment.

4.7.1.8.1.2 **Materials** Strainers shall be CERTIFIED, LISTED, AND LABELED to NSF/ANSI 50.

4.7.1.8.2 **Pumping Equipment**

4.7.1.8.2.1^A **Variable Frequency Drives** VFDs *may* be installed to control all recirculation and feature pumps.

4.7.1.8.2.2^A **Total Dynamic Head** The recirculation pump(s) shall have adequate capacity to meet the total design recirculation flow rate at the maximum TDH required by the entire RECIRCULATION SYSTEM under the most extreme operating conditions (*e.g., clogged filters in need of backwashing*).

4.7.1.8.2.3 **Required Flow Rate** The pump shall be designed to maintain total design recirculation flow rate under all conditions.

4.7.1.8.2.4 Vacuum Limit Switches Where vacuum filters are used, a vacuum limit switch shall be provided on the pump suction line.

4.7.1.8.2.5 Maximum The vacuum limit switch shall be set for a maximum vacuum of 18 inches (45.7 cm) of mercury.

4.7.1.8.2.6 Pump Priming All recirculation pumps shall be self-priming or flooded-suction.

4.7.1.8.2.7 Net Positive Suction Head Requirement All recirculation pumps shall meet the minimum NPSH requirement for the system.

4.7.1.8.3^A Operating Gauges

4.7.1.8.3.1 Vacuum Gauge A compound vacuum-pressure gauge shall be installed on the pump suction line as close to the pump as possible.

4.7.1.8.3.2 Suction Lift A vacuum gauge shall be used for pumps with suction lift.

4.7.1.8.3.3 Installed A pressure gauge shall be installed on the pump discharge line adjacent to the pump.

4.7.1.8.3.4 Easily Read Gauges shall be installed so they can be easily read.

4.7.1.8.3.5 Valves All gauges shall be equipped with valves to allow for servicing under operating conditions.

4.7.1.9 Flow Measurement and Control

4.7.1.9.1^A Flow Meters A flow meter accurate to within +/- 5% of the actual design flow shall be provided for each filtration system.

4.7.1.9.1.1 Certified, Listed, and Labeled Flow meters shall be CERTIFIED, LISTED, AND LABELED to NSF/ANSI 50 by an ANSI-accredited certification organization.

4.7.1.9.2 Valves All pumps shall be installed with a manual adjustable discharge valve to provide a backup means of flow control as well as for system isolation.

4.7.1.10^A Flow Rates / Turnover Times

Table 4.7.1.10: Aquatic Venue Maximum Allowable Turnover Times

Type of Pools	Turnover Maximum
Activity Pools	2 hours or less
Diving Pools	8 hours or less
Interactive Water Play*	0.5 hours or less
Lazy River	2 hours or less
Plunge Pools	1 hour or less
Runout Slide	1 hour or less
Wading Pools*	1 hour or less
Wave Pools	2 hours or less
All Other Pools	6 hours or less
Surf Pools	Submit engineering justification from equipment manufacturer

*Shall have secondary treatment

Aquatic Venue Maximum Allowable Turnover Times for Spa, Therapy*, & Exercise Pools

<i>Temperatures</i>	<i>Load</i>	<i>Turnover Maximum</i>
≤ 72 ⁰ –93 ⁰ F (22 ⁰ –34 ⁰ C)	> 2,500 gals/person (9.46 m ³)	4 hours or less
≤ 72 ⁰ –93 ⁰ F (22 ⁰ –34 ⁰ C)	> 450 gals/person (1.7 m ³)	2 hours or less
≤ 72 ⁰ –93 ⁰ F (22 ⁰ –34 ⁰ C)	≤ 450 gals/person (1.7 m ³)	1 hour or less
≥ 93 ⁰ –104 ⁰ F (34 ⁰ –40 ⁰ C)	All	0.5 hours or less

*Shall have secondary treatment

4.7.1.10.1 *Maximum Allowable* All AQUATIC VENUES shall comply with the above maximum allowable TURNOVER TIMES shown in MAHC Table 4.7.1.10.

4.7.1.10.2^A *Calculated* The TURNOVER TIME shall be calculated based on the total volume of water divided by the total design recirculation flow rate through the filtration process.

4.7.1.10.2.1^A *Unfiltered Water* Unfiltered water such as water that may be withdrawn from and returned to the AQUATIC VENUE for such AQUATIC FEATURES as SLIDES by a pump separate from the filtration system, shall not factor into TURNOVER TIME.

4.7.1.10.3^A *Turnover Times* TURNOVER TIMES shall be calculated based solely on the flow rate through the filtration system.

4.7.1.10.3.1 *Required* The required TURNOVER TIME shall be the lesser of the following options:

- 1) The specified time in MAHC Table 4.7.1.10 or
- 2) The time required for individual components (*e.g., three SKIMMERS with flow rates set by the manufacturer and an additional 20% for the main drains could exceed the minimum value in the table*).

4.7.1.10.3.2 *Total Volume* The total volume of the AQUATIC VENUE system shall include the AQUATIC VENUE and any surge/balance tank.

4.7.1.10.3.3 *Supply Water* Where water is drawn from the AQUATIC VENUE to supply water to AQUATIC FEATURES (*e.g., SLIDES, tube rides*), the water may be reused prior to filtration provided the disinfectant concentration and pH of the supply water are maintained at required levels.

4.7.1.10.4^A *Reuse Ratio* The ratio of INTERACTIVE WATER PLAY AQUATIC VENUE FEATURE water to filtered water shall be no greater than 3:1 in order to maintain the efficiency of the FILTRATION SYSTEM.

4.7.1.10.5^A *Flow Turndown System* For AQUATIC FACILITIES that intend to reduce the recirculation flow rate below the minimum required design values when the POOL is unoccupied, the flow turndown system shall be designed as follows in MAHC 4.7.1.10.5.1 through MAHC 4.7.1.10.5.2.

4.7.1.10.5.1 *Flowrate* The system flowrate shall not be reduced more than 25% lower than the minimum design requirements and only reduced when the AQUATIC VENUE is unoccupied.

4.7.1.10.5.1.1 *Clarity* The system flowrate shall only be reduced if the minimum water clarity required under MAHC 5.7.6 is met and the turbidity level in the POOL is less than 0.5 NTU.

4.7.1.10.5.1.2 *Disinfectant Concentration* The turndown system shall be required to maintain required disinfectant concentration and pH at all times.

4.7.1.10.5.2 Increase When the turndown system is also used to intelligently increase the recirculation flow rate above the minimum requirement (*e.g., in times of peak use to maintain water quality goals more effectively*), the following requirements shall be met at all times:

- 1) Velocity requirements inside of pipes (*per MAHC 4.7.1.7.2*) and
- 2) Maximum filtration system flows.

4.7.2^A Filtration

4.7.2.1 All Filters

4.7.2.1.1 Required Filtration shall be required for all AQUATIC VENUES that recirculate water.

4.7.2.1.2^A Certified, Listed, and Labeled Filters All filters shall be CERTIFIED, LISTED, AND LABELED to NSF/ANSI 50 by an ANSI-accredited certification organization or approved by the AHJ with proper engineering justification.

4.7.2.1.3 Appropriate Filter Media Filters shall use the appropriate filter media as recommended by the filter manufacturer for maximum clarity and cycle length for AQUATIC VENUE use.

4.7.2.1.4 Certified, Listed, and Labeled Filter Media All filter media, including alternative filter media, shall be CERTIFIED, LISTED, AND LABELED to NSF/ANSI 50 by an ANSI-accredited certification organization and within the size specifications provided by the filter manufacturer and NSF/ANSI 50 or approved by the AHJ with proper engineering justification.

4.7.2.2 Granular Media Filters

4.7.2.2.1^A General

4.7.2.2.1.1 Valves and Piping The granular media filter system shall have valves and piping to allow isolation, venting, complete drainage (*for maintenance or inspections*), and backwashing of individual filters.

4.7.2.2.1.2 Filtration Accessories Filtration accessories shall include the following items:

- 1) Influent pressure gauge,
- 2) Effluent pressure gauge,
- 3) Backwash sight glass or other means to view backwash water clarity, and
- 4) Manual air relief system.

4.7.2.2.2^A Filter Location and Spacing

4.7.2.2.2.1 Installed Filters shall be installed with adequate clearance and facilities for ready and safe inspection, maintenance, disassembly, and repair.

4.7.2.2.2.2 Media Removal A means and access for easy removal of filter media shall be required.

4.7.2.2.3 Filtration and Backwashing Rates

4.7.2.2.3.1^A Operate High-rate granular media filters shall be designed to operate at no more than 15 GPM per square foot (*37 m/h*) when a minimum bed depth of 15 inches (*38.1 cm*) is provided per manufacturer.

4.7.2.2.3.1.1 Less than Fifteen Inch Bed Depth When a bed depth is less than 15 inches (*38.1 cm*), filters shall be designed to operate at no more than 12 GPM per square foot (*29 m/h*).

4.7.2.2.3.2^A Backwash System Design The granular media filter system shall be designed to backwash each filter at a rate of at least 15 GPM per square foot (*37 m/h*) of filter bed surface area, unless explicitly prohibited by the filter manufacturer and approved at an alternate rate as specified in their

NSF/ANSI 50 listing.

4.7.2.2.4^A Minimum Filter Media Depth Requirements The minimum depth of filter media cannot be less than the depth specified by the manufacturer.

4.7.2.2.5 Differential Pressure Measurement Gauges Influent and effluent pressure gauges shall have the capability to measure up to a 20 pounds per square inch (138 KPa) increase in the differential pressure across the filter bed in increments of 1 pound per square inch (6.9 KPa) or less.

4.7.2.2.6^A Coagulant Injection Equipment Installation If coagulant feed systems are used, they shall be installed with the injection point located before the filters as far ahead as possible, with electrical interlocks in accordance with MAHC 4.7.3.2.1.3.

4.7.2.3 Precoat Filters

4.7.2.3.1^A Filtration Rates

4.7.2.3.1.1 Vacuum Precoat The design filtration rate for vacuum precoat filters shall not be greater than either:

- 1) 2 GPM per square foot (4.9 m/h) or
- 2) 2.5 GPM per square foot (6.1 m/h) when used with a continuous precoat media feed (commonly referred to as "body-feed").

4.7.2.3.1.2 Pressure Precoat The design filtration rate for pressure precoat filters shall not be greater than two GPM per square foot (4.9 m/h) of effective filter surface area.

4.7.2.3.1.3 Calculate The filtration surface area shall be based on the outside surface area of the media with the manufacturer's recommended thickness of precoat media and consistent with their NSF/ANSI 50 listing and labeling.

4.7.2.3.2^A Precoat Media Introduction System Process The precoat process shall follow the manufacturer's recommendations and requirements of NSF/ANSI 50.

4.7.2.3.3^A Continuous Filter Media Feed Equipment

4.7.2.3.3.1 Manufacturer Specification If equipment is provided for the continuous feeding of filter media to the filter influent, the equipment shall be used in accordance with the manufacturer's specifications.

4.7.2.3.3.2 Filter Media Discharge All discharged filter media shall be handled in accordance with all applicable local, state, territorial, federal, and tribal laws.

4.7.2.4^A Cartridge Filters

4.7.2.4.1^A Filtration Rates The design filtration rate for surface-type cartridge filter shall not exceed 0.30 GPM per square foot (0.20 L/s/m²).

4.7.2.4.2^A Supplied and Sized Filter cartridges shall be supplied and sized in accordance with the filter manufacturer's recommendation for AQUATIC VENUE use.

4.7.2.4.3^A Spare Cartridge One complete set of spare cartridges shall be maintained onsite in a clean and dry condition.

4.7.3^A Disinfection and pH Control

4.7.3.1 Chemical Addition Methods

4.7.3.1.1 Disinfection and pH DISINFECTION and pH control chemicals shall be automatically introduced through the RECIRCULATION SYSTEM.

4.7.3.1.1.1 Controller Used A chemical controller, as specified in MAHC 4.7.3.2.8 shall be provided and used for MONITORING and control of disinfectant and pH feed equipment.

4.7.3.1.1.2 **Feeder** DISINFECTION and pH control chemicals shall be added using a feeder that meets the requirements outlined in MAHC 4.7.3.2.

4.7.3.2 Feed Equipment

4.7.3.2.1^A General

4.7.3.2.1.1 **Required** Chemical feeders shall be required in new or existing AQUATIC FACILITIES upon adoption of this CODE.

4.7.3.2.1.2 **Feeders & Devices** The AQUATIC FACILITY shall be equipped with chemical feed equipment such as flow-through chemical feeders, electrolytic chemical generators, mechanical chemical feeders, chemical feed pumps, and AUTOMATED CONTROLLERS that are CERTIFIED, LISTED, AND LABELED to NSF-ANSI 50 by an ANSI-accredited certification organization.

4.7.3.2.1.2.1 **Specified by Manufacturer** Flow-through chemical feeders shall only be used with the chemical (*formulation, brand, size, and shape*) specified by the chemical feeder manufacturer.

4.7.3.2.1.3 **Interlock Controls and No or Low Flow Deactivation** For all new or SUBSTANTIALLY RENOVATED AQUATIC VENUES and within 1 year of adoption of this CODE for existing facilities, all chemical control and feed systems shall be provided with an automatic means to disable all chemical feeders for each VENUE or portion of a VENUE in the event of a low flow or no flow condition. This shall be accomplished through an electrical interlock consisting of at least two of the following:

- 1) Recirculation pump power monitor,
- 2) Flow meter/flow switch in the return line, or
- 3) Flow meter/flow switch at the chemical controller.

4.7.3.2.1.3.1 **Installed** The electrical interlock system shall be installed per manufacturer's instructions and shall never be altered.

4.7.3.2.1.3.2 **Visual Alarm** For new installations and replacement equipment, if the feeder is disabled through the electrical interlock, a visual alarm or other indication shall be initiated that will alert staff onsite for BATHER evacuation.

4.7.3.2.1.4 **Installation** The chemical control and feed systems shall be installed according to the manufacturer's instructions.

4.7.3.2.1.4.1 **Protective Cover** A physical BARRIER shall be installed between chemical feed pumps supplying acid or liquid hypochlorite solution and other POOL components to shield staff and equipment from chemical sprays from leaking connections.

4.7.3.2.2^A Sizing of Disinfection Equipment

4.7.3.2.2.1 **Sizing** Feeders shall be capable of supplying disinfectant and pH control chemicals to the AQUATIC VENUE to maintain the DISINFECTION levels and pH at all times in accordance with the MAHC.

4.7.3.2.2.2 **Chlorine Dosing** All CHLORINE dosing and generating equipment including erosion feeders, or in line electrolytic and brine/batch generators, shall be designed with a capacity to meet the demand necessary to maintain the minimum required DPD-FC CONCENTRATIONS specified in MAHC 5.7.3.1.1.2 during all times of operation.

4.7.3.2.2.2.1 **Chlorine Demand Factors** Sizing of CHLORINE dosing and generating equipment shall be based on the following CHLORINE demand factors:

- 1) AQUATIC VENUE surface area;
- 2) Aquatic venue volume;
- 3) AQUATIC VENUE type of use/space:
 - a. Flat Water,

- b. Agitated Water, or
 - c. Hot Water;
- 4) Aquatic venue type, for example: pool, spa, wading pool, wave pool (*wave time*), waterslide, interactive water play venue, therapy pool;
 - 5) Indoor or outdoor including maximum hours of sunlight/UV exposure;
 - 6) Anticipated maximum water temperature;
 - 7) Anticipated maximum number of BATHERS per day;
 - 8) Cyanuric acid/stabilizer used;
 - 9) Anticipated atypical water loss; and
 - 10) Anticipated exposure to vegetation and airborne debris.

4.7.3.2.2.3 Documentation The DESIGN PROFESSIONAL, who is registered or licensed to practice their respective design profession as defined by the local, state, territorial, federal, and tribal laws governing professional practice within the jurisdiction where the project is to be constructed, shall provide adequate documentation to demonstrate the selected feeders/equipment are of sufficient size and capacity per MAHC 4.7.3.2.2.1 and 4.7.3.2.2.2.

4.7.3.2.2.3.1 Information Included This documentation shall include:

- 1) an evaluation of the DISINFECTION feeder/equipment based on the DESIGN PROFESSIONAL'S related professional experience, the DISINFECTION feeder/equipment manufacturer's recommendations, or other industry accepted guidelines in sizing the feeders/equipment and
- 2) a discussion of the analysis and use of the CHLORINE demand factors listed in MAHC 4.7.3.2.2.1 in sizing the feeders/equipment.

4.7.3.2.2.4 Upon Operation If upon operation it is determined that feeders/equipment are not capable of meeting the demand necessary to maintain minimum required DISINFECTION levels at all times, additional capacity shall be provided.

4.7.3.2.3 Introduction of Chemicals

4.7.3.2.3.1 Separation The injection point of DISINFECTION chemicals shall be located before any pH control chemical injection point with sufficient physical separation of the injection points to reduce the likelihood of mixing of these chemicals in the piping during periods of interruption of RECIRCULATION SYSTEM flow.

4.7.3.2.3.2 Backflow Means of injection shall not allow BACKFLOW into the chemical system from the POOL system.

4.7.3.2.3.3 Coagulants shall be metered and injected through a pump system prior to the filters per the manufacturer's recommended rate.

4.7.3.2.4 Compressed Chlorine Gas

4.7.3.2.4.1 Prohibited for New Construction Use of compressed CHLORINE gas shall be prohibited for new construction and after SUBSTANTIAL ALTERATION to existing AQUATIC FACILITIES.

4.7.3.2.5^A Types of Feeders

4.7.3.2.5.1 Liquid Solution Feeders Liquid solution feeders shall include positive displacement pumps such as peristaltic pumps, diaphragm pumps, and piston pumps.

4.7.3.2.5.1.1 Feed Rates Feed rates shall be locally adjusted on the pumps and also on/off controlled using an AUTOMATED CONTROLLER.

4.7.3.2.5.1.2 Routed All chemical tubing that runs through areas where staff work shall be

routed in PVC piping to support the tubing and/or otherwise supported and protected to prevent leaks.

4.7.3.2.5.1.3 **Size** The double containment PVC pipe shall be of sufficient size to allow for easy replacement of tubing.

4.7.3.2.5.1.4 **Turns** Any necessary turns in the piping shall be designed so as to prevent kinking of the tubing.

4.7.3.2.5.2 **Erosion** Erosion feeders may be pressure, pressure differential, or spray erosion types.

4.7.3.2.5.2.1 **Dry Chemical Feeders** Dry chemicals shall be granules or tablets.

4.7.3.2.5.2.2 **Located** Feeders shall have isolation valves on each side of the feeder to be closed before opening the unit.

4.7.3.2.5.2.3 **Source Water** Erosion feeders shall use AQUATIC VENUE water post-filtration as the source water unless approved by the feeder manufacturer.

4.7.3.2.5.3 **Gas Feed Systems** Carbon dioxide and ozone are the only gas feed systems permitted in AQUATIC FACILITIES.

4.7.3.2.5.4 **Ventilation** Proper ventilation shall be required for all gas systems.

4.7.3.2.5.5 **Alarms** Where CO₂ cylinders are located indoors, a monitor and alarm shall be provided to alert PATRONS/operator of high CO₂ and/or low O₂ levels.

4.7.3.2.5.6 **UV Systems** Where used, UV systems shall be installed in the RECIRCULATION SYSTEM after the filters.

4.7.3.2.5.6.1 **Bypass** A bypass pipe that is valved on both ends shall be installed to allow maintenance on the UV unit while the POOL is in operation.

4.7.3.2.5.6.2 **Interlock** UV system operation shall be interlocked with the recirculation pump so that power to the UV system is interrupted when there is no water flow to the UV unit per MAHC 4.7.3.2.1.3.

4.7.3.2.6 **Salt Electrolytic Chlorine Generators, Brine Electrolytic Chlorine, or Bromine Generators** Halogen generator equipment shall be marked with an EPA establishment number.

4.7.3.2.6.1 **Salt Electrolytic Chlorine Generators** In-line generator(s) or brine (*batch*) generator(s) shall be permitted on AQUATIC VENUES.

4.7.3.2.6.2 **In-line Method** In-line generators shall use POOL-grade salt dosed into the AQUATIC VENUE to produce and introduce CHLORINE into the AQUATIC VENUE treatment loop through an electrolytic chamber.

4.7.3.2.6.3 **Batch Method** Brine (*Batch*) generators shall produce CHLORINE through an electrolytic cell.

4.7.3.2.6.3.1 **Chlorine Production** CHLORINE shall be produced from brines composed of POOL-grade salt.

4.7.3.2.6.4 **TDS Readout** Electrolytic generators shall have a TDS or salt (*NaCl*) readout and a low salt indicator.

4.7.3.2.6.5 **Feed Rate** The feed rate shall be adjustable from zero (*0*) to full range.

4.7.3.2.6.6 **UL Standard** The generator unit shall be CERTIFIED, LISTED, AND LABELED to UL 1081 (*for electrical/fire/shock SAFETY*) by an ANSI-accredited certification organization.

4.7.3.2.6.7 **Interlock** The generator(s) shall be interlocked per MAHC 4.7.3.2.1.3.

4.7.3.2.6.8 **Installed** The generator units shall be installed according to the manufacturer's

instructions.

4.7.3.2.6.8.1 Saline Content The saline content of the POOL water shall be maintained in the required range specified by the manufacturer.

4.7.3.2.7^A Feeders for pH Adjustment

4.7.3.2.7.1 Provided Feeders for pH adjustment shall be provided on all AQUATIC VENUES upon adoption of this CODE as in MAHC 4.7.3.2.1.2.

4.7.3.2.7.2 Approved Substances Approved substances for pH adjustment shall include but not be limited to muriatic (*hydrochloric*) acid, sodium bisulfate, carbon dioxide, sulfuric acid, sodium bicarbonate, and soda ash.

4.7.3.2.7.3 Adjustable pH adjustment feeders shall be adjustable from zero (*0*) to full range.

4.7.3.2.7.4 Marked Reservoirs shall be clearly marked and labeled with contents.

4.7.3.2.8^A Automated Controllers

4.7.3.2.8.1 Required AUTOMATED CONTROLLERS shall be installed for MONITORING and turning on or off chemical feeders used for pH and disinfectants at all AQUATIC VENUES.

4.7.3.2.8.1.1 Existing Aquatic Facilities For existing AQUATIC FACILITIES, AUTOMATED CONTROLLERS shall be required within 1 year from adoption of this CODE.

4.7.3.2.8.2 NSF Standard All automated chemical controllers for pH and disinfectant MONITORING/control shall be CERTIFIED, LISTED, AND LABELED to NSF/ANSI 50 by an ANSI-accredited certification organization.

4.7.3.2.8.3 Operation Manuals Operation manuals or other instructions that give clear directions for cleaning and calibrating AUTOMATED CONTROLLER probes and sensors shall be provided in close proximity to the AUTOMATED CONTROLLER.

4.7.3.2.8.4 Set Point A set point shall be used to target the disinfectant concentration and the pH.

4.7.3.3 Secondary Treatment

4.7.3.3.1 General Requirements

4.7.3.3.1.1^A ANSI Listing and Labeling SECONDARY TREATMENT shall be CERTIFIED, LISTED, AND LABELED to ANSI/NSF 50 by an ANSI-accredited certification organization or approved by the AHJ with proper engineering justification.

4.7.3.3.1.1.1 Marked SECONDARY TREATMENT equipment shall be marked with an EPA establishment number.

4.7.3.3.1.2^A Required Facilities The new construction or SUBSTANTIAL ALTERATION of the following INCREASED RISK AQUATIC VENUES shall be required to use a SECONDARY TREATMENT after adoption of this CODE:

- 1) AQUATIC VENUES designed primarily for children under 5 years old, such as
 - a. Wading pools
 - b. INTERACTIVE WATER PLAY VENUES with no standing water, and
- 2) Therapy pools.

4.7.3.3.1.3 Other Aquatic Venues Optional SECONDARY TREATMENT may be installed on other AQUATIC VENUES not specified in MAHC 4.7.3.3.1.2.

4.7.3.3.1.4 Labeled If installed and labeled as SECONDARY TREATMENT, then they shall conform

to all requirements specified under MAHC 4.7.3.3.

4.7.3.3.1.5 Conform If not labeled as SECONDARY TREATMENT, then they shall be labeled as SUPPLEMENTAL TREATMENT systems and conform to requirements listed under MAHC 4.7.3.4.

4.7.3.3.2^A Log Inactivation and Oocyst Reduction

4.7.3.3.2.1^A Log Inactivation SECONDARY TREATMENT shall be designed to achieve a minimum 3-log (99.9%) reduction in the number of infective *Cryptosporidium* OOCYSTS per pass through the SECONDARY TREATMENT for INTERACTIVE WATER PLAY AQUATIC VENUES and a minimum 2-log (99%) reduction per pass for all other AQUATIC VENUES. Each SECONDARY TREATMENT may be composed of multiple treatment processes or steps that result in the total required reduction in the number of infective *Cryptosporidium* OOCYSTS per pass through the SECONDARY TREATMENT.

4.7.3.3.2.2^A Installation The SECONDARY TREATMENT shall be located in the treatment loop (*post filtration*) and treat a portion (*up to 100%*) of the filtration flow prior to return of the water to the AQUATIC VENUE or AQUATIC FEATURE, except on INTERACTIVE WATER PLAY AQUATIC VENUES. For INTERACTIVE WATER PLAY AQUATIC VENUES, the SECONDARY TREATMENT shall be located after the feature pump to treat 100% of the water prior to reaching the BATHERS.

4.7.3.3.2.3 Manufacturer's Instructions The SECONDARY TREATMENT shall be installed according to the manufacturer's directions.

4.7.3.3.2.4^A Minimum Flow Rate Calculation The flow rate (Q) through the SECONDARY TREATMENT shall be determined based upon the total volume of the AQUATIC VENUE or AQUATIC FEATURE (V) and a prescribed dilution time (T) for theoretically reducing the number of assumed infective *Cryptosporidium* OOCYSTS from an initial total number of 100 million (10^8) OOCYSTS to a concentration of one OOCYST/100 mL.

4.7.3.3.2.5^A Equation The SECONDARY TREATMENT flow rate (Q) shall be:

1) $Q = V \times \{[14.8 - \ln(V)] / (r \times 60 \times T)\}$, where:

- Q = SECONDARY TREATMENT flow rate (*GPM*)
- V = Total water volume of the AQUATIC VENUE or AQUATIC FEATURE, including surge tanks, piping, equipment, etc. (*gals*)
- r = Efficiency of the system ($r = 0.999$ for 3-log reduction, $r = 0.99$ for 2-log reduction)
- T = Dilution time (*hrs.*)

4.7.3.3.2.6 Time for Dilution Reduction The dilution time shall be the lesser of 9 hours or 75% of the uninterrupted time an AQUATIC VENUE is closed in a 24 hour period.

4.7.3.3.2.7^A Flow Rate Measurements Where a SECONDARY TREATMENT is installed, a means shall be installed to confirm the required flow rate to maintain a minimum required log inactivation of infective *Cryptosporidium* OOCYSTS at the minimum flow rate.

4.7.3.3.2.7.1 Flow Rate Defined The minimum required flow rate through the SECONDARY TREATMENT shall be as defined in MAHC 4.7.3.3.2.5.

4.7.3.3.3^A Ultraviolet Light Systems To prevent mercury exposure, UV systems shall be installed to avoid lamp breakage according to the guidelines in EPA 815-R-06-007 Appendix E.

4.7.3.3.3.1^A Third Party Validation UV equipment shall be third party validated in accordance with the practices outlined in the *EPA Ultraviolet Disinfectant Guidance Manual* dated November, 2006, publication number EPA 815-R-06-007 or, alternatively for UV equipment designed for INTERACTIVE WATER PLAY AQUATIC VENUES, in accordance with the practices for wastewater treatment equipment outlined in the Water Environment Federation/International Ultraviolet Association (WEF/IUVA) WEF/IUVA publication "Ultraviolet Disinfection for Wastewater" dated April 2015, ISBN: 978-1-57278-312-6.

4.7.3.3.3.1.1^A **Validation Standard** The *EPA Ultraviolet Disinfectant Guidance Manual* shall be considered a recognized national STANDARD in the MAHC.

4.7.3.3.3.2 **Suitable for Intended Use** UV systems and all materials used therein shall be suitable for their intended use and be installed:

- 1) In accordance with the MAHC;
- 2) As CERTIFIED, LISTED, AND LABELED to a specific STANDARD by an ANSI-accredited certification organization; and
- 3) As specified by the manufacturer.

4.7.3.3.3.3 **Installation** The UV equipment shall be installed after the filtration and before addition of primary disinfectant except on INTERACTIVE WATER PLAY AQUATIC VENUES. For INTERACTIVE WATER PLAY AQUATIC VENUES, the UV system shall be located after the feature pump to treat 100% of the water prior to reaching the BATHERS. When the features are off, the UV shall continue to circulate a minimum amount of water back through the tank, if required by the manufacturer for warm-up and cool-down purposes.

4.7.3.3.3.3.1 **Labeled** UV equipment shall be labeled with the following design specifications: maximum flow rate, minimum transmissivity, minimum intensity, and minimum dosage.

4.7.3.3.3.3.2 **Strainer Installation** An inline strainer shall be installed after the UV unit to capture broken lamp glass or sleeves.

4.7.3.3.3.4 **Electrically Interlocked** The equipment shall be electrically interlocked with feature pump(s) or automated feature supply valves, such that when the UV equipment fails to produce the required dosage as measured by automated sensor, the water features do not operate.

4.7.3.3.3.4.1^A **Alarm/Interlock Setpoint** The UV alarm/interlock setpoint shall be such that it ensures that the minimum required dose is delivered under all possible conditions of water UV transmittance and lamp output at the actual flow rate.

4.7.3.3.3.4.2 **Operation** UV systems shall not operate if the RECIRCULATION SYSTEM is not operating.

4.7.3.3.3.5 **Calibrated UV Sensors** The UV equipment shall be complete with calibrated UV sensors, which record the output of all the UV lamps installed in a system.

4.7.3.3.3.5.1 **Multiple Lamps** Where multiple lamps are fitted, sufficient sensors shall be provided to measure each lamp.

4.7.3.3.3.5.2 **Fewer Sensors** If the design utilizes fewer sensors than lamps, the location of lamps and sensors shall be such that the output of all lamps is adequately measured.

4.7.3.3.3.6 **Automated Shut Down** The automated shut down of the UV equipment for any reason shall initiate a visual alarm or other indication which will alert staff onsite or remotely.

4.7.3.3.3.6.1 **Signage** Signage instructing staff or PATRONS to notify facility management shall be posted adjacent to the visual indication.

4.7.3.3.3.6.2 **Not Staffed** If the AQUATIC FACILITY is not staffed, the sign shall include a means to contact management whenever the AQUATIC FACILITY is in use.

4.7.3.3.3.7 **Reports and Documentation** The UV equipment shall be supplied with the appropriate validation reports and documentation for that equipment model.

4.7.3.3.3.8 **Manufacturer Log Inactivation Chart** This documentation will include a graph or chart indicating the dose at which the required log inactivation is guaranteed for the system in question.

4.7.3.3.3.8.1 **Reduction Equivalent Dose Bias** This dose shall be inclusive of validation factors and RED BIAS.

4.7.3.3.3.8.2 System Performance Curves System performance curves that do not include such factors are not considered validated systems.

4.7.3.3.3.9^A Minimum RED Validation records shall include the graph indicating the minimum intensity reading required at the operational flow for the minimum RED required to achieve the required log reduction.

4.7.3.3.3.9.1 Minimum Intensity Shown Where systems are validated to a specific dose, the graph shall show the minimum intensity reading required at the operational flow for that dose.

4.7.3.3.3.10 Recommended Validation Protocol Based on the recommended validation protocol presented in the EPA Disinfection Guidance Manual, UV reactors certified by ÖNORM and DVGW for a *Bacillus subtilis* RED of 40mJ/cm² shall be granted 3-log *Cryptosporidium* and 3-log *Giardia* inactivation credit as required in this CODE provided that the AQUATIC VENUE's treated water UV TRANSMISSIVITY remains within the validated range of the UV system.

4.7.3.3.4 Ozone Disinfection

4.7.3.3.4.1^A Log Inactivation SECONDARY TREATMENT using ozone shall provide the required inactivation of *Cryptosporidium* in the full flow of the SECONDARY TREATMENT after any side-stream has remixed into the full flow of the SECONDARY TREATMENT.

4.7.3.3.4.2^A Onsite Measurement Ozone systems shall be designed to measure the concentration of ozone at a minimum of two sampling locations to determine the CT INACTIVATION VALUE achieved in the treatment system prior to return of the water to the AQUATIC VENUE or AQUATIC FEATURE recirculation treatment loop. A CT INACTIVATION VALUE of 4.9 ppm (mg/L)*min is required for 99% (2 -log) *Cryptosporidium* reduction at a water temperature of 77°F /25° C (or 7.4 ppm [mg/L]*min is required for 99.9% [3 -log] *Cryptosporidium* reduction at a water temperature of 77°F/25° C).

4.7.3.3.4.3^A Suitable for Use Ozone systems and all materials used therein shall be suitable for their intended use and be installed:

- 1) In accordance with all applicable requirements;
- 2) As CERTIFIED, LISTED, AND LABELED to a specific STANDARD by an ANSI-accredited certification organization; and
- 3) As specified by the manufacturer.

4.7.3.3.4.4 Ozone System Components An ozone system shall be a complete system consisting of the following (*either skid-mounted or components*):

- 1) Ozone generator;
- 2) Injector / injector manifold;
- 3) Reaction tank (*contact tank*) / mixing tank / degas tower;
- 4) Degas valve (*if applicable, to vent un-dissolved gaseous ozone*);
- 5) Ozone destruct (*to destroy un-dissolved gaseous ozone*);
- 6) ORP monitor / controller;
- 7) Ambient ozone monitor / controller;
- 8) Air flow meter / controller; and
- 9) Water BACKFLOW prevention device in gas delivery system.

4.7.3.3.4.5 Appropriate Installation These components (*or skid*) shall be installed as specified by the manufacturer to maintain the required system validation as noted above.

4.7.3.3.4.6 ORP Monitor The ozone generating equipment shall be designed, sized, and

controlled utilizing an ORP monitor / controller (*independent of and in addition to any halogen ORP monitor/controller*).

4.7.3.3.4.6.1 Placed Downstream The device shall be placed in the AQUATIC VENUE and AQUATIC FEATURE recirculation water downstream of the ozone side-stream loop and before the halogen feed location.

4.7.3.3.4.6.2 Minimum ORP Reading The minimum ORP reading shall be no less than 600 mV measured directly after [*one to 5 feet (30.5 cm to 1.5 m)*] the ozone side-stream remixes into the full flow of the RECIRCULATION SYSTEM.

4.7.3.3.4.6.3 Maximum ORP Reading The maximum ORP reading shall be no greater than 900 mV.

4.7.3.3.4.7 Installation and Injection Point The ozone system injection point shall be located in the AQUATIC VENUE return line after the filtration and heating equipment, prior to the primary disinfectant injection point.

4.7.3.3.4.7.1 Injection and Mixing The injection and mixing system shall not prevent the attainment of the recirculation rate required elsewhere in this CODE.

4.7.3.3.4.7.2^A Gas Monitor / Controller An ambient ozone gas monitor/controller located adjacent to the ozone reactor/contact tank shall be utilized to disable the ozone system in the event of an ozone gas leak.

4.7.3.3.4.8 Comply with Fire Code Ozone system installations shall comply with the NFPA 1 Fire Code or the International Fire Code and any other CODES, STANDARDS, or requirements as mandated by the AHJ.

4.7.3.3.4.9 Air Space Testing At the time the ozone generating equipment is installed, again after 24 hours of operation, and annually thereafter, the air space within 6 inches of the AQUATIC VENUE water shall be tested to determine compliance of less than 0.1 ppm (*mg/L*) gaseous ozone.

4.7.3.3.4.9.1 Results Results of the test shall be maintained onsite for review by the AHJ.

4.7.3.3.4.10 Automatic Shut Down Automatic shutdown shall occur under any condition that would result in the ozone system not operating within the established parameters needed to achieve the required log inactivation of *Cryptosporidium* (*i.e., low feed gas supply, loss of vacuum or pressure, high dew point in feed air, water in ozone gas delivery line*).

4.7.3.3.4.10.1 Electrically Interlocked The equipment shall be electrically interlocked with AQUATIC VENUE pump(s) or automated feature supply valves, such that when the ozone equipment fails to produce the required dosage as measured by ORP, the AQUATIC VENUES do not operate.

4.7.3.3.4.11 ORP Reading Alarm or Visual Indication If the ORP reading for the ozone system drops below 600 mV (*regardless of the cause*) a visual alarm or other indication shall be initiated that will alert staff onsite or remotely.

4.7.3.3.4.11.1 Signage Signage to notify facility management shall be present adjacent to the visual alarm.

4.7.3.3.4.12 Regular Audits In order to ensure that the supplied ozone system meets all the requirements of the STANDARD, the manufacturer shall maintain a quality system audited on a regular basis to a recognized quality STANDARD.

4.7.3.3.4.12.1 Listed Ozone equipment shall be listed to NSF/ANSI 50.

4.7.3.3.4.13 Reports and Documentation The ozone system shall be supplied with the appropriate validation reports and documentation for that equipment model.

4.7.3.3.4.13.1 Log Inactivation Chart Ozone validation reports shall include a graph, chart, or other documentation which clearly indicates the required operating parameters for which the required

log inactivation is guaranteed for the system in question.

4.7.3.3.4.13.2 **Inclusive** This dose shall be inclusive of validation factors.

4.7.3.3.4.13.3 **System Performance Curves** System performance curves that do not include such factors are not considered validated systems.

4.7.3.3.5 Filtration Removal of *Cryptosporidium* oocysts Filtration systems to be used in SECONDARY TREATMENT for *Cryptosporidium* reduction in INCREASED RISK AQUATIC VENUES shall be certified by at least one of the following methods:

- 1) NSF Certified to confirm that they provide the specified log reduction of *Cryptosporidium* OOCYSTS or a conservative surrogate using realistic AQUATIC VENUE water quality values and operating conditions.
- 2) ANSI-accredited third-party testing and certification organization confirmation that they provide the specified log reduction of *Cryptosporidium* OOCYSTS or a conservative surrogate using realistic AQUATIC VENUE water quality values and operating conditions.
- 3) Peer-reviewed literature values with specified log reduction of *Cryptosporidium* OOCYSTS or a conservative surrogate using realistic AQUATIC VENUE water quality values and operating conditions.

4.7.3.4 Supplemental Treatment Systems

4.7.3.4.1 General Requirements

4.7.3.4.1.1^A **Optional** AQUATIC VENUES that do not require SECONDARY TREATMENT may install SUPPLEMENTAL TREATMENT systems for the purpose of enhancing overall system performance and improving water quality.

4.7.3.4.1.2 **Clearly Noted** The AQUATIC FACILITY operating instructions shall clearly note that these SUPPLEMENTAL TREATMENT SYSTEMS do not meet the requirements of a SECONDARY TREATMENT, and as such, are only considered SUPPLEMENTAL TREATMENT SYSTEMS.

4.7.3.4.1.3 **No Log Inactivation Required** SUPPLEMENTAL TREATMENT SYSTEMS shall meet all of the requirements of this CODE, except:

- 1) They do not need to achieve the minimum log inactivation of *Cryptosporidium parvum* as required in MAHC 4.7.3.3;
- 2) They do not need to be able to reduce the total number of infective OOCYSTS to one OOCYST per 100 mL as required in MAHC 4.7.3.3; and
- 3) Except as noted in MAHC 4.7.3.4.2 and 4.7.3.4.3 below.

4.7.3.4.1.4 **Clearly Labeled** Each system shall be clearly labeled, “Supplemental Water Treatment System—Does Not meet the requirements for Secondary Disinfection.”

4.7.3.4.2^A Ultraviolet Light

4.7.3.4.2.1 **UV as Supplemental Treatment Requirement** When UV is used as a SUPPLEMENTAL TREATMENT system, all requirements of MAHC 4.7.3.3.3.2 through 4.7.3.3.3.4 shall be met.

4.7.3.4.2.3 **Water Features** Water features shall not require shut off if the supplemental UV system does not produce the required dosage.

4.7.3.4.2.4 **Exempt** The equipment is exempt from the validation requirements of MAHC 4.7.3.3.3.1.

4.7.3.4.3^A Ozone

4.7.3.4.3.1 **Ozone as Supplemental Treatment Requirement** When ozone is used as a SUPPLEMENTAL TREATMENT system, all requirements of MAHC 4.7.3.3.4.3 thru 4.7.3.3.4.9 shall be met.

4.7.3.4.3.2 **Maximum ORP Reading** The maximum ORP reading shall be no greater than 900 mV.

4.7.3.4.4^A **Copper / Silver Ion Systems**

4.7.3.4.4.1 Only EPA-REGISTERED Disinfectants Only those systems that are EPA REGISTERED for use as disinfectants in AQUATIC VENUES or SPAS in the United States shall be permitted.

4.7.3.4.4.2 Suitable Copper/silver systems, and all materials used therein, shall be suitable for their intended use.

4.7.3.4.4.3 Installed Copper/silver systems, and all materials used therein, shall be installed in accordance with all applicable requirements and manufacturer's instructions.

4.7.3.4.5^A Ultraviolet Light / Hydrogen Peroxide Systems UV light / hydrogen peroxide combination systems shall be prohibited for use in aquatic facilities.

4.7.3.5^A **Water Quality Testing Devices and Kits**

4.7.3.5.1 Compliance WQTDs and kits shall be CERTIFIED, LISTED, AND LABELED to NSF/ANSI 50 by an ANSI-accredited certification organization.

4.7.3.5.2 Water Clarity Device Refer to MAHC 5.7.6 for guidance on water clarity devices.

4.7.3.6^A **Microbiological Testing Equipment**

4.7.3.6.1 EPA Approved Microbiological testing equipment and methods shall be:

- 1) EPA Approved, EPA Accepted, EPA Equivalent;
- 2) Conforming to the latest edition of *Standard Methods for the Examination of Water and Wastewater*; or
- 3) CERTIFIED, LISTED, AND LABELED to NSF/ANSI 50 by an ANSI-accredited certification organization.

4.7.4^A **Water Replenishment System**

4.7.4.1^A Discharge and Measure A WATER REPLENISHMENT SYSTEM consisting of a means to intentionally discharge and measure or calculate the volume of both discharged AQUATIC VENUE water and filter backwash wastewater (or alternate means of achieving the same result) shall be provided.

4.7.4.1.1^A Alternate System An alternate system capable of removing an equivalent amount of turbidity, total dissolved organic carbon (TOC), and total nitrogen (TN) containing compounds shall also be acceptable in lieu of discharging AQUATIC VENUE water.

4.7.4.1.1.1 Product Water When an alternate system is used, the return water from the alternate system shall maintain turbidity, total organic carbon, and total nitrogen concentrations that are less than or equal to the AQUATIC VENUE water supply.

4.7.4.1.2 Discharge The WATER REPLENISHMENT SYSTEM shall be designed to discharge (or treat and reuse via a separate treatment system capable of removing compounds specified in MAHC 4.7.4.1.1) AQUATIC VENUE water at a rate of at least 4 gallons (15 L) per BATHER per day per AQUATIC VENUE.

4.7.5 **Spas**

4.7.5.1^A **General**

4.7.5.1.1 Requirements SPAS shall conform to the design, operation, and maintenance requirement of AQUATIC VENUES except as required below.

4.7.5.2 **Flow Rates/Turnover Times**

4.7.5.2.1 Maximum Allowable All SPAS shall be designed to have a maximum allowable TURNOVER TIME of 0.5 hour or less.

4.7.5.2.2 Turnover Times TURNOVER TIMES shall be calculated based solely on the flow rate through the filtration system.

4.7.5.3 Filtration System Inlets SPAS shall have a minimum of two adjustable filter system INLETS located below the surface of the UNDERWATER BENCH and spaced at least 3 feet (*0.9 m*) apart and designed to distribute flow evenly.

4.7.5.4 Hydrotherapy Jet System Inlets

4.7.5.4.1 Air Flow Air flow shall be permitted through the hydrotherapy jet system and/or when injected post-filtration.

4.7.5.4.2 Skimmer Submerged suction SKIMMERS shall be allowed provided that the manufacturer's recommendations for use are followed.

4.7.5.4.3 Independent The hydrotherapy jet system shall be independent of the recirculation, filtration, and heating systems.

4.8 Decks and Equipment

4.8.1 Decks

4.8.1.1 General Standards for All Decks

4.8.1.1.1^A Lifeguard Placement and Safety Considerations DECKS shall be designed to allow for QUALIFIED LIFEGUARD placement per the zone of BATHER surveillance in MAHC 6.3.3.1.1 and safety areas and equipment in MAHC 4.8.5.

4.8.1.1.1.1^A Deck Clearance DECKS shall have a minimum of 4 feet (*1.2 m*) of clearance from AQUATIC VENUE edge to fencing or other obstruction to allow for QUALIFIED LIFEGUARD transit, roaming, or change of positioning to maximize viewing of the zone of BATHER surveillance as well as execution of water extrication.

4.8.1.1.1.2^A Access Points Access points shall be provided to QUALIFIED LIFEGUARDS to transit to QUALIFIED LIFEGUARDS positions.

4.8.1.1.1.3^A Bather Zone Surveillance The designer and owner shall consider impact on BATHER zone surveillance when determining placement of structural, operational, and theming elements.

4.8.1.1.1.3.1 Elements for Deck Placement These elements shall include but are not limited to chairs, fencing, ADA access equipment, and AQUATIC FEATURES.

4.8.1.1.2 Joints or Gaps Conditions between adjacent DECK materials, components, and concrete pours shall not have horizontal open joints or gaps larger than 3/16 inches wide (*4.8 mm*).

4.8.1.1.2.1 Vertical Elevation Any change in vertical elevation between adjacent DECK materials, components, and concrete pours exceed $\frac{1}{4}$ inches (*6.4 mm*) shall be considered an edge condition and shall be treated according to MAHC 4.8.1.1.2.2 or MAHC 4.8.1.1.3.

4.8.1.1.2.2 Fillers Open joints or gaps larger than 3/16 inches (*4.8 mm*) wide or with vertical elevations exceeding $\frac{1}{4}$ inches (*6.4 mm*) shall be rectified using appropriate fillers.

4.8.1.1.2.3 Sealants The use of fillers such as caulk or sealant in joints or gaps shall be permitted for expansion and contraction.

4.8.1.1.2.4 No Violation The use of fillers such as caulk or sealant in joints or gaps shall not be in violation of MAHC 4.8.1.1.3.

4.8.1.1.3 Rounded Edges All DECK edges shall be beveled, rounded, or otherwise relieved to eliminate sharp corners.

4.8.1.1.4 Minimize Cracks Joints in DECKING shall be provided to minimize the potential for CRACKS due to a change in elevation, for movement of the slab and for shrinkage control.

4.8.1.1.5^A Concrete Decking Where concrete is used as a DECK material, it shall be installed in accordance with the latest edition of the American Concrete Institute (*ACI*) Standards and in accordance with applicable local, state, territorial, federal, and tribal building CODES.

4.8.1.1.6 Access Hatches Any access hatches located within the surface of the DECK shall be lockable, SLIP RESISTANT, and designed to maintain acceptable surface temperatures to allow barefoot traffic.

4.8.1.2^A Standards for Perimeter Decks

4.8.1.2.1 Impervious Finish materials for the PERIMETER DECK shall be suitable for the POOL environment, non-toxic, and substantially impervious.

4.8.1.2.2 Watertight Expansion Continuous watertight EXPANSION JOINT material shall be provided between PERIMETER DECKS and POOL coping.

4.8.1.2.2.1 Expansion Joint Where applicable, the EXPANSION JOINT shall be designed and constructed so as to protect the coping and its mortar bed from damage as a result of movement of adjoining DECK.

4.8.1.2.3 Watertight Expansion All conditions between adjacent concrete PERIMETER DECK pours shall be constructed with watertight EXPANSION JOINTS.

4.8.1.2.3.1 Joint Measurements Joints shall be at least 3/16 inches (*5 mm*) in continuous width.

4.8.1.2.3.2 Vertical Differential The maximum allowable vertical differential across a joint shall be ¼ inches (*6.5 mm*).

4.8.1.3 Drains Refer to MAHC 4.11.4 for additional guidance on drains.

4.8.1.3.1^A Slope DECKS shall be sloped away from the AQUATIC VENUE and in accordance with MAHC Table 4.8.1.3 below.

Table 4.8.1.3 Minimum Slopes for Drainage

Surface	Minimum Slope
Smooth finishes; such as tile, hand-finished concrete & lightly-broomed concrete	1/8 inch per foot (3.2 mm/30.5 cm)
Moderately textured finishes; such as exposed aggregate or medium-broomed concrete	1/4 inch per foot (6.4 mm/30.5 cm)
Heavily textured finishes; such as brick (where permitted)	3/8 inch per foot (9.5 mm/30.5 cm)

4.8.1.3.1.1 Accessible Routes Where DECK areas or portions thereof serve as ACCESSIBLE ROUTES, slopes in any direction shall not exceed ADA requirements.

4.8.1.3.1.2 All Water All water that touches areas defined as DECK, including water originating in the AQUATIC VENUE, shall drain effectively to either perimeter areas or to DECK drains.

4.8.1.3.1.3 Remove Wastewater Drainage shall remove AQUATIC VENUE water that splashes outside of the AQUATIC VENUE and beyond a POOL gutter system, DECK cleaning water, and rain water without leaving standing water.

4.8.1.3.2 Placement The placement of DECK drains, where provided, shall effectively carry water away from the AQUATIC VENUE and off the DECK without ponding.

4.8.1.3.3^A Cross-Connection Control There shall be no direct connection between the DECK drains and the sanitary or storm sewer system.

4.8.1.3.3.1 Discharge to Sewer or Other Ground Water If the AHJ requires an outdoor POOL to have DECK drains that discharge to a storm sewer system, ground surface, or holding pond, the POOL shall be plumbed through an air-gap, BACKFLOW preventer, or other approved device as allowed by the AHJ.

4.8.1.3.3.2^A No Drain DECK drains shall not drain to the POOL, POOL gutter, or RECIRCULATION SYSTEMS.

4.8.1.3.4 Drain Bodies Drain receptacles shall consist of non-corrosive or corrosion-resistant materials.

4.8.1.3.5 Drain Covers Drain covers shall be suitable for bare foot traffic with openings no greater than ½ inch (1.3 cm) and easily removable with a simple tool to facilitate regular cleaning.

4.8.1.4 Materials / Slip Resistant

4.8.1.4.1 General PERIMETER DECK and POOL DECK shall be constructed with a uniform and easily cleaned surface such as concrete, tile, manufactured or acrylic surfaces.

4.8.1.4.2^A Slip Resistant All DECKS shall have SLIP-RESISTANT, textured finishes, which are not conducive to slipping under contact of bare feet in wet or dry conditions.

4.8.1.4.3^A Carpet Carpet and artificial turf shall be prohibited materials for PERIMETER DECK and POOL DECK.

4.8.1.4.4^A Wood Wood shall be a prohibited material for use as PERIMETER DECK.

4.8.1.4.5^A Dry Deck DRY DECK shall be easily maintained and not create a public health hazard.

4.8.1.4.5.1 Not Required DRY DECK shall not be required to be hard-paved or impervious.

4.8.1.4.5.2 Wood Decking Wood DECKING may be permitted for DRY DECK.

4.8.1.4.6^A Landscaping Loose plant material or bedding shall not be permitted within PERIMETER DECKS.

4.8.1.4.6.1 Stable Materials Stable materials are permitted.

4.8.1.5^A Deck Size / Width

4.8.1.5.1 Perimeter Deck

4.8.1.5.1.1^A Width PERIMETER DECKS shall be 4 feet (1.2 m) minimum in unobstructed width around the POOL perimeter as prescribed in this section.

4.8.1.5.1.1.1 Circulation Path Perimeter DECK may serve as part of the CIRCULATION PATH.

4.8.1.5.1.1.2 Flush with Pool Wall PERIMETER DECK areas shall be flush with POOL walls/copings except where special conditions exist, such as elevated beam or parapet, raised transfer walls, or as permitted by other sections of this CODE.

4.8.1.5.1.2^A Perimeter Decking PERIMETER DECKS shall be provided around 100% of the AQUATIC VENUE perimeter except where special conditions exist as permitted by other sections of this CODE.

4.8.1.5.1.3^A Unguarded Aquatic Venues For unguarded POOLS, PERIMETER DECKS shall be provided in compliance with at least one of two options:

- 1) Provide PERIMETER DECK around 100% of the of the POOL perimeter or
- 2) Provide PERIMETER DECK such that the entire perimeter and depth of the POOL is readily reachable by a pole and hook from the PERIMETER DECK.

4.8.1.5.1.4 Spectator Seating Refer to MAHC 4.6.10 for more information on spectator areas.

4.8.1.5.2 *Fixed Equipment*

4.8.1.5.2.1 **Unobstructed Deck** Unobstructed DECK area 4 feet (1.2 m) minimum in width shall be provided for access around:

- 1) Diving equipment,
- 2) Special feature stairways (*such as a WATERSLIDE*),
- 3) Lifeguard stands,
- 4) Diving boards,
- 5) Similar DECK equipment,
- 6) ADA access equipment, and
- 7) Structural columns.

4.8.1.5.2.2 **Circulation Path** This unobstructed area may overlap the CIRCULATION PATH.

4.8.1.5.2.3 **Queuing Space** Where reasonably anticipated, queuing space shall be provided at applicable equipment to minimize encroachment into the CIRCULATION PATH.

4.8.1.5.2.4 **Free Space** Free area around equipment may consist of PERIMETER DECK and/or POOL DECK, as applicable.

4.8.1.5.3 *Circulation Path*

4.8.1.5.3.1 **Conformance** A continuous and unobstructed CIRCULATION PATH shall be provided in conformance with ADA requirements for an ACCESSIBLE ROUTE.

4.8.1.5.3.2 **Equipment and Furniture** DECK furniture locations shall be designed not to intrude upon any CIRCULATION PATH.

4.8.1.5.3.3 **Connect** CIRCULATION PATHS shall connect all site amenities, entrances, and exits as required by ADA.

4.8.1.5.3.4 **Deck Types** CIRCULATION PATHS may consist of any combination of permitted DECK types.

4.8.1.6 *Wing Walls or Peninsulas*

4.8.1.6.1^A **No Perimeter Deck** WING WALLS or PENINSULAS less than 18 inches (45.7 cm) in width shall not be considered a part of the PERIMETER DECK.

4.8.1.6.1.1 **Use by Lifeguards** A WING WALL or PENINSULA greater than 18 inches (45.7 cm) wide but less than 48 inches (1.2 m) wide may be used by QUALIFIED LIFEGUARD personnel but shall not be considered as part of the PERIMETER DECK.

4.8.1.6.1.2 **Slip Resistant** Any WING WALL or PENINSULA shall be constructed of SLIP-RESISTANT materials.

4.8.1.6.2^A **Perimeter Overflow System** If it is impractical to design a perimeter overflow system into the WING WALL or PENINSULA due to width or height, then the overflow system may bypass the WING WALL or PENINSULA.

4.8.1.6.3^A **Pool Perimeter** WING WALLS and PENINSULAS shall be considered part of the POOL.

4.8.1.6.3.1 **Calculating** WING WALLS and PENINSULAS shall not be accounted for in calculating the POOL perimeter.

4.8.1.6.4 **Normal Operating Water Level** WING WALLS and PENINSULAS shall be at or above the normal operating water level of the POOL.

4.8.1.6.5^A **Deck Drainage** DECK drainage shall not be required for WING WALLS or PENINSULAS as they are considered part of the POOL.

4.8.1.6.5.1 **Crowned** The tops shall be crowned to prevent standing water and sloped to the POOL or overflow system.

4.8.1.6.6 **Vertical Depth Markers** Vertical depth markers shall be provided around WING WALLS and PENINSULAS in accordance with MAHC 4.5.19.

4.8.1.7^A **Islands**

4.8.1.7.1 **Minimum Width** An ISLAND not more than 18 inches (45.7 cm) in width shall be designed to discourage a person from walking on the ISLAND by not providing stairs, ladders, or bridges to the ISLAND.

4.8.1.7.2 **Slip Resistant** The surface of ISLANDS shall be SLIP RESISTANT.

4.8.1.7.3 **Lifeguards** An ISLAND 18 inches (45.7 cm) to 48 inches (1.2 m) wide may be allowed for use only by QUALIFIED LIFEGUARDS.

4.8.1.7.4 **Vertical Depth Markers** Vertical depth markers shall be provided around ISLANDS in accordance with MAHC 4.5.19 and visible from all sides.

4.8.1.7.5 **Horizontal Depth Markers** Horizontal depth markings and warning signs shall also be required per MAHC 4.5.19 if the ISLAND is designed for BATHER use.

4.8.1.7.5.1 **Island Not Intended for Bather Use** If the ISLAND is not designed for BATHER use, warning signs stating “No Entry” shall be required.

4.8.1.7.6 **Bridge or Stairway** An ISLAND designed for BATHER traffic shall be accessible by bridge, ramp, ladder, or stairway from the POOL.

4.8.1.7.7 **Minimum Clearance** All bridges spanning a POOL or any other structures not intended for INTERACTIVE PLAY shall have a minimum clearance of 7 feet (2.1 m) from the bottom of the POOL to any structure overhead.

4.8.1.7.8 **Guard Rails** Any bridge shall have a minimum 42 inch (1.1 m) high BARRIER on both sides.

4.8.1.8^A **Heated Decks**

4.8.1.8.1 **Freeze Protection** Where heated DECKS are provided for the purpose of freeze protection, the extent of heated area shall minimally include the entire required PERIMETER DECK and required CIRCULATION PATH(s).

4.8.1.8.2 **Clearly Delineated** Heated DECK paths shall be clearly delineated with respect to unheated DECKS.

4.8.1.9 **Hose Bibbs**

4.8.1.9.1 **General** Domestic water hose bibbs shall be provided in sufficient quantity, spacing, and type to wash down PERIMETER DECK and POOL DECK areas using a hose of no longer than 100 feet (30.5 m).

4.8.1.9.2 **Backflow Prevention** All hose bibbs shall be equipped with BACKFLOW prevention devices.

4.8.2 **Diving Boards and Platforms**

4.8.2.1^A **Diving Envelope**

4.8.2.1.1^A **Competitive Diving** Diving boards shall be permitted only when the diving envelope conforms to the most current version of STANDARDS referenced in MAHC Chapter 3 for the certifying agency

that regulates competitive diving at the AQUATIC FACILITY. Such certifying agencies include:

- 1) NCAA,
- 2) NFHS,
- 3) FINA, or
- 4) U.S.A. Diving, Inc.

4.8.2.1.2^A Non-Competitive Diving If the AQUATIC VENUE does not have competitive diving, then the diving envelope shall conform to the diving envelope STANDARDS of:

- 1) MAHC Table 4.8.2.2,
- 2) MAHC Table 4.8.2.3,
- 3) MAHC Figure 4.8.2.2.1, and
- 4) MAHC Figure 4.8.2.2.2.

4.8.2.2^A Steps and Guardrails

4.8.2.2.1 Higher than Twenty-One Inches Diving stands higher than 21 inches (53.3 cm) measured from the DECK to the top of the butt end of the board or platform shall have steps or a ladder and handrails.

4.8.2.2.2 Self-Draining Treads Steps or ladder treads shall be self-draining, corrosion resistant, SLIP RESISTANT, and designed to support the maximum expected load.

4.8.2.2.3 Short Platforms Diving stands or platforms that are 1 meter (3.4 ft) or higher shall be protected with guard rails at least 30 inches (76.2 cm) above the board, extending at least to the edge of the water along with intermediate rails.

4.8.2.2.4^A Tall Platforms Diving stands or platforms that are 2 meters (6.6 ft) or higher shall have guard rails with the top rail at least 36 inches (0.9 m) above the board and a second rail approximately half the distance from the platform to the upper rail.

Table 4.8.2.2: Diving Board Height and Dimensions

Diving Board Height	1.64 ft. (0.5 m)	2.46 ft. (0.75 m)	3.28 ft. (1.0 m)	3.84 ft. (3.0 m)
Diving Board Length	10.0 ft. (3.05 m)	12.0 ft. (3.66 m)	16.0 ft. (4.88 m)	16.0 ft. (4.88 m)
Diving Board Width	20.0 in. (50.8 cm)	20.0 in. (50.8 cm)	20.0 in. (50.8 cm)	20.0 in. (50.8 cm)

Table 4.8.2.3: Minimum Dimensions of Components Related to Diving Wells By Diving Board Height

Note: Letters below refer to MAHC Figures 4.8.2.2.1 & 4.8.2.2.2

		Minimum Dimensions			
Diving Board Height		0.5 Meter	0.75 Meter	1.0 Meter	3.0 Meter
A	Distance from plummet back to pool wall	3.0 ft. <i>(0.91 m)</i>	4.5 ft. <i>(1.37 m)</i>	6.0 ft. <i>(1.83 m)</i>	6.0 ft. <i>(1.83 m)</i>
B	Distance from plummet to pool wall at side	10.0 ft. <i>(3.05 m)</i>	10.0 ft. <i>(3.05 m)</i>	10.0 ft. <i>(3.05 m)</i>	11.5 ft. <i>(3.51 m)</i>
C	Distance from plummet to adjacent plummet	8.83 ft. <i>(2.69 m)</i>	8.83 ft. <i>(2.69 m)</i>	8.83 ft. <i>(2.69 m)</i>	8.54 ft. <i>(2.60 m)</i>
D	Distance from plummet to pool wall ahead	26.0 ft. <i>(7.92 m)</i>	27.83 ft. <i>(8.48 m)</i>	29.58 ft. <i>(9.02 m)</i>	33.67 ft. <i>(10.26 m)</i>
E	Height, diving board to ceiling at plummet & distances F and G	16.0 ft. <i>(4.88 m)</i>	16.0 ft. <i>(4.88 m)</i>	16.0 ft. <i>(4.88 m)</i>	16.0 ft. <i>(4.88 m)</i>
F	Clear overhead distance behind and each side of plummet	8.0 ft. <i>(2.34 m)</i>	8.0 ft. <i>(2.34 m)</i>	8.0 ft. <i>(2.34 m)</i>	8.0 ft. <i>(2.34 m)</i>
G	Clear overhead distance ahead of plummet	16.0 ft. <i>(4.88 m)</i>	16.0 ft. <i>(4.88 m)</i>	16.0 ft. <i>(4.88 m)</i>	16.0 ft. <i>(4.88 m)</i>
H	Depth of water at plummet	9.5 ft. <i>(2.90 m)</i>	10.75 ft. <i>(3.28 m)</i>	12.0 ft. <i>(3.66 m)</i>	12.5 ft. <i>(3.81 m)</i>
J	Distance ahead of plummet to depth K	12.0 ft. <i>(3.66 m)</i>	14.25 ft. <i>(4.34 m)</i>	16.5 ft. <i>(5.03 m)</i>	19.75 ft. <i>(6.02 m)</i>
K	Depth at distance J ahead of plummet	8.75 ft. <i>(2.67 m)</i>	10.0 ft. <i>(3.05 m)</i>	11.28 ft. <i>(3.44 m)</i>	12.17 ft. <i>(3.71 m)</i>
L	Distance at each side of plummet to depth M	8.0 ft. <i>(2.34 m)</i>	8.13 ft. <i>(2.48 m)</i>	8.25 ft. <i>(2.51 m)</i>	9.92 ft. <i>(3.02 m)</i>
M	Depth at distance L on each side of plummet	9.08 ft. <i>(2.77 m)</i>	10.33 ft. <i>(3.15 m)</i>	11.63 ft. <i>(3.54 m)</i>	12.17 ft. <i>(3.71 m)</i>
N	Maximum slope to reduce height E	30°	30°	30°	30°
P	Maximum floor slope to reduce depth ahead of K, to the sides of M, or back to pool wall behind H	3:1	3:1	3:1	3:1

Figure 4.8.2.2.1: Diving Platform Longitudinal Section: Side View

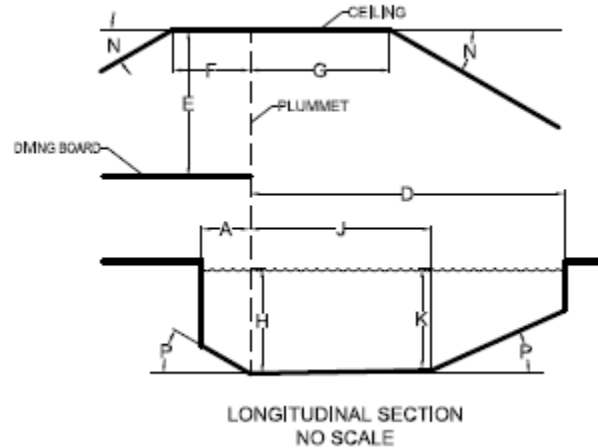
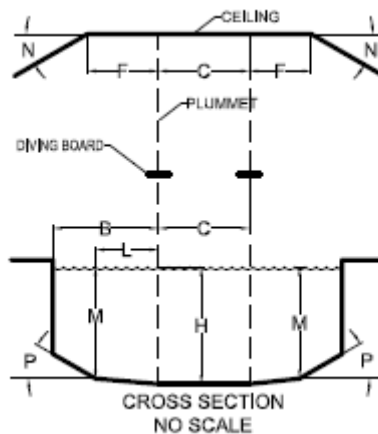

Figure 4.8.2.2.2: Diving Platform Cross Section: Front View



4.8.3 Starting Platforms

4.8.3.1^A Conform to Standard Codes Starting platforms shall be installed and conform to applicable SAFETY STANDARDS established by:

- 1) FINA,
- 2) U.S.A. Swimming,
- 3) NCAA,
- 4) NFHS,
- 5) YMCA, or
- 6) Other sanctioning body.

4.8.3.2 Minimum Water Depth Starting platforms shall be installed in a minimum water depth of 4 feet (1.25 m), except for new construction, where starting platforms shall be installed in a minimum water depth of 6 feet (1.8 m).

4.8.3.3 Leading Edge The leading edge of starting platforms shall have a maximum height of 30 inches (76.2 cm) above the water surface.

4.8.3.4 Slip Resistant Starting platforms shall have SLIP-RESISTANT tread surfaces.

4.8.3.5 Secure and Stable Starting platforms shall be installed and secured per manufacturer's

recommendations at all times when in use.

4.8.4 Pool Slides [N/A]

4.8.5 Lifeguard- & Safety-Related Equipment

4.8.5.1 Equipment Inspection and Maintenance [N/A]

4.8.5.2 Safety Equipment Required at all Aquatic Facilities

4.8.5.2.1^A Emergency Communication Equipment The AQUATIC FACILITY or each AQUATIC VENUE, as necessary, shall have a functional telephone or other communication device that is hard wired and capable of directly dialing 911 or function as the emergency notification system.

4.8.5.2.1.1 Conspicuous and Accessible The telephone or communication system or device shall be conspicuously provided and accessible to AQUATIC VENUE users such that it can be reached immediately.

4.8.5.2.1.2 Alternate Communication Systems Alternate systems, devices, or communication processes are allowed with approval of the AHJ in situations when a telephone is not logistically sound, and an alternate means of communication is available, which meet the requirements of MAHC 5.8.5.2.1.2.

4.8.5.2.1.3 Internal Communication The AQUATIC FACILITY design shall include a method for staff to communicate in cases of emergency.

4.8.5.2.1.4 Signage A sign shall be posted at the telephone providing dialing instructions, address and location of the AQUATIC VENUE location, and the telephone number.

4.8.5.3 Safety Equipment Required at Facilities with Lifeguards

4.8.5.3.1^A Lifeguard Chair and Stand Placement The designer shall coordinate with the owner and/or an aquatic consultant to consider the impact on BATHER surveillance zones for placement of chairs and stands designed to be permanently installed so as to provide an unobstructed view of the BATHER surveillance zones.

4.8.5.3.2^A Lifeguard Chair and Stand Design The chairs/stands shall be designed:

- 1) With no sharp edges or protrusions;
- 2) With sturdy, durable, and UV-resistant materials;
- 3) To provide enough height to elevate the lifeguard to an eye level above the heads of the BATHERS; and
- 4) To provide safe access and egress for the lifeguard.

4.8.5.3.3^A UV Protection for Chairs and Stands Where provided, permanently installed chairs/stands, where QUALIFIED LIFEGUARDS can be exposed to UV radiation, shall include protection from such UV radiation exposure.

4.8.6 Barriers and Enclosures

4.8.6.1^A General Requirements

4.8.6.1.1 Enclosure All AQUATIC FACILITIES, CHEMICAL STORAGE SPACES, and AQUATIC VENUE mechanical spaces shall be located in an ENCLOSURE to prevent unauthorized entry.

4.8.6.1.1.1 Enclosures The ENCLOSURE may consist of any combination of building envelopes, site walls, or fencing as provided for in this section.

4.8.6.1.1.2 Patron Accessibility An ENCLOSURE shall be provided between CHEMICAL STORAGE SPACES, POOL, mechanical spaces, and areas accessible to the public, in accordance with applicable local, state, territorial, federal, and tribal building CODES.

4.8.6.2 Construction Requirements

4.8.6.2.1^A Discourage Climbing ENCLOSURES shall be designed to discourage climbing and be located at an AQUATIC VENUE or an AQUATIC FACILITY to prevent access to nearby structures to simplify climbing over it, such as light poles, site furnishings, overhanging tree limbs or other obvious footholds or handholds.

4.8.6.2.1.1 Horizontal Mid-Rails Horizontal mid-rails shall not be permitted.

4.8.6.2.1.2 Mesh Fencing Chain-link fencing constructed of a maximum opening of 1¾ inches (44.4 mm) mesh shall be permitted.

4.8.6.2.2^A Emergency Exit Paths ENCLOSURES for AQUATIC VENUES shall not block or encumber a required emergency egress path from other structures.

4.8.6.2.2.1 Pathways Where a required emergency egress path enters an area occupied by an outdoor AQUATIC VENUE, emergency exit pathways from the building(s) shall continue on DECK of least equally unencumbered width and continue to the ENCLOSURE and through gates.

4.8.6.2.2.2 Exit Pathways Exit pathways shall be separated with a BARRIER from AQUATIC VENUES not in operation.

4.8.6.2.2.3 Seasonal Separation Seasonal separation may be employed at seasonally operated AQUATIC VENUES, but shall be subject to the same physical requirements of permanent ENCLOSURES for AQUATIC VENUES in MAHC 4.8.6.

4.8.6.2.3 Windows Windows on a building that forms part of an ENCLOSURE around an AQUATIC VENUE shall have a maximum opening width not to exceed 4 inches (10.2 cm).

4.8.6.2.3.1 Opened If designed to be opened, windows shall also be provided with a non-removable screen.

4.8.6.2.4^A Height AQUATIC FACILITY ENCLOSURES shall be no less than 6 feet (1.83 m) in height..

4.8.6.2.4.1 Change in Grade Where a change in grade occurs at an ENCLOSURE, height shall be measured from the uppermost grade to the top of the ENCLOSURE.

4.8.6.2.4.2 Fencing Requirements Height shall be measured from the finished grade to the top of the ENCLOSURE on the side outside of the ENCLOSURE surrounding an AQUATIC VENUE.

4.8.6.2.4.3^A Other Barriers Not Serving as Part of an Enclosure Except where otherwise noted, all other BARRIERS not serving as part of an AQUATIC FACILITY ENCLOSURE shall not be less than 42 inches (1.1 m) in height.

4.8.6.2.5 Clearance Above Grade The maximum vertical clearance at the bottom of the AQUATIC VENUE OR AQUATIC FACILITY ENCLOSURE when measured on the side of the ENCLOSURE facing away from the enclosed space, shall not exceed:

- 1) 2 inches (5.1 cm) above grade when the ENCLOSURE rests on a non-solid surface, including grass or gravel or
- 2) 4 inches (10.2 cm) above grade when the ENCLOSURE rests on a solid surface.

4.8.6.3^A Gates and Doors

4.8.6.3.1 Self-Closing and Latching All primary public access gates or doors serving as part of an AQUATIC FACILITY ENCLOSURE or required AQUATIC VENUE ENCLOSURE shall be self-closing and self-latching from any open position.

4.8.6.3.1.1^A Self-latching Device Height Operable parts of the release latch on self-latching devices shall be located 4.5 feet (1.4 m) above finished grade.

4.8.6.3.1.2 Operable by Children Self-latching devices shall not be operable by small children on the outside of the ENCLOSURE around the AQUATIC VENUE.

4.8.6.3.1.3 Locked All gates or doors shall be capable of being locked from the exterior.

4.8.6.3.1.4 Emergency Egress Gates or doors shall be designed in such a way that they do not prevent egress in the event of an emergency.

4.8.6.3.1.5 Unauthorized Entry EXIT GATES or doors shall be constructed so as to prevent unauthorized entry from outside of the ENCLOSURE around the AQUATIC VENUE.

4.8.6.3.1.6^A Exceptions

4.8.6.3.1.6.1 Exception 1: Staffed Entry When the gate or door of an AQUATIC FACILITY or AQUATIC VENUE ENCLOSURE is part of a staffed entrance and is locked at all times the AQUATIC FACILITY or AQUATIC VENUE is not open to the public.

4.8.6.3.1.6.2 Exception 2: Lifeguard(s) Provided When the gate or door serves as part of an AQUATIC FACILITY or AQUATIC VENUE ENCLOSURE and the AQUATIC VENUE(S) therein has a QUALIFIED LIFEGUARD(S) conducting PATRON surveillance at all times the AQUATIC VENUE(S) is open and the gate or door is locked at all times the AQUATIC FACILITY or AQUATIC VENUE is not open to the public.

4.8.6.3.2 Gates Gates shall be at least equal in height at top and bottom to the ENCLOSURE of which they are a component.

4.8.6.3.3 Turnstiles Turnstiles shall not form a part of an AQUATIC FACILITY ENCLOSURE.

4.8.6.3.4 Exit Gates EXIT GATES shall be conspicuously marked on the inside of the AQUATIC VENUE or AQUATIC FACILITY.

4.8.6.3.4.1 Quantity, Location, and Width Quantity, location, and width(s) for EXIT GATES shall be provided consistent with all applicable local, state, territorial, federal, and tribal building and fire CODES and applicable accessibility guidelines.

4.8.6.3.5 Swing Outward EXIT GATES shall swing away from the AQUATIC VENUE ENCLOSURE except where emergency egress CODES require them to swing into the AQUATIC VENUE ENCLOSURE.

4.8.6.3.6 Absence of Building Codes Where local, state, territorial, federal, and tribal building CODES do not otherwise govern, at least one 36-inch (91.4 cm) wide EXIT GATE shall be required for emergency access to each logical AQUATIC VENUE area including individual POOLS or grade levels or both.

4.8.6.4 Indoor Aquatic Venues

4.8.6.4.1 Enclosure Building walls enclosing an INDOOR AQUATIC FACILITY may be designated as the AQUATIC FACILITY ENCLOSURE.

4.8.6.4.2 Securable Indoor AQUATIC VENUES shall be securable from unauthorized entry from other building areas or the exterior.

4.8.6.4.3^A Indoor and Outdoor Aquatic Venues Where separate indoor and outdoor AQUATIC VENUES are located on the same site, an AQUATIC VENUE ENCLOSURE shall be provided between them.

4.8.6.4.3.1 Year-Round Operation Exception: Where all AQUATIC VENUES are operated continuously 12 months a year on the same schedule.

4.8.6.4.4^A Wall Separating For a passage through a wall separating the indoor portion of an AQUATIC VENUE from an outdoor portion of the same AQUATIC VENUE, the overhead clearance of the passage to the AQUATIC VENUE floor shall be at least 6 feet 8 inches (2.0 m) to any solid structure overhead.

4.8.6.5^A Multiple Aquatic Venues

4.8.6.5.1 One Enclosure Except as otherwise required in this CODE, one ENCLOSURE may surround multiple AQUATIC VENUES at one facility.

4.8.6.5.2 Wading Pools WADING POOLS shall not require separation from other WADING POOLS

by a BARRIER. Refer to MAHC 4.12.9 for additional guidance about WADING POOLS.

4.8.7^A Aquatic Venue Cleaning Systems

4.8.7.1^A No Hazard The cleaning system provided shall not create an entanglement or suction entrapment hazard or interfere with the operation or use of the AQUATIC VENUE.

4.8.7.2 Common Cleaning Equipment If there are multiple AQUATIC VENUES at one AQUATIC FACILITY, the AQUATIC FACILITY may use common cleaning equipment.

4.8.7.3 Integral Vacuum Systems Use of integral vacuum systems, meaning a vacuum system that uses the main circulating pump or a dedicated vacuum pump connect to the POOL with PVC piping and terminating at the POOL with a flush-mounted vacuum port fitting, shall be prohibited.

4.8.7.4 GFCI Power Where used, PORTABLE VACUUM cleaning equipment shall be powered by circuits having GROUND-FAULT CIRCUIT INTERRUPTERS.

4.8.7.5 Low Voltage Any ROBOTIC CLEANERS shall utilize low voltage for all components that are immersed in the POOL water.

4.8.7.6^A GFCI Connection Any ROBOTIC CLEANER power supply shall be connected to a circuit equipped with a ground fault interrupter, and shall not be operated using an extension cord.

4.9 Filter/Equipment Room

4.9.1 Equipment Room

4.9.1.1^A General Requirements

4.9.1.1.1 Nonabsorbent Material The EQUIPMENT ROOM OR AREA floor shall be of concrete or other suitable material having a smooth SLIP-RESISTANT finish.

4.9.1.1.1.1 Positive Drainage The EQUIPMENT ROOM OR AREA floor shall have positive drainage, including a sump drain pump if necessary.

4.9.1.1.2 Floor Slope Floors shall have a slope toward the floor drain and/or sump drain pump adequate to prevent standing water at all times.

4.9.1.1.3 Opening The opening to the EQUIPMENT ROOM OR AREA shall be designed to provide access for all anticipated equipment.

4.9.1.1.4 Hose Bibb At least one hose bibb with BACKFLOW preventer shall be located in the EQUIPMENT ROOM or be accessible within an adequate distance of the EQUIPMENT ROOM so that a hose can service the entire EQUIPMENT ROOM.

4.9.1.2^A Construction

4.9.1.2.1 Size The size of the EQUIPMENT ROOM OR AREA shall provide working space to perform routine operations and equipment service.

4.9.1.2.1.1 Adequate Storage Space EQUIPMENT ROOMS also intended for STORAGE shall have adequate space provided for such STORAGE, without reducing the working spaces.

4.9.1.2.2 Lighting EQUIPMENT ROOMS or areas shall be lighted to provide 30 foot candles (323 lux) of illumination at floor level in accordance with IESNA guidelines.

4.9.1.3 Electrical

4.9.1.3.1 Conform to NEC All electrical wiring shall conform to the edition of NEC adopted by the AHJ.

4.9.1.3.2 Conform to NRTL Equipment, components, and their application and installation shall

conform to the NRTL listing.

4.9.1.4^A Ventilation

4.9.1.4.1 Code Conformance EQUIPMENT ROOM ventilation shall address:

- 1) COMBUSTION requirements,
- 2) Heat dissipation from equipment,
- 3) Humidity from surge or balance tanks,
- 4) Ventilation to the outside, and
- 5) Air quality.

4.9.1.5^A Markings

4.9.1.5.1 Piping Identified All piping in the EQUIPMENT ROOM shall be permanently identified by its use and the AQUATIC VENUE and AQUATIC FEATURE it serves.

4.9.1.5.1.1 Components to Identify Identification shall be provided for:

- 1) Main drains and SKIMMERS,
- 2) Filtered water,
- 3) Make-up water,
- 4) Backwash water,
- 5) Chlorine (*or DISINFECTION*) feeds,
- 6) Acid (*or pH*) feeds,
- 7) Compressed air lines,
- 8) Gutters,
- 9) Chemical sample piping, and
- 10) POOL heating lines.

4.9.1.5.2 Piping Marked All piping shall be marked with directional arrows as necessary to determine flow direction.

4.9.1.5.3 Valves Identified All valves shall be clearly identified by number with a brass tag, plastic laminate tags, or permanently affixed alternate.

4.9.1.5.3.1 Valves Described Valves shall be described as to their function and referenced in the operating instruction manual.

4.9.1.5.3.2 Piping Diagram A water-resistant, easily read, wall-mounted piping diagram shall be furnished and installed inside the EQUIPMENT ROOM.

4.9.1.6^A Equipment Rooms Containing Combustion Equipment [N/A]

4.9.1.7^A Separation from Chemical Storage Spaces

4.9.1.7.1 Equipment

4.9.1.7.1.1^A Contaminated Air Combustion equipment, air-handling equipment, and electrical equipment shall not be exposed to air contaminated with corrosive chemical fumes or vapors.

4.9.1.7.1.2^A Equipment Restrictions Spaces containing combustion equipment, air handling equipment, and/or electrical equipment and spaces sharing air distribution with spaces containing such equipment shall not be used as CHEMICAL STORAGE SPACES at the same time.

4.9.1.7.1.2.1 **Certified, Listed, and Labeled Exception:** Equipment CERTIFIED, LISTED, AND LABELED for use in that atmosphere shall be acceptable.

4.9.1.7.1.3^A **Isolated** Spaces containing combustion equipment, air-handling equipment, and/or electrical equipment and spaces sharing air distribution with spaces containing such equipment shall be isolated from CHEMICAL STORAGE SPACE air.

4.9.1.7.2 **Doors and Openings**

4.9.1.7.2.1^A **Between Equipment and Chemical Storage** A door or doors shall not be installed in a wall between such EQUIPMENT ROOMS and an interior CHEMICAL STORAGE SPACE.

4.9.1.7.2.2^A **No Openings** There shall be no ducts, grilles, pass-throughs, or other openings connecting such EQUIPMENT ROOMS to CHEMICAL STORAGE SPACES, except as permitted by the fire CODE.

4.9.1.7.2.3^A **Indoor Aquatic Facility Air** Spaces containing combustion equipment, air-handling equipment, and/or electrical equipment and spaces sharing air distribution with spaces containing such equipment shall be isolated from INDOOR AQUATIC FACILITY air.

4.9.1.7.2.3.1 **Certified, Listed, and Labeled Equipment Exception:** Equipment CERTIFIED, LISTED, AND LABELED for the atmosphere shall be acceptable.

4.9.1.7.2.4^A **No Openings** There shall be no ducts, grilles, pass-throughs, or other openings connecting such spaces to an INDOOR AQUATIC FACILITY.

4.9.1.7.2.4.1 **Air Handlers** Ducts which connect the INDOOR AQUATIC FACILITY to the duct connections of air handlers shall not be construed as connecting the air-handler space to the INDOOR AQUATIC FACILITY.

4.9.1.7.2.4.2 **HVAC Equipment Exception:** HVAC equipment which is rated for INDOOR AQUATIC FACILITY atmosphere and which serves only that INDOOR AQUATIC FACILITY shall be acceptable.

4.9.1.7.2.5^A **Openings / Gaps** Where building construction leaves any openings or gaps between floors and walls, or between walls and other walls, or between walls and ceilings, such gaps shall be permanently sealed against air leakage.

4.9.1.7.3 **Indoor Aquatic Facility Access**

4.9.1.7.3.1^A **Floor Slope** Where a door or doors must be installed in a wall between an EQUIPMENT ROOM and an INDOOR AQUATIC FACILITY, the floor of the EQUIPMENT ROOM shall slope per all applicable local, state, territorial, federal, and tribal building requirements back into the EQUIPMENT ROOM in such a way as to prevent any EQUIPMENT ROOM spills from running under the door into the INDOOR AQUATIC FACILITY.

4.9.1.7.3.1.1 **Four Inches Exception:** This requirement may be met by a floor all of which is at least 4 inches (10.2 cm) below the level of the nearest part of the INDOOR AQUATIC FACILITY floor.

4.9.1.7.3.1.2 **Dike Exception:** This requirement may be met by a continuous dike not less than 4 inches (10.2 cm) high located entirely within the EQUIPMENT ROOM, which will prevent spills from reaching the INDOOR AQUATIC FACILITY floor.

4.9.1.7.3.1.3 **Floor Drains** EQUIPMENT ROOM floor drains may be required by the AHJ.

4.9.1.7.3.2^A **Automatic Closer** Such door or doors between an EQUIPMENT ROOM and an INDOOR AQUATIC FACILITY shall be equipped with an automatic closer.

4.9.1.7.3.2.1 **Maintained to Close Reliably** The door, frame, and automatic closer shall be installed and maintained so as to ensure that the door closes completely and latches without human assistance.

4.9.1.7.3.3^A **Automatic Lock** Such door or doors between an EQUIPMENT ROOM and an INDOOR AQUATIC FACILITY shall be equipped with an automatic lock.

4.9.1.7.3.3.1^A **Restrict Access** Such lock shall require a key or combination to open from the INDOOR AQUATIC FACILITY side.

4.9.1.7.3.3.2 **One Hand** Such lock shall be so designed and installed as to be opened by one hand from the inside of the room under all circumstances, without the use of a key or tool.

4.9.1.7.3.4 **Warning Sign** Such doors shall be equipped with permanent signage warning against unauthorized entry.

4.9.1.7.3.5 **Gasket** All sides of such doors shall be equipped with a gasket.

4.9.1.7.3.5.1 **Prevent Air Passage** The gasket shall be so installed as to prevent the passage of air, fumes, or vapors when the door is closed.

4.9.1.7.3.6 **Not Relief** This section shall not be construed as granting relief from MAHC 4.9.1.7.2.1.

4.9.1.8 Other Equipment Room Guidance

4.9.1.8.1^A **Access Space** Where ventilation, air filtration, or space dehumidification, heating, or cooling for an INDOOR AQUATIC FACILITY is by mechanical equipment located in an EQUIPMENT ROOM, adequate access space shall be provided to allow for inspection and service.

4.9.1.8.1.1^A **Size Requirements** The access spaces shall be the greater of:

- 1) Those required by OSHA, NEC, National Fuel Gas Code, or other official requirements or
- 2) The equipment manufacturers' recommendations.

4.9.1.8.2^A **Adequate Space** Where ventilation, air filtration, or space heating or cooling for an INDOOR AQUATIC FACILITY is beside mechanical equipment located in an EQUIPMENT ROOM, adequate space for required straight lengths of duct shall be provided as the greater of those described in AMCA 201, SMACNA Duct Manual, ACCA Manual SPS Sec. 13, or the equipment manufacturer's recommendations.

4.9.1.8.3^A **Minimize Hazards** Where an EQUIPMENT ROOM contains equipment requiring regular service or maintenance, the room shall be so designed and constructed as to minimize the hazards of such maintenance and service.

4.9.1.8.3.1 **Ladder Installed** Where a ladder will be required for service or maintenance of equipment, other permanently installed equipment shall not be so located as to interfere with the use of the ladder.

4.9.1.8.3.2 **Alternative Access** Where a ladder cannot be safely or practically used to service equipment where any serviceable component is more than 6.5 feet (2.0 m) above the floor, a mezzanine floor, platform, or other arrangement for safe access shall be provided.

4.9.1.8.3.2.1 **Exception Exception:** Where otherwise specifically allowed by OSHA.

4.9.1.8.3.2.2 **Stricter Requirements Exception:** Where OSHA or other applicable CODES or STANDARDS have stricter requirements, those stricter requirements shall prevail.

4.9.1.8.4^A **Refrigeration Equipment** Where refrigeration equipment such as an air-conditioner or dehumidifier is located indoors in a building intended for occupation, arrangements for refrigerant relief (*if any*) shall be according to the applicable mechanical CODE or other applicable CODE.

4.9.2^A **Chemical Storage Spaces** Nothing in this section shall be construed as providing relief from applicable requirements of fire CODES, mechanical CODES, electrical CODES, etc.

4.9.2.1 Outdoor / Indoor Storage

4.9.2.1.1 **Stored Outdoors** If POOL chemicals, acids, salt, oxidizing cleaning materials, or other corrosive or oxidizing chemicals are STORED outdoors, they shall be stored in a well-ventilated protective area with an installed ENCLOSURE to prevent unauthorized access as per MAHC 4.9.2.3.

4.9.2.1.2 **Minimize Vapors** Where such materials must be stored in a building intended for occupancy, the transfer of chemical fumes and vapors from the CHEMICAL STORAGE SPACE to other parts of the building shall be minimized.

4.9.2.1.3^A **Dedicated Space** At least one space dedicated to CHEMICAL STORAGE SPACE shall be provided to allow safe STORAGE of the chemicals present.

4.9.2.1.4^A **Eyewash** In all CHEMICAL STORAGE SPACES in which POOL chemicals will be STORED, an emergency eyewash station shall be provided.

4.9.2.2^A **Construction**

4.9.2.2.1 **Foreseeable Hazards** The construction of the CHEMICAL STORAGE SPACE shall take into account the foreseeable hazards.

4.9.2.2.2 **Protected** The construction of the CHEMICAL STORAGE SPACE shall, to the extent practical, protect the STORED materials against tampering, incompatible chemicals and materials, high humidity, unintended exposure to water, direct sunlight, sources of ignition, and temperature extremes (*i.e.* 32°F [0°C] and below and/or over 95°F [35°C]).

4.9.2.2.3^A **Floor** The floor or DECK of the CHEMICAL STORAGE SPACE shall be protected against substantial chemical damage.

4.9.2.2.4 **Minimize Fumes** The construction and operation of a CHEMICAL STORAGE SPACE shall minimize the transfer of chemical fumes into any INTERIOR SPACE of a building intended for occupation.

4.9.2.2.5 **Surfaces** Any walls, floors, doors, ceilings, and other building surfaces of an interior CHEMICAL STORAGE SPACE shall join each other tightly.

4.9.2.2.6^A **No Openings** There shall be no permanent or semi-permanent opening between a CHEMICAL STORAGE SPACE and any other INTERIOR SPACE of a building intended for occupation unless compliant with MAHC 4.9.2.4.3, 4.9.2.4.4, and 4.9.2.4.5.

4.9.2.3^A **Exterior Chemical Storage Spaces**

4.9.2.3.1 **Outdoor Equipment** Equipment listed for outdoor use may be located in an exterior CHEMICAL STORAGE SPACES as permitted.

4.9.2.3.2^A **Enclosure** Exterior CHEMICAL STORAGE SPACES not joined to a wall of a building shall have a complete ENCLOSURE consisting of fencing or other similar constructed feature that is at least 6 feet (1.8 m) high and meets the non-climbability requirements of MAHC 4.8.6.2.1.

4.9.2.3.3 **Gate** Fencing shall be equipped with a self-closing and self-latching gate having a permanent locking device.

4.9.2.4^A **Chemical Storage Space Doors**

4.9.2.4.1^A **Signage** All doors opening into CHEMICAL STORAGE SPACES shall be equipped with permanent signage:

- 1) Warning against unauthorized entry,
- 2) Specifying the expected hazards,
- 3) Specifying the location of the associated SDS forms, and
- 4) Product chemical hazard NFPA chart.

4.9.2.4.2^A **Emergency Egress** Where a single door is the only means of egress from a CHEMICAL STORAGE SPACE, the door shall be equipped with an emergency-egress device.

4.9.2.4.3^A **Interior Door** Where a CHEMICAL STORAGE SPACE door must open to an INTERIOR SPACE, spill containment shall be provided to prevent spilled chemicals from leaving the CHEMICAL STORAGE

SPACE.

4.9.2.4.4^A **Equipment Space** Where a CHEMICAL STORAGE SPACE door must open to an INTERIOR SPACE, the door shall not open to a space containing combustion equipment, air-handling equipment, or electrical equipment.

4.9.2.4.4.1^A **Corrosive** Such door shall be acceptable where all equipment thus exposed is listed for the corrosive atmosphere.

4.9.2.4.5 **Interior Opening** Where a CHEMICAL STORAGE SPACE door must open to an INTERIOR SPACE, such door shall have all of the following requirements outlined from MAHC 4.9.2.4.5.1 to 4.9.2.4.5.7.2.

4.9.2.4.5.1 **Corrosion Resistant** Such doors shall be constructed of corrosion-resistant materials.

4.9.2.4.5.2^A **Automatic Lock** Such doors shall be equipped with a corrosion-resistant, automatic lock to prevent unauthorized entry.

4.9.2.4.5.2.1 **Key or Combination** Such lock shall require a key or combination to open from the outside into the CHEMICAL STORAGE SPACE.

4.9.2.4.5.2.2 **Opened** Such lock shall be so designed and installed as to be capable of being opened by one hand from the inside of the CHEMICAL STORAGE SPACE without the use of a key or tool.

4.9.2.4.5.3 **Supported** Such doors shall be supported on corrosion-resistant hinges, tracks, or other supports.

4.9.2.4.5.4 **Air Leakage** Such doors shall be equipped with suitable gaskets or seals on the top and all sides to minimize air leakage between the door and the door frame.

4.9.2.4.5.5 **Floor** Such doors shall be equipped with a floor or threshold seal to minimize air leakage between the door and the floor or threshold.

4.9.2.4.5.6 **Automatic Closer** Such doors shall be equipped with an automatic door closer that will completely close the door and latch without human assistance.

4.9.2.4.5.6.1 **Air Pressure** The door closer shall be able to close the door completely against the specified difference in air pressure.

4.9.2.4.5.7 **Limit Switch** Such doors shall be equipped with a limit switch and an alarm that will sound if the door remains open for more than 30 minutes.

4.9.2.4.5.7.1 **Alarm** This alarm shall have a minimum output level of 85 dbA at 10 feet (3.0 m).

4.9.2.4.5.7.2 **Loss of Air Pressure** Where an open door will result in loss of air-pressure difference, this requirement can be met by the audible alarm required under MAHC 4.9.2.5.2.4.

4.9.2.5^A **Interior Chemical Storage Spaces**

4.9.2.5.1^A **No Air Movement** There shall be no transfer grille, pass-through grille, louver, or other device or opening that will allow air movement from the CHEMICAL STORAGE SPACE into any other INTERIOR SPACE of a building intended for occupancy or into another CHEMICAL STORAGE SPACE.

4.9.2.5.2^A **Electrical Conduit System** Interior CHEMICAL STORAGE SPACES that share any building surface (*wall, floor, ceiling, door, etc.*) with any other INTERIOR SPACE shall be equipped with a ventilation system that operates continuously and ensures that all air movement is from all other INTERIOR SPACES and toward the CHEMICAL STORAGE SPACE.

4.9.2.5.2.1 **Additional Interior Space** Interior CHEMICAL STORAGE SPACES that share an electrical conduit system with any other INTERIOR SPACE shall be equipped with a ventilation system that operates continuously and ensures that all air movement is from all other INTERIOR SPACES and toward the

CHEMICAL STORAGE SPACE.

4.9.2.5.2.2^A **Pressure Difference** This pressure difference shall be maintained by a continuously operated exhaust system used for no other purpose than to remove air from that one CHEMICAL STORAGE SPACE.

4.9.2.5.2.3 **Separate Exhaust System** Where more than one CHEMICAL STORAGE SPACE is present, a separate exhaust system shall be provided for each CHEMICAL STORAGE SPACE.

4.9.2.5.2.3.1 **Airflow Rate** The exhaust airflow rate shall be the greater of the:

- 1) OSHA requirements for working in such enclosed spaces,
- 2) Amount needed to maintain the concentration of vapors or fumes below the PEL for the expected exposure time (defined by 29 CFR 1910.1000 [OSHA]) for each stored chemical,
- 3) Amount specified by International Mechanical Code,
- 4) Amount specified by the Uniform Mechanical Code, or
- 5) Amount needed to maintain the specified pressure difference.

4.9.2.5.2.4^A **Alarm** The function of this exhaust system shall be MONITORED continuously by an audible differential-pressure alarm system which shall sound if the specified differential air pressure is not maintained for a period of 30 minutes.

4.9.2.5.2.4.1 **Minimum Output** This alarm shall have a minimum output level of 85 dbA at 10 feet (3.0 m).

4.9.2.5.2.4.2 **Manual Reset** The specified alarm shall require manual reset to silence it.

4.9.2.6 Air Ducts in Interior Chemical Storage Spaces

4.9.2.6.1^A **No Air Movement** No duct shall allow air movement from the CHEMICAL STORAGE SPACE into any other INTERIOR SPACE of a building intended for occupation or into any other CHEMICAL STORAGE SPACE.

4.9.2.6.2 **Chemical Storage** Air ducts shall not enter or pass through an interior CHEMICAL STORAGE SPACE.

4.9.2.6.2.1 **Corrosion Resistant Exception:** A corrosion-resistant duct used for no other purpose than to exhaust air from the CHEMICAL STORAGE SPACE shall be acceptable.

4.9.2.6.2.1.1 **Building Exterior** This corrosion-resistant duct shall exhaust to the exterior and must end at a point on the exterior of the building, at least 20 feet (6.1 m) from any air intake for breathing air, cooling air, or combustion air.

4.9.2.6.2.2 **Makeup Air Exception:** A duct used for no other purpose than to supply makeup air to the CHEMICAL STORAGE SPACE shall be acceptable.

4.9.2.6.2.2.1 **Building Exterior** This makeup air supply duct shall end at a point on the exterior of the building, at least 20 feet (6.1 m) from any air intake for breathing air, cooling air, or combustion air.

4.9.2.6.2.3 **Other Ducts Exception:** Any other ducts specifically allowable by applicable building and mechanical CODES where such ducts are corrosion resistant and joint free to the extent feasible shall be acceptable.

4.9.2.7 Pipes and Tubes in Interior Chemical Storage Spaces

4.9.2.7.1 **Not Enter** Pipes and tubes shall not enter or pass through an interior CHEMICAL STORAGE SPACE.

4.9.2.7.1.1 **Service Exception:** As required to service devices integral to the function of the

CHEMICAL STORAGE SPACE, such as pumps, vessels, controls, freeze protection, and safety devices.

4.9.2.7.1.2 Automatic Fire Suppression Exception: As required to allow for automatic fire suppression where required.

4.9.2.7.1.3 Drainage Exception: As required for drainage.

4.9.2.7.2 Devices Piping, tubes, drain bodies, grates, and attachment and restraint devices shall be corrosion resistant and rated for the chemical environment(s) present including floor drain bodies and grates.

4.9.2.7.3 Wall Penetrations All wall penetrations shall be sealed air-tight.

4.9.2.7.3.1 Rating All wall penetrations shall be commensurate with the rating of the wall assembly.

4.9.2.7.3.2 Sealing Materials Sealing material(s) shall be compatible with the wall assembly and the chemical environment(s) present.

4.9.2.8^A Combustion Equipment in Interior Chemical Storage Spaces

4.9.2.8.1 Installed No COMBUSTION DEVICE or appliance shall be installed in a CHEMICAL STORAGE SPACE, or in any other place where it will be exposed to the air from a CHEMICAL STORAGE SPACE.

4.9.2.8.1.1 Exception Exception: A COMBUSTION DEVICE or appliance which meets all of the following requirements shall be acceptable:

- 1) The device or appliance is required for one or more processes integral to the function of the room, such as space heat;
- 2) The device is listed for such use; and
- 3) The device as installed is acceptable to the AHJ.

4.9.2.9 Electrical Equipment in Chemical Storage Spaces Electrical equipment and wiring methods used for or in CHEMICAL STORAGE SPACES shall comply with MAHC 4.9.2.

4.9.2.10 Ozone Rooms

4.9.2.10.1 Only Ozone Equipment An ozone EQUIPMENT ROOM shall not be used for STORAGE of chemicals, solvents, or any combustible materials, other than those required for the operation of the recirculation and ozone generating equipment.

4.9.2.10.2 Emergency Ventilation Rooms which are designed to include ozone equipment shall be equipped with an emergency ventilation system capable of six air changes per hour.

4.9.2.10.2.1 Exhaust Intake The exhaust intake shall be located approximately 6 inches (15.2 cm) from the floor, on the opposite side of the room from the make-up air intake.

4.9.2.10.2.2 On Command The emergency ventilation system shall be so arranged as to run on command of an ozone-leak alarm or on command of a manual switch.

4.9.2.10.2.3 Manual Switch The manual emergency ventilation switch shall be located outside the room and near the door to the ozone room.

4.9.2.10.3 Below Grade Ozone rooms which are below grade shall be equipped with forced-draft ventilation capable of six air changes per hour.

4.9.2.10.3.1 Exhaust Intake The exhaust intake shall be located approximately 6 inches (15.2 cm) from the floor, on the opposite side of the room from the make-up air intake.

4.9.2.10.3.2 Arranged Such ventilation system shall be so arranged as to:

- 1) Run automatically concurrent with the ozone equipment and for at least a time allowing for 15 air changes after the ozone equipment is stopped,

- 2) Run upon activation of the ozone detection and alarm system, and
- 3) Run on command of a manual switch.

4.9.2.10.3.3 Manual Ventilation Switch The manual ventilation switch shall be located outside the room and near the door to the ozone room.

4.9.2.10.4 Signage In addition to the signs required on all CHEMICAL STORAGE SPACES, a sign shall be posted on the exterior of the entry door, stating “DANGER - GASEOUS OXIDIZER – OZONE” in lettering not less than 4 inches (10.2 cm) high.

4.9.2.10.5 Alarm System Rooms containing ozone generation equipment shall be equipped with an audible and visible ozone detection and alarm system.

4.9.2.10.5.1 Requirements The alarm system shall consist of both an audible alarm capable of producing at least 85 decibels at 10 feet distance (3.0 m), and a visible alarm consisting of a flashing light mounted in plain view of the entrance to the ozone-EQUIPMENT ROOM.

4.9.2.10.5.2 Sensor The ozone sensor shall be located at a height of 18–24 inches (45.7–61.0 cm) above floor level.

4.9.2.10.5.2.1 Measuring The ozone sensor shall be capable of measuring ozone in the range of 0–2 ppm (mg/L).

4.9.2.10.5.3 Ozone Concentration The alarm system shall alarm when the ozone concentration equals or exceeds 0.1 ppm (mg/L) in the room.

4.9.2.10.5.4 Activation Activation of the alarm system shall shut off the ozone generating equipment and turn on the emergency ventilation system.

4.9.2.11^A Gaseous Chlorination Space As per MAHC 4.7.3.2.4.1, use of compressed CHLORINE gas shall be prohibited for new construction and after SUBSTANTIAL ALTERATION to existing AQUATIC FACILITIES.

4.9.2.11.1 Existing Facilities MAHC 4.9.2.11 shall apply to existing facilities using compressed CHLORINE gas.

4.9.2.11.2 Adequate Size A gaseous-chlorination space shall be large enough to house the chlorinator, CHLORINE STORAGE tanks, and associated equipment as required.

4.9.2.11.3 Secure Tanks A gaseous-chlorination space shall be equipped with facilities for securing tanks.

4.9.2.11.4 Not Below Grade A gaseous-chlorination space shall not be located in a basement or otherwise be below grade.

4.9.2.11.5 Compressed-Chlorine Gas Where installed indoors, compressed-CHLORINE gas STORAGE containers and associated chlorinating equipment shall be in a separate room constructed to have a fire rating of not less than 1-hour.

4.9.2.11.6 Entry Door The entry door to an indoor gaseous-CHLORINE space shall open to the exterior of the building or structure.

4.9.2.11.6.1 Pool or Deck The entry door to an indoor gaseous-CHLORINE space shall not open directly towards a POOL or DECK.

4.9.2.11.7 Inspection Window An indoor gaseous-CHLORINE space shall be provided with a shatterproof gas-tight inspection window.

4.9.2.11.8 Ventilation Indoor gaseous-chlorination spaces shall be provided with a spark-proof ventilation system capable of 60 air changes per hour.

4.9.2.11.8.1 Exhaust-Air Intake The exhaust-air intake of the ventilation system shall be taken at

a point within 6 inches (*15.2 cm*) of the floor, and on the opposite side of the room from the makeup-air intake.

4.9.2.11.8.2 Discharge Point The exhaust-air discharge point shall be:

- 1) Outdoors,
- 2) Above adjoining grade level,
- 3) At least 20 feet (*6.1 m*) from any operable window, and
- 4) At least 20 feet (*6.1 m*) from any adjacent building.

4.9.2.11.8.3 Make-Up Intake The make-up air intake shall be within 6 inches (*15.2 cm*) of the ceiling of the space.

4.9.2.11.8.3.1 Open Outdoors The make-up air intake shall open directly to the outdoors.

4.9.2.11.8.4 Personal Protective Equipment Available PPE, consisting of at least a gas mask approved by NIOSH for use with CHLORINE atmospheres, shall be stored directly outside one entrance to an indoor gaseous-chlorination space.

4.9.2.11.8.5 SCBA Systems A minimum of two SCBA systems shall be on hand at all times and two QUALIFIED OPERATORS are to be involved in the changing of the tanks.

4.9.2.11.8.6 Stationed Outside One of the QUALIFIED OPERATORS should be stationed outside of the chemical room where the QUALIFIED OPERATOR inside can be seen at all times.

4.9.2.11.8.7 Emergency Telephone An emergency direct line telephone shall be located by the door.

4.9.2.12 Windows in Chemical Storage Spaces

4.9.2.12.1^A Not Required Windows in CHEMICAL STORAGE SPACES shall not be required by this CODE.

4.9.2.12.2^A Requirements Where a window is to be installed in an interior wall, ceiling, or door of a CHEMICAL STORAGE SPACE, such window shall have the following components:

- 1) Tempered or plasticized glass,
- 2) A corrosion-resistant frame, and
- 3) Incapable of being opened or operated.

4.9.2.12.3 Exterior Window Any CHEMICAL STORAGE SPACE window in an exterior wall or ceiling shall:

- 1) Be mounted in a corrosion-resistant frame and
- 2) Be so protected by a roof, eave or permanent awning as to minimize the entry of rain or snow in the event of window breakage.

4.9.2.13 Sealing and Blocking Materials

4.9.2.13.1 Minimize Leakage Materials used for sealing and blocking openings in an interior CHEMICAL STORAGE SPACE shall minimize the leakage of air, vapors, or fumes from the CHEMICAL STORAGE SPACE.

4.9.2.13.2 Compatible Materials used for sealing and blocking openings in an interior CHEMICAL STORAGE SPACE shall be compatible for use in the environment.

4.9.2.13.3 Fire Rating Materials used for sealing and blocking openings in an interior CHEMICAL STORAGE SPACE shall be commensurate with the fire rating of the assembly in which they are installed.

4.10 Hygiene Facilities

4.10.1^A General

4.10.1.1 New Construction or Substantial Alteration All design provisions shall be required for new construction or SUBSTANTIAL ALTERATION to an existing AQUATIC FACILITY.

4.10.1.1.1 At Time of Adoption Exception: the following MAHC sections shall be required for all AQUATIC FACILITIES at time of adoption or within 1 year of adoption as stated:

- 1) MAHC 4.10.4.5: Diaper-changing stations,
- 2) MAHC 4.10.4.6.5: Soap Dispensers, and
- 3) MAHC 4.10.4.6.9: Trash Can

4.10.1.2^A Minimum to Provide AQUATIC FACILITIES shall provide HYGIENE FACILITIES that include, at a minimum, toilets, urinals, SHOWERS, DIAPER-CHANGING STATIONS, and other HYGIENE FIXTURES, as specified herein.

4.10.1.3 Construction HYGIENE facilities shall be constructed in accordance with all applicable local, state, territorial, federal, and tribal laws or as modified herein.

4.10.1.4 Minimum Toilets, Urinals, and Other Fixtures The minimum number of toilets, urinals, and other HYGIENE FIXTURES provided, excluding SHOWERS, shall be the greater of the following two options:

- 1) In accordance with all applicable local, state, territorial, federal, and tribal laws or
- 2) Based upon maximum theoretical peak occupancy of each aquatic venue.

4.10.1.5^A Theoretical Peak Occupancy THEORETICAL PEAK OCCUPANCY for all AQUATIC VENUES shall be calculated as defined in MAHC 4.1.2.3.5.3.

4.10.2 Location

4.10.2.1^A Distance Except as required in MAHC 4.10.2.2, a drinking fountain, toilet, HANDWASHING STATION, and DIAPER-CHANGING STATION shall be located no greater than 300 feet (91 m) walking distance from each AQUATIC VENUE.

4.10.2.2^A Children Less than Five Years of Age An AQUATIC VENUE designed primarily for use by children less than 5 years of age shall have a drinking fountain, toilet, HANDWASHING STATION, and DIAPER-CHANGING STATION located no greater than 200 feet (61 m) walking distance and in clear view from the nearest entry/exit of the AQUATIC VENUE.

4.10.3^A Design and Construction

4.10.3.1 Floors The floors of HYGIENE FACILITIES and dressing areas serving AQUATIC FACILITIES shall have a smooth, easily cleaned, impervious-to-water, SLIP-RESISTANT surface.

4.10.3.2^A Floor Base A hard, smooth, impervious-to-water, easily cleaned base shall provide a sealed, coved juncture between the wall and floor and extend upward on the wall at least 6 inches (15.2 cm).

4.10.3.3 Floor Drains Floor drains shall be installed in HYGIENE FACILITIES and dressing areas where PLUMBING FIXTURES are located.

4.10.3.3.1^A Opening Grill Covers Floor drain opening grill covers shall be ½-inch (1.3 cm) or less in width or diameter.

4.10.3.3.2^A Sloped to Drain Floors shall be sloped to drain water or other liquids.

4.10.3.3.2.1 Accessible Routes Where DECK areas serve as ACCESSIBLE ROUTES or portions thereof, slopes in any direction shall not exceed ADA STANDARDS and MAHC 4.8.1.3.1.

4.10.3.4 Partitions and Enclosures Partitions and ENCLOSURES adjacent to HYGIENE FACILITIES shall have a smooth, easy-to-clean, impervious surface.

4.10.3.5^A Hose Bibb At least one hose bibb or other potable water source capable of connecting a hose shall be located in each HYGIENE FACILITY to facilitate cleaning.

4.10.4^A Plumbing Fixture Requirements

4.10.4.1 General

4.10.4.1.1^A Protected PLUMBING FIXTURES shall be installed and operated in a manner to adequately protect the potable water supply from back siphonage or BACKFLOW in accordance with all applicable local, state, territorial, federal, and tribal laws.

4.10.4.1.2 Easily Cleaned PLUMBING FIXTURES shall be designed so that they may be readily and frequently cleaned, SANITIZED, and disinfected.

4.10.4.1.3^A Toilet Counts Total toilet or urinal counts shall be in accordance with all applicable local, state, territorial, federal, and tribal laws or as modified herein.

4.10.4.1.4 Hand Wash Sink Handwashing sink counts shall be in accordance with all applicable local, state, territorial, federal, and tribal laws or as modified herein.

4.10.4.2^A Cleansing Showers

4.10.4.2.1^A Count The minimum number of CLEANSING SHOWERS shall be one per sex for AQUATIC FACILITIES less than 4000 square feet (372 m^2) in collective AQUATIC VENUE surface area.

4.10.4.2.1.1 Additional Cleansing Showers An additional CLEANSING SHOWER per sex shall be added for each additional 4000 square feet (372 m^2) of AQUATIC VENUE space or portion thereof.

4.10.4.2.2 Distributed CLEANSING SHOWERS shall be evenly distributed between sexes, as applicable.

4.10.4.2.3^A Location CLEANSING SHOWERS shall be located in a HYGIENE FACILITY that is near the entrance and within clear view of the AQUATIC VENUE.

4.10.4.2.4^A Enclosed Entryways to private or group CLEANSING SHOWER areas shall be enclosed by a door or curtain.

4.10.4.2.4.1 Doors SHOWER doors shall be of a smooth, hard, easy-to-clean material.

4.10.4.2.4.2 Curtains SHOWER curtains shall be of a smooth, easy-to-clean material.

4.10.4.2.5 Soap Dispenser CLEANSING SHOWERS shall be supplied with soap and a soap dispenser adjacent to the SHOWER.

4.10.4.2.6^A Exemption AQUATIC VENUES located in lodging and residential settings shall be exempt from MAHC 4.10.4.2.

4.10.4.3^A Rinse Showers

4.10.4.3.1 Minimum and Location A minimum of one RINSE SHOWER shall be provided on the DECK near an entry point to the AQUATIC VENUE.

4.10.4.3.2 Temperature Water used for RINSE SHOWERS may be at ambient temperature.

4.10.4.3.3^A Floor Sloped Floors of RINSE SHOWERS shall be sloped to drain wastewater away from the AQUATIC VENUE and meet applicable local, state, territorial, federal, and tribal laws.

4.10.4.3.4^A Large Aquatic Facilities RINSE SHOWERS in AQUATIC FACILITIES greater than 7500 square feet (697 m^2) of water surface area shall be situated adjacent to each AQUATIC VENUE entry point or arranged to encourage BATHERS to use the RINSE SHOWER prior to entering the AQUATIC VENUE.

4.10.4.3.5^A Beach Entry A minimum of four showerheads per 50 feet (15.2 m) of beach entry AQUATIC VENUES shall be provided as a RINSE SHOWER.

4.10.4.3.6^A Lazy River A minimum of one RINSE SHOWER shall be provided at each entrance to a LAZY RIVER AQUATIC VENUE.

4.10.4.3.7^A Waterslide A minimum of one RINSE SHOWER shall be provided at each entrance to a WATERSLIDE queue line.

4.10.4.4^A All Showers AQUATIC FACILITIES with 7500 square feet (697 m²) of water area or more may be flexible in the number of CLEANSING SHOWERS they provide based on the THEORETICAL PEAK OCCUPANCY in MAHC 4.1.2.3.5:

- 1) 25% of the required SHOWERS shall be CLEANSING SHOWERS,
- 2) 25% of the required SHOWERS shall be RINSE SHOWERS, and
- 3) the remaining 50% may be either cleansing or RINSE SHOWERS.

4.10.4.5^A Diaper-Changing Stations

4.10.4.5.1 Each Facility All AQUATIC FACILITIES allowing use by diaper-aged BATHERS shall, upon adoption of this CODE, have at least one DIAPER-CHANGING STATION in each male and female HYGIENE FACILITY or make available a unisex DIAPER-CHANGING STATION.

4.10.4.5.1.1^A Hand Wash Sink For existing AQUATIC FACILITIES, the adjacent plumbed handwashing sink shall be installed and operational within 1 year from the date of the AHJ's adoption of the MAHC.

4.10.4.5.1.2^A Portable For existing AQUATIC FACILITIES that do not yet have an adjacent plumbed handwashing sink as specified in MAHC 4.10.4.5.1.1, a portable HANDWASHING STATION shall be available adjacent to the station at all times.

4.10.4.5.2^A Conform DIAPER-CHANGING UNITS shall conform to either of the following STANDARDS:

- 1) ASTM Standard F2285-04: *Consumer Performance Standards for Commercial Diaper-Changing Stations* or
- 2) The STANDARDS for diaper-changing surfaces in the most current version of *Caring for Our Children: National Health and Safety Performance Standards: Guidelines for Out-of-Home Child Care Programs*.

4.10.4.5.3^A Unisex If only a unisex HYGIENE FACILITY is provided, it shall have a DIAPER-CHANGING STATION that conforms to MAHC 4.10.4.5.

4.10.4.5.4^A Trash Can A covered, hands-free, plastic-lined trash receptacle or diaper pail shall be located directly adjacent to the DIAPER-CHANGING UNIT.

4.10.4.5.5 Disinfecting Surface An EPA-REGISTERED disinfectant shall be provided for maintaining a clean and disinfected DIAPER-CHANGING UNIT surface before and after each use.

4.10.4.6 Non-Plumbing Fixture Requirements

4.10.4.6.1 Easy to Clean All HYGIENE FIXTURES and appurtenances in the dressing area shall have a smooth, hard, easy-to-clean, impervious-to-water surface and be installed to permit thorough cleaning.

4.10.4.6.2 Glass Glass, excluding mirrors, shall not be permitted in HYGIENE FACILITIES.

4.10.4.6.3 Mirrors Mirrors shall be shatter resistant.

4.10.4.6.4^A Lockers If lockers are provided, they shall be installed at least 3.5 inches (8.9 cm) above the finished floor or on legs or a base at least 3.5 inches (8.9 cm) high and far enough apart to allow for cleaning and drying underneath the locker.

4.10.4.6.5 Soap Dispensers Soap dispensers shall be securely attached adjacent to handwashing sinks and at each CLEANSING SHOWER.

4.10.4.6.5.1 Dispenser Materials The dispensers shall be of all metal, plastic, or other shatterproof materials that can be readily and frequently cleaned.

4.10.4.6.6^A Dryers / Paper Towels Hand dryers or paper towel dispensers shall be provided and securely attached adjacent to handwashing sinks.

4.10.4.6.6.1 Materials Hand dryers and paper towel dispensers shall be of all metal, plastic or other shatterproof materials that can be readily and frequently cleaned.

4.10.4.6.7 Toilet Paper Dispensers Toilet paper dispensers shall be securely attached to wall or partition adjacent to each toilet.

4.10.4.6.8 Female Facilities In female HYGIENE FACILITIES, covered receptacles adjacent to each toilet shall be provided for disposal of used feminine hygiene products.

4.10.4.6.9 Trash Can A minimum of one hands-free trash receptacle shall be provided in areas adjacent to handwashing sinks.

4.10.5^A Provision of Suits, Towels, and Shared Equipment

4.10.5.1 Adequate Space AQUATIC FACILITIES supplying reusable suits, towels, and/or shared equipment shall provide adequate equipment and space for cleaning, sanitizing, drying, and storing of these materials.

4.10.6^A Foot Baths

4.10.6.1 Prohibited FOOT BATHS shall be prohibited.

4.10.7^A Sharps

4.10.7.1 Container If razors or other sharps are supplied by the AQUATIC FACILITY, a sharps container that complies with all applicable local, state, territorial, federal, and tribal laws shall be provided within the HYGIENE FACILITY.

4.11 Water Supply/ Wastewater Disposal

4.11.1 Water Supply

4.11.1.1^A Public Water System Water serving an AQUATIC FACILITY shall be supplied from a potable water source.

4.11.1.1.1^A Other Sources Other water sources such as lakes or springs may be approved to serve an AQUATIC FACILITY by the AHJ.

4.11.1.1.2^A Condensate / Reclaimed Water Use of condensate water, collected rain water, or other reclaimed water for water serving an AQUATIC VENUE is prohibited.

4.11.1.1.2.1 Condensate Use Condensate water may be used for irrigation or other non-potable uses.

4.11.1.1.2.2 Exceptions Exceptions to MAHC 4.11.1.1.2 may be made by the AHJ with evidence that such water has met all EPA potable water quality STANDARDS.

4.11.1.2^A Sufficient Capacity The water supply shall have sufficient capacity to simultaneously serve all PLUMBING FIXTURES.

4.11.1.2.1 Refill Pool The water supply shall have sufficient capacity and pressure to refill the AQUATIC VENUE to the operating water level after backwashing filters and after any splashing or evaporative losses within 1 hour if the AQUATIC VENUE is operational at the time of the backwash.

4.11.2^A Fill Spout

4.11.2.1 Hazard If a fill spout is used at an AQUATIC VENUE, the fill spout shall be located so that it is not a SAFETY hazard to BATHERS.

4.11.2.2 Shielded A fill spout shall be located so the possibility of it becoming a trip hazard is minimized.

4.11.2.3 Open End The open end of fill spouts shall not have sharp edges or protrude more than 2 inches (50.8 mm) beyond the edge of the POOL.

4.11.2.4 Air Gap The discharge end shall be separated from the water by a vertical air gap of at least 2 pipe diameters measured from the pipe outlet to the edge of the POOL.

4.11.3^A Cross-Connection Control

4.11.3.1 Protected The potable water supply serving an AQUATIC VENUE shall be protected against BACKFLOW consisting of either of the following:

- 1) An acceptable air gap consisting of a vertical distance of not less than two pipe diameters of the water supply pipe or 6 inches (15.2 cm), whichever is greater, over the lowest free-flowing discharge point of the receiving pipe, tank, or vessel. Splash guards that are open to the atmosphere may be used around the air gap, or
- 2) Where permitted, an approved RPZ BACKFLOW preventer installed according to the plumbing CODE and the AHJ.

4.11.4 Deck Drains and Rinse Showers

4.11.4.1 Sloped Walkway The walkway or DECK around an AQUATIC VENUE shall be properly sloped to DECK drains or to the edge of the DECK to prevent the accumulation of standing water.

4.11.4.2 Discharge If DECK drains are provided, the drains shall discharge to the sanitary or storm sewer or as otherwise allowed by the AHJ and according to applicable plumbing CODES.

4.11.4.3 Area or Linear DECK drains may be either area drains or linear drains. Refer to MAHC 4.8.1.3 for DECK drain area and other requirements.

4.11.4.4 Rinse Showers RINSE SHOWER drains shall discharge to the sanitary or storm sewer as allowed by the AHJ and according to applicable plumbing CODES.

4.11.5 Sanitary Wastes

4.11.5.1 Discharged Wastewater from all PLUMBING FIXTURES in the entire AQUATIC FACILITY shall be discharged to a municipal sanitary sewer system, if available.

4.11.5.2 Onsite Sewer System If a municipal sanitary sewer system is not available, all wastewater shall be disposed to an onsite sewer system that is properly designed to receive the entire wastewater capacity.

4.11.6^A Pool Wastewater

4.11.6.1 Discharged Wastewater from an AQUATIC VENUE, including filter backwash water, shall be discharged to a sanitary sewer system having sufficient capacity to collect and treat wastewater or to an onsite sewage disposal system designed for this purpose.

4.11.6.1.1 Storm Water Systems and Surface Waters Wastewater shall not be directed to storm water systems or surface waters without appropriate permits from the AHJ or the EPA.

4.11.6.1.2 Recovery and Reuse A water recovery and reuse system may be submitted to the AHJ for review and approval.

4.11.6.2^A Ground Surface If a municipal sanitary sewer system is not available, wastewater from an

AQUATIC VENUE may be discharged to the ground surface at a suitable location as approved by the AHJ.

4.11.6.2.1 Discharged Wastewater discharged in this manner shall not cause erosion or create a threat to public health or SAFETY, a nuisance, or unlawful pollution of public waters.

4.11.6.3 Capacity The wastewater disposal system shall have sufficient capacity to receive wastewater without flooding when filters are cleaned or when the AQUATIC VENUE is drained.

4.11.6.4^A Separation Tank for Precoat Media Filters A separation tank shall be provided prior to discharge for backwash water from precoat filters using diatomaceous earth (*DE*) as a filter medium.

4.11.6.4.1 Discharged For precoat filters using perlite or cellulose as a filter medium, the backwash may be discharged to the sanitary sewer, unless directed otherwise by the AHJ.

4.12 Specific Aquatic Venues

4.12.1 Spas

4.12.1.1 Additional Provisions In addition to the general AQUATIC VENUE requirements stated in this CODE, SPAS shall comply with the additional provisions or reliefs of this section.

4.12.1.2^A Maximum Water Depth The maximum water depth in SPAS shall be 4 feet (*1.2 m*) measured from the designed static water line except for SPAS that are designed for SPECIAL USE and purposes and approved by the AHJ.

4.12.1.2.1 Exercise Spas The water depth for exercise SPAS shall not exceed 6 feet 6 inches (*2.0 m*) measured from the designed static water line.

4.12.1.2.2 Seating The maximum submerged depth of any seat or sitting bench shall be 28 inches (*71.1 cm*) measured from the water line.

4.12.1.3^A Handholds A SPA shall have one or more suitable, SLIP-RESISTANT handhold(s) around the perimeter and not over 12 inches (*30.5 cm*) above the water line.

4.12.1.3.1 Options The handhold(s) may consist of bull-nosed coping, ledges, or DECKS along the immediate top edge of the SPA; ladders, steps, or seat ledges; or railings.

4.12.1.4 Stairs Interior steps or stairs shall be provided where SPA depths are greater than 24 inches (*61.0 cm*).

4.12.1.4.1 Handrail Each set of steps shall be provided with at least one handrail to serve all treads and risers.

4.12.1.4.2 Seating Seats or benches may be provided as part of these steps.

4.12.1.4.3 Approach Steps Approach steps on the exterior of a SPA wall extending above the DECK shall also be required unless the raised SPA wall is 19 inches (*48.3 cm*) or less in height above the DECK and it is used as a transfer tier or pivot-seated entry.

4.12.1.5^A Perimeter Deck A 4 foot (*1.2 m*) wide, continuous, unobstructed PERIMETER DECK shall be provided on two consecutive or adjacent sides or fifty percent or more of the SPA perimeter.

4.12.1.5.1 Lower Ratio The AHJ could consider a lower ratio upon review of an appropriate SAFETY PLAN that addresses adequate access.

4.12.1.5.2 Coping The PERIMETER DECK may include the coping.

4.12.1.5.3 Recessed SPAS may be located adjacent to other AQUATIC VENUES as long as they are recessed in the DECK.

4.12.1.5.4^A Elevated Spas Elevated SPAS may be located adjacent to another AQUATIC VENUE as

long as there is an effective BARRIER between the SPA and the adjacent AQUATIC VENUE.

4.12.1.5.5 *Minimum Distance* If an effective BARRIER is not provided, a minimum distance of 4 feet (1.2 m) between the AQUATIC VENUE and SPA is required.

4.12.1.6 **Depth Markers** A minimum of two depth markers shall be provided regardless of the shape or size of the SPA.

4.12.1.7^A **Temperature** Water temperatures shall not exceed 104°F (40°C).

4.12.1.8 **Drain** A means to drain the SPA shall be provided to allow frequent draining and cleaning.

4.12.1.9 **Air Induction System** An air induction system, when provided, shall prevent water back up that could cause electrical shock hazards.

4.12.1.9.1 *Intake* Air intake sources shall not permit the introduction of toxic fumes or other CONTAMINANTS.

4.12.1.10^A **Timers** The hydrotherapy jet system shall be connected to a minute timer that does not exceed 15 minutes to limit the period of agitation.

4.12.1.10.1 *Out of Bather Reach* The hydrotherapy jet system shall be connected to a minute timer located out of reach of a BATHER in the SPA.

4.12.1.11^A **Emergency Shutoff** All SPAS shall have a clearly labeled emergency shutoff or control switch for the purpose of stopping the motor(s) that provide power to the RECIRCULATION SYSTEM and hydrotherapy or hydrotherapy jet system.

4.12.1.11.1 *Readily Accessible* All SPAS shall have a clearly labeled emergency shutoff or control switch that shall be installed and be readily accessible to the BATHERS, in accordance with the NEC.

4.12.2 Waterslides and Landing Pools

4.12.2.1^A Design and Construction

4.12.2.1.1 *Additional Provisions* In addition to the general AQUATIC FACILITY requirements stated in this CODE, WATERSLIDES and LANDING POOLS shall comply with the additional provisions or reliefs of this section.

4.12.2.1.2 *Recognized Standards* The following recognized design and construction STANDARDS for WATERSLIDES shall be adhered to.

4.12.2.1.2.1 **Engineer Compliance** The DESIGN PROFESSIONAL shall provide documentation and/or certification that the WATERSLIDE design is in conformance with these STANDARDS:

- 1) ASTM F2376-17a *Standard Practice for Classification, Design, Manufacture, Construction, and Operation of Water Slide Systems* and
- 2) ASTM F2461-16e1. *Standard Practice for Manufacturer, Construction, Operation, and Maintenance of Aquatic Play Equipment.*

4.12.2.1.2.2 **Required Signage** Signs indicating riding instructions, warnings, and requirements in accordance with the manufacturer recommendations shall be posted at the WATERSLIDE entry.

4.12.2.2 Flumes

4.12.2.2.1 *Surfaces* FLUME surfaces shall be inert, nontoxic, smooth, and easily cleaned.

4.12.2.2.2 *Dips* All FLUME VALLEYS and DIPS shall have proper drainage, SAFETY measures that ensure a rider cannot fall from the FLUME, and a means of egress in the event the ride malfunctions or a rider stops on the ride.

4.12.2.3 Flume Exits

4.12.2.3.1 Landing Pool The exit of any FLUME shall be designed to ensure that BATHERS enter the LANDING POOL or SLIDE RUNOUT at a safe speed and angle of entry.

4.12.2.3.2 Intersection If a WATERSLIDE has two or more FLUMES and there is a point of intersection between the centerlines of any two FLUMES, the distance between that point and the point of exit for each intersecting FLUME shall not be less than the SLIDE manufacturer's recommendations and ASTM F2376.

4.12.2.4^A Exit into Landing Pools

4.12.2.4.1 Water Level WATERSLIDES shall be designed to terminate at or below water level, except for DROP SLIDES or unless otherwise permitted by the WATERSLIDE manufacturer and ASTM F2376.

4.12.2.4.2 Perpendicular WATERSLIDES shall be perpendicular to the wall of the AQUATIC VENUE at the point of exit unless otherwise permitted by the WATERSLIDE manufacturer.

4.12.2.4.3 Exit System WATERSLIDES shall be designed with an exit system which shall be in accordance with the WATERSLIDE manufacturer's recommendations and ASTM F2376.

4.12.2.4.3.1 Safe Entry WATERSLIDES shall be designed with an exit system which shall provide safe entry into the LANDING POOL or WATERSLIDE RUNOUT.

4.12.2.4.4 Flume Exits The FLUME exits shall be in accordance with the WATERSLIDE manufacturer's recommendations and ASTM F2376.

4.12.2.4.5 Point of Exit The distance between the point of exit and the side of the AQUATIC VENUE opposite the BATHERS as they exit, excluding any steps, shall not be less than the WATERSLIDE manufacturer's recommendations and in accordance with ASTM F2376.

4.12.2.5 Landing Pools

4.12.2.5.1 Steps If steps are provided instead of exit ladders or RECESSED STEPS with grab rails, they shall be installed at the opposite end of the LANDING POOL from the FLUME exit with a handrail.

4.12.2.5.2 Landing Area If the WATERSLIDE FLUME ends in a swimming POOL, the landing area shall be divided from the rest of the AQUATIC VENUE by a ROPE AND FLOAT LINE, WING WALL, PENINSULA, or other similar feature to prevent collisions with other BATHERS.

4.12.2.6 Decks A PERIMETER DECK shall be provided along the exit side of the LANDING POOL.

4.12.2.7 Means of Access A walkway, steps, stairway, or ramp shall be provided between the LANDING POOL and the top of the FLUME. Refer to MAHC 4.8.1 for more guidance on DECK spaces.

4.12.2.8 Slide Runouts

4.12.2.8.1 Egress WATERSLIDE RUNOUTS, if used, shall have a planned means of egress, unless one of the walls of the RUNOUT is not more than 19 inches (48.3 cm) in height.

4.12.2.8.2 Designed WATERSLIDE RUNOUTS shall be designed in accordance with the SLIDE manufacturer's recommendations and ASTM F2376.

4.12.2.9^A Drop Slides

4.12.2.9.1 Landing Area There shall be a SLIDE landing area in accordance with the SLIDE manufacturer's recommendations and ASTM F2376.

4.12.2.9.2 Area Clearance This area shall not infringe on the landing area for any other SLIDES, diving equipment, or any other minimum AQUATIC VENUE clearance requirements.

4.12.2.9.3 Steps Steps shall not infringe on this area.

4.12.2.9.4 **Water Depth** The minimum required water depth shall be a function of the vertical distance between the terminus of the SLIDE surface and the water surface of the LANDING POOL.

4.12.2.9.5 **Manufacturer's Recommendation** The minimum required water depth shall be in accordance with the SLIDE manufacturer's recommendations and ASTM F2376.

4.12.2.10 **Pool Slides**

4.12.2.10.1 **Designed for Safety** All SLIDES installed as an appurtenance to an AQUATIC VENUE shall be designed, constructed, and installed to provide a safe environment for all BATHERS utilizing the AQUATIC VENUE in accordance with applicable ASTM and CPSC STANDARDS.

4.12.2.10.2 **Non-Toxic** Components used to construct a POOL SLIDE shall be non-toxic and compatible with the environment contacted under normal use.

4.12.2.10.3 **Water Depth** Water depth at the SLIDE terminus shall be determined by the SLIDE manufacturer.

4.12.2.10.4 **Pool Edge** Clear space shall be maintained to the POOL edge and other features per manufacturer requirements.

4.12.2.10.4.1 **Landing Area** The landing area of the SLIDE shall be protected through the use of a ROPE AND FLOAT LINE, WING WALL, PENINSULA, or other similar impediment to prevent collisions with other BATHERS.

4.12.2.10.4.2 **Prevent Bather Access** Netting or other BARRIERS shall be provided to prevent BATHER access underneath POOL SLIDES where sufficient clearance is not provided.

4.12.2.10.4.3 **Netting or Barrier** Such netting or other BARRIER shall be designed such that any underwater opening does not allow for the passage of a 4 inch (10.2 cm) ball and no opening can create a finger entrapment.

4.12.2.11 **Signage** Warning signs in accordance with manufacturer's recommendations shall be provided.

4.12.3^A **Wave Pools**

4.12.3.1 **General**

4.12.3.1.1 **Additional Provisions** In addition to the general swimming POOL requirements stated in this CODE, WAVE POOLS shall comply with the additional provisions or reliefs of this section.

4.12.3.2 **Access**

4.12.3.2.1 **Access Point** BATHERS shall gain access to the WAVE POOL at the shallow or beach end with the exception of an allowable ADA designated entry point.

4.12.3.2.1.1 **Sides** The sides of the WAVE POOL shall be protected from unauthorized entry into the WAVE POOL by the use of a BARRIER.

4.12.3.2.1.2 **Handrails** Handrails as required by ADA for accessible entries shall be designed in such a way that they do not present a potential for injury or entrapment with WAVE POOL BATHERS.

4.12.3.2.2 **Perimeter Decks** A PERIMETER DECK shall not be required around 100% of the WAVE POOL perimeter.

4.12.3.2.2.1 **Wave Pool Access** A PERIMETER DECK shall be provided where BATHERS gain access to the WAVE POOL at the shallow or beach end and in locations where access is required for lifeguards.

4.12.3.2.3 **Handholds** WAVE POOLS shall be provided with handholds at the static water level or not more than 6 inches (15.2 cm) above the static water level.

4.12.3.2.3.1 **Continuous** These handholds shall be continuous around the WAVE POOL'S perimeter

with the exception of at the ZERO DEPTH ENTRY, water depths less than 24 inches (61.0 cm), if this area is roped off not allowed for BATHER access.

4.12.3.2.3.2 Self Draining These handholds shall be self-draining.

4.12.3.2.3.3 Flush Handholds shall be installed so that their outer edge is flush with the WAVE POOL wall.

4.12.3.2.3.4 Entangled The design of the handholds shall ensure that body extremities will not become entangled during wave action.

4.12.3.2.4 Steps and Handrails RECESSED STEPS shall not be allowed along the walls of the WAVE POOL due to the entrapment potential.

4.12.3.2.5 Ladders Side wall ladders shall be utilized for egress only.

4.12.3.2.5.1 Placement Side wall ladders shall be placed so they do not project beyond the plane of the wall surface.

4.12.3.2.6 Rope and Float Line WAVE POOLS shall be fitted with a ROPE AND FLOAT LINE located to restrict access to the caisson wall if required by the WAVE POOL equipment manufacturer.

4.12.3.2.6.1 Exception ROPE AND FLOAT LINE shall not apply to WAVE POOLS as indicated in provisions of MAHC 4.5.19.5.3.

4.12.3.3 Safety

4.12.3.3.1 Life Jackets Proper STORAGE shall be provided for life jackets and all other equipment used in the WAVE POOL that will allow for thorough drying to prevent mold and other biological growth.

4.12.3.3.2 Shut-Off Switch A minimum of two emergency shut-off switches to disable the wave action shall be provided, one on each side of the WAVE POOL.

4.12.3.3.2.1 Labeled and Accessible These switches shall be clearly labeled and readily accessible to QUALIFIED LIFEGUARDS.

4.12.3.3.3 Caisson Enclosure Caisson ENCLOSURES that prevent the passage of a 4-inch (10.2 cm) ball shall be provided for all WAVE POOLS.

4.12.4 Therapy Pools

4.12.4.1 Additional Provisions In addition to the general AQUATIC VENUE requirements stated in this CODE, THERAPY POOLS shall comply with the additional provisions or reliefs of this section and MAHC 4.7.3.3 on SECONDARY TREATMENT.

4.12.4.2 Slope Floor slope may exceed 1 foot (30.5 cm) in 12 feet (3.7 m) for water shallower than 5 feet (1.5 m).

4.12.4.2.1 Break Points Break points in floor slope shall be identified with a contrasting band consistent with MAHC 4.5.4.2.

4.12.4.3 Hydrotherapy Hydrotherapy jet systems shall be independent of the recirculation, filtration, and heating systems.

4.12.4.4 Special Equipment Special equipment may be allowed by the AHJ with proper justification.

4.12.5 Lazy Rivers

4.12.5.1 General

4.12.5.1.1 Additional Provisions In addition to the general swimming AQUATIC VENUE requirements stated in this CODE, LAZY RIVERS shall comply with the additional provisions or reliefs of this section.

4.12.5.1.2 *Protrusions* Handrails, steps, stairs, and propulsion jets for LAZY RIVERS shall not protrude into the river.

4.12.5.2 Access and Egress

4.12.5.2.1^A *Means* Means of access/egress shall be provided at 150 foot (45.7 m) intervals around the LAZY RIVER.

4.12.5.2.2^A *Handhold* A handhold in compliance with MAHC 4.5.14 shall be required on at least one side of the LAZY RIVER but shall not include horizontal bars and/or recessed handholds.

4.12.5.2.2.1 *Bathers In or On Tubes Exception:* Handholds shall not be required where BATHERS are required to be in or on a tube while in the LAZY RIVER.

4.12.5.2.3^A *Deck* A DECK shall be provided along the entire length of the LAZY RIVER.

4.12.5.2.3.1 *Alternate Sides* The DECK shall be allowed to alternate sides of the LAZY RIVER.

4.12.5.2.3.2 *Obstructions* Obstructions around the perimeter of the LAZY RIVER, such as bridges or landscaping, shall be allowed provided they do not impact lifeguarding, sight lines, or rescue operations.

4.12.5.2.4^A *Bridges* All bridges spanning a LAZY RIVER shall have a minimum clearance of both 7 feet (2.1 m) from the bottom of the LAZY RIVER and 4 feet (1.2 m) above the water surface to any structure overhead.

4.12.6 Moveable Floors

4.12.6.1 General

4.12.6.1.1 *Additional Provisions* In addition to the general swimming AQUATIC VENUE requirements stated in this CODE, MOVEABLE FLOORS shall comply with the additional provisions or reliefs of this section.

4.12.6.1.2 *Water Treatment* The MOVEABLE FLOOR design shall not impede the effectiveness of the water treatment system.

4.12.6.1.3 *Underneath* MOVEABLE FLOORS shall allow inspection, cleaning, and maintenance of the area underneath.

4.12.6.2 *Slip Resistant* The surface of the MOVEABLE FLOOR shall be SLIP RESISTANT if it is intended for installation in water depths less than 5 feet (1.5 m).

4.12.6.3 Safety

4.12.6.3.1^A *Not Continuous* A strategy for preventing BATHERS from transitioning to deeper water when a MOVEABLE FLOOR is not continuous over the entire surface area of the AQUATIC VENUE shall be provided.

4.12.6.3.2^A *Underside* The underside of the MOVEABLE FLOOR shall not be accessible to BATHERS.

4.12.6.3.3 *Entrapment* The design of a MOVEABLE FLOOR shall protect against BATHER entrapment between the MOVEABLE FLOOR and the POOL walls and floor.

4.12.6.3.4 *Hydraulic Fluid* If the MOVEABLE FLOOR is operated using hydraulics, the hydraulic compounds shall be listed as safe for use in POOL water in case there is a hydraulic leak.

4.12.6.4^A Movement

4.12.6.4.1 *Speed* The speed of a MOVEABLE FLOOR shall be less than or equal to 1.5 feet per minute (45.7 cm/min).

4.12.6.4.2 *Use* Use of the MOVEABLE FLOOR portion of the POOL shall not be open to BATHERS when the floor is being raised or lowered.

4.12.6.4.2.1 Accessibility Exception: The MOVEABLE FLOOR shall only be used for accessibility purposes under direct supervision.

4.12.6.5 Water Depth and Markings

4.12.6.5.1 Displayed A floor depth indicator shall be provided that displays the current POOL water depth.

4.12.6.5.2 Warning Markings Warning markings stating “Moveable Floor” shall be provided at 25 foot (7.6 m) intervals around the perimeter of the MOVEABLE FLOOR.

4.12.7 Bulkheads

4.12.7.1 Additional Provisions In addition to the general AQUATIC VENUE requirements stated in this CODE, BULKHEADS shall comply with the additional provisions or reliefs of this section.

4.12.7.2^A Entrapment The bottom of the BULKHEAD shall be designed so that a BATHER cannot be entrapped underneath or inside of the BULKHEAD.

4.12.7.3 Placement The BULKHEAD placement shall not interfere with the required water circulation in the POOL.

4.12.7.4 Fixed BULKHEADS shall be fixed to their operational position(s) by a tamper-proof system.

4.12.7.5^A Gap The gap between the BULKHEAD and the POOL wall shall be no greater than 1.5 inches (3.8 cm).

4.12.7.6^A Handhold The BULKHEAD shall be designed to afford an acceptable handhold as required in MAHC 4.5.14.

4.12.7.7 Entrances and Exits The proper number of entrances/exits to the POOL as required by MAHC 4.5.3 shall be provided when the BULKHEAD is in place.

4.12.7.8 Guard Railings Guard railings at least 34 inches (86.4 cm) tall shall be provided on both ends of the BULKHEAD.

4.12.7.9^A Width The width of the walkable area (*total BULKHEAD width*) of a BULKHEAD shall be greater than or equal to 3 feet and 3 inches (1.0 m).

4.12.7.9.1^A Starting Platforms If starting platforms are installed, the width of the walkable area (*total BULKHEAD width*) of a BULKHEAD shall be greater than or equal to 3 feet and 9 inches (1.1 m).

4.12.7.9.1.1 Side Mount Style Starting platforms shall be “side mount” style if BULKHEAD is less than 4 feet 6 inches (1.4 m) wide.

4.12.7.10 Bulkhead Travel The travel of a BULKHEAD shall be in accordance with one of the following:

- 1) Limited such that it cannot encroach on any required clearances of other features, such as diving boards, or
- 2) Designed with modifications incorporated that prevent use of other features when the required clearances have been compromised by the position of the BULKHEAD.

4.12.7.11 Bulkhead Installation BULKHEADS shall not be installed, unless designed, and operated in accordance with all manufacturer’s installation and operations recommendations.

4.12.8^A Interactive Water Play Venues

4.12.8.1 Additional Provisions In addition to the general AQUATIC VENUE requirements stated in this CODE, INTERACTIVE WATER PLAY VENUES shall comply with the additional provisions or reliefs of this

section.

4.12.8.2 Surface INTERACTIVE WATER PLAY VENUES shall have a SLIP-RESISTANT and easily cleaned surface.

4.12.8.2.1 Manufactured Surfacing Any manufactured surfacing shall be deemed suitable by the manufacturer for aquatic and chlorinated environments.

4.12.8.3^A Sloped The INTERACTIVE WATER PLAY VENUE shall be properly sloped so that only water from the AQUATIC FEATURES flows back to the INTERACTIVE WATER PLAY VENUE collection tank.

4.12.8.3.1 Adjacent Areas Areas adjacent to the INTERACTIVE WATER PLAY VENUE shall be sloped away from the collection drains.

4.12.8.3.2 Water Collection The slope of the INTERACTIVE WATER PLAY VENUE shall be sufficient to prevent standing water from collecting on the pad.

4.12.8.4 Drains The size, number and locations of the INTERACTIVE WATER PLAY VENUE drains shall be determined and specified so as to assure water does not accumulate on the INTERACTIVE WATER PLAY VENUES.

4.12.8.4.1 Gravity Flow through the drains to the INTERACTIVE WATER PLAY VENUE COLLECTION TANK shall be under gravity.

4.12.8.4.2 Direct Suction Outlets Direct suction outlets from the INTERACTIVE WATER PLAY VENUE shall be prohibited.

4.12.8.4.3 Valving Valves shall be provided in the drain system to allow for discharging water to an approved means for wastewater disposal prior to returning to the collection tank when INTERACTIVE WATER PLAY AQUATIC VENUE is not operational.

4.12.8.5 Grate Openings Openings in the grates covering the drains shall not exceed ½ inches (12.7 mm) wide.

4.12.8.5.1 Tools Gratings shall not be removable without the use of tools.

4.12.8.6 Treatment Tank The INTERACTIVE WATER PLAY VENUE COLLECTION TANK shall be designed to provide ready access for cleaning and inspections, and

4.12.8.6.1 Completely Drain The INTERACTIVE WATER PLAY VENUE collection tank shall be capable of complete draining.

4.12.8.6.2 Access Hatch The access hatch or lid shall be locked or require a tool to open.

4.12.8.6.3 Capacity The collection tank shall have a minimum operational volume of 3,000 gallons of water.

4.12.8.6.3.1 Volume The volume of water in the collection tank shall be sufficient to assure continuous operation of the filtration system.

4.12.8.6.4 Overflow Pipe A means to convey excess water in the tank to an AHJ approved waste disposal system shall be provided.

4.12.8.6.5^A Inlets RECIRCULATION SYSTEM INLETS shall be sized and positioned to provide for complete mixing in the tank.

4.12.8.7 Deck Area INTERACTIVE WATER PLAY VENUES shall be kept free of landscape debris by either:

- 1) Eight feet (2.4 m) of DECK area,
- 2) Raised curbs, or

3) Raised planters.

4.12.8.7.1 Deck Surface The DECK shall be of a uniform, easily cleaned, impervious material.

4.12.8.7.2 Protected From Runoff The DECK shall be protected from surface runoff.

4.12.8.8 Barrier A BARRIER shall be provided to separate an INTERACTIVE WATER PLAY VENUE from another BODY OF WATER within the same facility.

4.12.8.8.1 Exception: Separated by Distance Exception: The INTERACTIVE WATER PLAY VENUE is separated by a distance of at least 15 feet (4.6 m) from other bodies of water.

4.12.8.9 Enclosures If a facility only consists of an INTERACTIVE WATER PLAY VENUE, then the requirements for an ENCLOSURE shall not apply.

4.12.8.10^A Hazard Spray features shall be designed and installed to be seen clearly, so as not to be a hazard to BATHERS due to water velocity from the spray feature discharge, or other SAFETY hazards.

4.12.8.11 Maximum Velocity Maximum velocity at the orifice of the spray feature nozzle shall not exceed 20 feet (6.1 m) per second.

4.12.8.12^A Signage Depth markings and warning signs shall not be required for INTERACTIVE WATER PLAY VENUES.

4.12.8.13 NEC Requirements NEC swimming POOL requirements shall apply to INTERACTIVE WATER PLAY VENUES.

4.12.9 Wading Pools

4.12.9.1 Additional Provisions In addition to the general AQUATIC VENUE requirements stated in this CODE, WADING POOLS shall comply with the additional provisions or reliefs of this section.

4.12.9.2^A Barrier A BARRIER shall be provided to separate a WADING POOL from other POOLS unless the WADING POOL is separated by a distance of 15 feet (4.6 m) from other BODIES OF WATER.

4.12.9.2.1 Complete Barrier The BARRIER shall not be required to completely surround the WADING POOL if the shortest distance of travel between the WADING POOL around the BARRIER to the other POOL is a minimum of 15 feet (4.67 m).

4.12.9.2.2^A Shallow Water WADING POOLS near other WADING POOLS shall not be required to be separated by a BARRIER.

4.12.10^A Other Aquatic Features Other AQUATIC FEATURES not otherwise addressed in the CODE, including but not limited to climbing walls, inflatables, and play structures, shall not be installed unless designed and operated in accordance with all manufacturer's installation and operations recommendations.

5.0 Aquatic Facility Operation and Maintenance

The provisions of Chapter 5 apply to all AQUATIC FACILITIES covered by this CODE regardless of when constructed, unless otherwise noted.

Note: Section numbers with superscript “A” (*e.g.*, 5.0^A) denote a corresponding discussion in the Annex to the Model Aquatic Health Code.

5.1 Operating Permits

5.1.1 Owner Responsibilities

5.1.1.1 Permit to Operate Required Prior to opening to the public, the AQUATIC FACILITY owner shall apply to the AHJ for a permit to operate.

5.1.1.2 Separate A separate permit is required for each newly constructed or SUBSTANTIALLY ALTERED AQUATIC VENUE at an existing AQUATIC FACILITY.

5.1.1.3 Prior to Issuance Before a permit to operate is issued, the following procedures shall be completed:

- 1) The AQUATIC FACILITY owner has demonstrated the AQUATIC FACILITY, including all newly constructed or SUBSTANTIALLY ALTERED AQUATIC VENUES, is in compliance with the requirements of this CODE, and
- 2) The AHJ has approved the AQUATIC FACILITY to be open to the public.

5.1.1.4 Permit Details The permit to operate shall:

- 1) Be issued in the name of the owner,
- 2) List all AQUATIC VENUES included under the permit, and
- 3) Specify the period of time approved by the AHJ.

5.1.1.5 Permit Expiration Permits to operate shall terminate according to the AHJ schedule.

5.1.1.6 Permit Renewal The AQUATIC FACILITY owner shall renew the permit to operate prior to the scheduled expiration of an existing permit to operate an AQUATIC FACILITY.

5.1.1.7 Permit Denial The permit to operate may be withheld, revoked, or denied by the AHJ for noncompliance of the AQUATIC FACILITY with the requirements of this CODE.

5.1.1.8 Owner Responsibilities The owner of an AQUATIC FACILITY is responsible for the facility being operated, maintained, and managed in accordance with the requirements of this CODE.

5.1.2 Operating Permits

5.1.2.1 Permit Location The permit to operate shall be posted at the AQUATIC FACILITY in a location conspicuous to the public.

5.1.2.2 Operating Without a Permit Operation of an AQUATIC FACILITY or newly constructed or SUBSTANTIALLY ALTERED AQUATIC VENUE without a permit to operate shall be prohibited.

5.1.2.3 Required Closure The AHJ may order a newly constructed or SUBSTANTIALLY ALTERED AQUATIC VENUE without a permit to operate to close until the AQUATIC FACILITY has obtained a permit to operate.

5.2 Inspections

5.2.1 Preoperational Inspections

5.2.1.1 Terms of Operation The AQUATIC FACILITY may not be placed in operation until an inspection approved by the AHJ shows compliance with the requirements of this CODE or the AHJ approves

opening for operation.

5.2.2 Exemptions

5.2.2.1 Applying for Exemption An AQUATIC FACILITY seeking an initial exemption or an existing AQUATIC FACILITY claiming to be exempt according to applicable regulations shall contact the AHJ for application details/forms.

5.2.2.2 Change in Exemption Status An AQUATIC FACILITY that sought and received an exemption from a public regulation shall contact the AHJ if the conditions upon which the exemption was granted change so as to eliminate the exemption status.

5.2.3^A Variances

5.2.3.1 Variance Authority The AHJ may grant a variance to the requirements of this CODE.

5.2.3.2 Applying for a Variance An AQUATIC FACILITY seeking a variance shall apply in writing with the appropriate forms to the AHJ.

5.2.3.2.1 Application Components The application shall include, but not be limited to:

- 1) A citation of the CODE section to which the variance is requested,
- 2) A statement as to why the applicant is unable to comply with the CODE section to which the variance is requested,
- 3) The nature and duration of the variance requested,
- 4) A statement of how the intent of the CODE will be met and the reasons why the public health or SAFETY would not be jeopardized if the variance was granted, and
- 5) A full description of any policies, procedures, or equipment that the applicant proposes to use to rectify any potential increase in health or SAFETY risks created by granting the variance.

5.2.3.3 Revoked Each variance shall be revoked when the permit attached to it is revoked.

5.2.3.4 Not Transferable A variance shall not be transferable unless otherwise provided in writing at the time the variance is granted.

5.3 Equipment Standards [N/A]

5.4 Aquatic Facility and Venue Operation and Maintenance

5.4.1 Closure and Reopening

5.4.1.1^A Closure If an AQUATIC VENUE is not open to the public, the following conditions shall be met to protect health and SAFETY:

5.4.1.1.1 Aquatic Venues With an Enclosure

Where the AQUATIC VENUE has an ENCLOSURE enclosing it per MAHC 4.8.6:

- 1) The water shall be recirculated and treated to meet the criteria of this CODE;
- 2) The water shall be drained;
- 3) An approved safety cover that is CERTIFIED, LISTED, AND LABELED to ASTM F1346-91 by an ANSI-accredited certification organization shall be installed; or
- 4) Where a safety cover is not used or not practical, access to the AQUATIC VENUE shall be restricted and routine checks of the integrity of the AQUATIC VENUE ENCLOSURE shall be made.

5.4.1.1.2 Aquatic Venues Without an Enclosure but Open to the Public Where the

AQUATIC VENUE does not have an ENCLOSURE enclosing it per MAHC 4.8.6 and other parts of the AQUATIC FACILITY are open to the public:

- 1) The water shall be recirculated and treated to meet the criteria of this CODE and the AQUATIC VENUE shall be staffed to keep BATHERS out;
- 2) The water shall be drained, and the AQUATIC VENUE shall be staffed to keep BATHERS out;
- 3) A temporary BARRIER for the AQUATIC VENUE shall be installed to keep bathers out, and routine checks of the integrity of the temporary AQUATIC VENUE BARRIER shall be made; or
- 4) An approved safety cover that is CERTIFIED, LISTED, AND LABELED to ASTM F1346-91 by an ANSI-accredited certification organization shall be installed.

5.4.1.1.3 Aquatic Venues Without an Enclosure and Closed to the Public Where the aquatic venue does not have an enclosure enclosing it per MAHC 4.8.6, and the aquatic facility is closed to the public:

- 1) The water shall be recirculated and treated to meet the criteria of this CODE;
- 2) The water shall be drained;
- 3) An approved safety cover CERTIFIED, LISTED, AND LABELED to ASTM F1346-91 by an ANSI-accredited certification organization shall be installed; or
- 4) Where a safety cover is not used or not practical, access to the AQUATIC FACILITY shall be restricted and routine checks of the integrity of the AQUATIC FACILITY ENCLOSURE shall be made.

5.4.1.2^A Reopening An owner or operator of a closed AQUATIC VENUE shall verify that the AQUATIC VENUE meets all applicable criteria of this CODE before reopening the AQUATIC VENUE.

5.4.2^A Preventive Maintenance Plan

5.4.2.1 Written Plan

5.4.2.1.1 Preventive Maintenance Plan Available A written comprehensive preventive maintenance plan for each AQUATIC VENUE shall be available at the AQUATIC FACILITY.

5.4.2.1.2 Contents The AQUATIC FACILITY preventive maintenance plan shall include details and frequency of owner/operator's planned routine facility inspection, maintenance, and replacement of recirculation and water treatment components.

5.4.2.2^A Facility Documentation

5.4.2.2.1 Original Plans and Specifications Available A copy of the approved plans and specifications for each AQUATIC VENUE constructed after the adoption of this CODE shall be available at the AQUATIC FACILITY

5.4.2.2.2 Equipment Inventory A comprehensive inventory of all mechanical equipment associated with each AQUATIC VENUE shall be available at the AQUATIC FACILITY.

5.4.2.2.3 Inventory Details This inventory shall include:

- 1) Equipment name and model number;
- 2) Manufacturer and contact information;
- 3) Local vendor/supplier and technical representative, if applicable; and
- 4) Replacement or service dates and details.

5.4.2.2.4 Equipment Manuals Operation manuals for all mechanical equipment associated with each AQUATIC VENUE shall be available at the AQUATIC FACILITY.

5.4.2.2.4.1 *No Manual* If no manufacturer's operation manual is available, then the AQUATIC FACILITY shall create a written document that outlines STANDARD operating procedures for maintaining and operating the piece of equipment.

5.4.3 General Operations [N/A]

5.4.3.1 *Theoretical Peak Occupancy* The THEORETICAL PEAK OCCUPANCY per MAHC 4.1.2.3.5 shall not be exceeded.

5.5 Aquatic Venue Structure

5.5.1 Shape [N/A]

5.5.2 Access Ladders

5.5.2.1 *Securely Anchored* Ladders, grab rails, and handrails shall be securely anchored.

5.5.3 Color and Finish [N/A]

5.5.4 Walls [N/A]

5.5.5^A Depth Markings

5.5.5.1 *Depth Markers* Depth markers shall be provided in locations in accordance with MAHC 4.5.19 and maintained.

5.5.5.2 *No Diving Markers* NO DIVING MARKERS shall be provided in accordance with MAHC 4.5.19 and maintained.

5.5.5.3 *Ropes and Float Lines* ROPES AND FLOAT LINES shall be installed as required in 4.5.19.5.3, 4.12.2.5.2, 4.12.2.10.4.1, and 4.12.3.2.6.

5.5.6^A Pool Shell Maintenance

5.5.6.1 Cracking

5.5.6.1.1 *Repaired* CRACKS shall be part of the daily inspection process and be repaired when they change sufficiently to increase the potential for:

- 1) Leakage,
- 2) Trips or falls,
- 3) Lacerations, or
- 4) Impact the ability to properly clean and maintain the AQUATIC VENUE area.

5.5.6.1.2 *Document Cracks* Surface CRACKS under 1/8 inch (3.2 mm) wide shall be documented and MONITORED for any movement or change including opening, closing, and/or lengthening.

5.5.6.1.3 *Sharp Edges* Any sharp edges shall be removed or repaired.

5.6 Indoor / Outdoor Environment

5.6.1 Lighting

5.6.1.1 Lighting Maintained

5.6.1.1.1^A *Light Levels* Lighting systems, including emergency lighting, shall be maintained in all PATRON areas and maintenance areas, to ensure the required lighting levels are met as specified in MAHC 4.6.1.

5.6.1.1.2^A *Main Drain Visible* The AQUATIC VENUE shall not be open if light levels are such that

the main drain is not visible from poolside.

5.6.1.1.2.1 With an Enclosure The AQUATIC FACILITY may remain open for other events if the closed AQUATIC VENUE has an ENCLOSURE.

5.6.1.1.3^A Underwater Lighting Underwater lights, where provided, shall be operational and maintained as designed.

5.6.1.1.3.1 Ground-Fault Circuit Interrupter Branch circuits that supply underwater lights operating at more than the Low Voltage Contact Limit as defined in NEC 680.2 shall be GFCI protected.

5.6.1.1.3.2 Unprotected Light Circuit Operation of an unprotected underwater light circuit shall be prohibited.

5.6.1.1.4 Cracked Lenses CRACKED lenses that are physically intact on lights shall be replaced before the AQUATIC VENUE reopens to BATHERS.

5.6.1.1.5 Intact Lenses The AQUATIC VENUE shall be immediately closed if CRACKED lenses are not intact and the lenses shall be replaced before reopening.

5.6.1.2^A Glare

5.6.1.2.1^A Assessments The AQUATIC FACILITY owner shall ensure that glare conditions are assessed to determine if the AQUATIC VENUE bottom and objects in the POOL are clearly visible throughout operating hours.

5.6.1.2.1.1^A Lifeguard Positions If the AQUATIC VENUE requires lifeguards, the AQUATIC FACILITY owner shall ensure that glare conditions are assessed from each lifeguard position as identified in the zone of PATRON surveillance to determine if the AQUATIC VENUE bottom and objects in the POOL are clearly visible to QUALIFIED LIFEGUARD staff throughout operating hours per MAHC 6.3.3.1.1.

5.6.1.2.2 Reduction Windows and lighting equipment shall be adjusted, if possible, to minimize glare and excessive reflection on the water surface.

5.6.1.3 Night Swimming Night swimming shall be prohibited unless required light levels in accordance with MAHC 4.6.1 are provided.

5.6.1.3.1 Hours Night swimming shall be considered one half hour before sunset to one half hour after sunrise.

5.6.1.4 Emergency Lighting Emergency lighting shall be tested and maintained according to manufacturer's recommendations.

5.6.2^A Indoor Aquatic Facility Ventilation

5.6.2.1 Purpose AIR HANDLING SYSTEMS shall be maintained and operated by the owner/operator to protect the health and SAFETY of the facility's PATRONS.

5.6.2.2 Original Characteristics AIR HANDLING SYSTEMS shall be maintained and operated to comply with all requirements of the original system design, construction, and installation.

5.6.2.3 Indoor Facility Areas The AIR HANDLING SYSTEM operation and maintenance requirements shall apply to an INDOOR AQUATIC FACILITY including the AQUATIC VENUES, and the surrounding BATHER and spectator/STADIUM SEATING area.

5.6.2.3.1 Does Not Include The AIR HANDLING SYSTEM operation and maintenance requirements does not include:

- 1) Mechanical rooms,
- 2) Bath and locker rooms, and
- 3) Any associated rooms which have a direct opening to the AQUATIC FACILITY.

5.6.2.4 Ventilation Procedures THE INDOOR AQUATIC FACILITY owner/operator shall develop and implement a program of STANDARD AIR HANDLING SYSTEM operation, maintenance, cleaning, testing, and inspection procedures with detailed instructions, necessary equipment and supplies, and oversight for those carrying out these duties, in accordance with the AIR HANDLING SYSTEM DESIGN PROFESSIONAL and/or manufacturer's recommendations.

5.6.2.4.1 System Operation The AIR HANDLING SYSTEM shall operate continuously, including providing the required amount of outdoor air.

5.6.2.4.1.1 Operation Outside of Operating Hours Exception During non-use periods, the amount of outdoor air may be reduced by no more than 50% as long as acceptable air quality is maintained.

5.6.2.5 Manuals/Commissioning Reports The QUALIFIED OPERATOR shall maintain a copy of the AIR HANDLING SYSTEM DESIGN PROFESSIONAL and/or manufacturer original operating manuals, commissioning reports, updates, and specifications for any modifications at the facility.

5.6.2.6 Ventilation Monitoring The QUALIFIED OPERATOR shall MONITOR, log, and maintain AIR HANDLING SYSTEM set-points and other operational parameters as specified by the AIR HANDLING SYSTEM DESIGN PROFESSIONAL and/or manufacturer.

5.6.2.7 Air Filter Changing The QUALIFIED OPERATOR shall replace or clean, as appropriate, AIR HANDLING SYSTEM air filters in accordance with the AIR HANDLING SYSTEM DESIGN PROFESSIONAL and/or manufacturer's recommendations, whichever is most frequent.

5.6.2.8^A Combined Chlorine Reduction The QUALIFIED OPERATOR shall develop and implement a plan to minimize COMBINED CHLORINE compounds in the INDOOR AQUATIC FACILITY from the operation of AQUATIC VENUES.

5.6.2.9 Building Purge Plan The QUALIFIED OPERATOR shall develop and implement an air quality action plan with procedures for PURGING the INDOOR AQUATIC FACILITY for chemical emergencies or other indicators of poor air quality.

5.6.2.10 Records The owner shall ensure documents are maintained at the INDOOR AQUATIC FACILITY to be available for inspection, recording the following:

- 1) A log recording the set points of operational parameters set during the commissioning of the AIR HANDLING SYSTEM and the actual readings taken at least once daily;
- 2) Maintenance conducted to the system including the dates of filter changes, cleaning, and repairs;
- 3) Dates and details of modifications to the AIR HANDLING SYSTEM; and
- 4) Dates and details of modifications to the operating scheme.

5.6.3 Indoor / Outdoor Aquatic Facility Electrical Systems and Components

5.6.3.1^A Electrical Repairs

5.6.3.1.1 Code Compliance Repairs or alterations to electrical equipment and associated equipment shall preserve compliance with the NEC or with all applicable local, state, territorial, federal, and tribal laws.

5.6.3.1.2 Immediately Repaired All defects in the electrical system shall be immediately repaired.

5.6.3.1.3 Wiring Electrical wiring, whether permanent or temporary, shall comply with the NEC and all applicable local, state, territorial, federal, and tribal laws.

5.6.3.2^A Electrical Receptacles

5.6.3.2.1 New Receptacles The installation of new electrical receptacles shall be subject to electrical-construction requirements of this CODE and all applicable local, state, territorial, federal, and tribal

laws.

5.6.3.2.2 *Repairs* Repairs or maintenance to existing receptacles shall maintain compliance with the NEC and with 29 CFR 1910.304(b) (3) (ii).

5.6.3.2.3 *Replacement* Replacement receptacles shall be of the same type as the previous ones (e.g., *grounding-type receptacles shall be replaced only by grounding-type receptacles*), with all grounding conductors connected and proper wiring polarity preserved.

5.6.3.2.4 *Substitutions* Where the original-type of receptacle is no longer available, a replacement and installation shall be in accordance with all applicable local, state, territorial, federal, and tribal laws.

5.6.3.3^A Ground-Fault Circuit Interrupter

5.6.3.3.1 *Manufacturer's Recommendations* Where receptacles are required to be protected by GFCI devices, the GFCI devices shall be tested following the manufacturer's recommendations.

5.6.3.3.2 *Testing* Required GFCI devices shall be tested as part of scheduled maintenance on the first day of operation, and monthly thereafter, until the BODY OF WATER is drained and the equipment is prepared for STORAGE.

5.6.3.4^A Grounding

5.6.3.4.1 *Maintenance and Repair* Maintenance or repair of electrical circuits or devices shall preserve grounding compliance with the NEC and all applicable local, state, territorial, federal, and tribal laws.

5.6.3.4.2 *Grounding Conductors* Grounding conductors that have been disconnected shall be re-inspected as required by the local building CODE authority prior to AQUATIC VENUE being used by BATHERS.

5.6.3.4.3 *Damaged Conductors* Damaged grounding conductors and grounding electrodes shall be repaired immediately.

5.6.3.4.4 *Damaged Conductor Repair* Damaged grounding conductors or grounding electrodes associated with recirculation or DISINFECTION equipment or with underwater lighting systems shall be repaired by a qualified person who has the proper and/or necessary skills, training, or credentials to carry out the task.

5.6.3.4.5 *Public Access* The public shall not have access to the AQUATIC VENUE until such grounding conductors or grounding electrodes are repaired.

5.6.3.4.6 *Venue Closure* The AQUATIC VENUE with damaged grounding conductors or grounding electrodes, that are associated with recirculation or DISINFECTION equipment or with underwater lighting systems, shall be closed until repairs are completed and then the AHJ inspects and approves.

5.6.3.5 Bonding

5.6.3.5.1 *Code Compliance* Maintenance or repair of all metallic equipment, electrical circuits or devices, or reinforced concrete structures shall preserve bonding compliance with the NEC and all applicable local, state, territorial, federal, and tribal laws.

5.6.3.5.2 *Bonding Conductors* Bonding conductors shall not be disconnected except where they will be immediately reconnected.

5.6.3.5.3 *Disconnected Conductors* The AQUATIC VENUE shall not be used by BATHERS while bonding conductors are disconnected.

5.6.3.5.4 *Removable Covers* Removable covers protecting bonding conductors (e.g., *at ladders*), shall be kept in place except during bonding conductor inspections, repair, or replacement.

5.6.3.5.5 *Scheduled Maintenance* Bonding conductors, where accessible, shall be inspected visually every 6 months or whenever disrupted or impacted by site construction or other related events.

5.6.3.5.6 *Corrosion* Bonding conductors and any associated clamps shall not be extensively corroded.

5.6.3.5.7 *Continuity* Continuity of the bonding system associated with RECIRCULATION SYSTEM or DISINFECTION equipment or with underwater lighting systems shall be inspected by the AHJ following installation and any major construction around the AQUATIC FACILITY.

5.6.3.6 Extension Cords

5.6.3.6.1 *Extension Cords and Temporary Connectors*

Extension cords shall only be used temporarily for remodeling, maintenance, or repair of buildings, structures, or equipment with similar purposes. Extension cords and temporary power connectors shall not be used as a substitute for permanent wiring.

5.6.3.6.2 *Minimum Distance from Water* All parts of an extension cord shall be restrained at a minimum of 6 feet (1.8 m) away when measured along the shortest possible path from a BODY OF WATER during times when the AQUATIC FACILITY is open.

5.6.3.6.3^A *Exception* An extension cord may be used within 6 feet (1.8 m) of the nearest edge of a BODY OF WATER if a permanent wall exists between the BODY OF WATER and the extension cord.

5.6.3.6.4 *GFCI Protection* The circuit supplying an extension cord shall be protected by a GFCI device when the extension cord is to be used within 6 feet (1.8 m) of a BODY OF WATER.

5.6.3.6.5 *Code Compliance* An extension cord incorporating a GFCI device may be used if that is acceptable under all applicable local, state, territorial, federal, and tribal laws.

5.6.3.6.6^A *Compliance* The use of extension cords shall comply with 29 CFR 1910.304.

5.6.3.7 *Portable Electric Devices* Portable line-powered electrical devices, such as radios or drills, shall not be used within 6 feet (1.8 m) horizontally of the nearest inner edge of a BODY OF WATER, unless connected to a GFCI-protected circuit.

5.6.3.8^A *Communication Devices and Dispatch Systems* The maintenance and repair of Communication Devices and Dispatch Systems shall preserve compliance with the NEC.

5.6.4 Facility Heating

5.6.4.1 Facility Heating

5.6.4.1.1^A *Maintenance and Repair* Maintenance, repairs, and alterations to facility-heating equipment shall preserve compliance with applicable CODES.

5.6.4.1.2^A *Defects* Defects in the AQUATIC FACILITY heating equipment shall be immediately repaired.

5.6.4.1.3^A *Temperature* Air temperature of an INDOOR AQUATIC FACILITY shall be controlled to the original specifications or in the absence of such, maintain the dew point of the INTERIOR SPACE less than the dew point of the interior walls at all times so as to prevent damage to structural members and to prevent biological growth on walls.

5.6.4.1.4 *Combustion Device* Items shall not be stored within the COMBUSTION DEVICE manufacturer's specified minimum clearance distance.

5.6.4.2 *Water Heating* Maintenance, repairs, and alterations to POOL-water heating equipment shall

preserve compliance with applicable CODES.

5.6.5 First Aid Room [N/A]

5.6.6 Emergency Exit

5.6.6.1 Exit Routes Emergency exit routes shall be established for both INDOOR AQUATIC FACILITIES and outdoor AQUATIC FACILITIES and be maintained so that they are well lit, unobstructed, and accessible at all times. Emergency exits shall be clearly marked in accordance with MAHC 4.6.6.

5.6.7 Plumbing

5.6.7.1^A Water Supply

5.6.7.1.1 Water Pressure All plumbing shall be maintained in good repair with no leaks or discharge.

5.6.7.1.2 Availability Potable water shall be available at all times to PATRONS.

5.6.7.1.3 Cross-Connection Control Water introduced into the POOL, either directly or to the RECIRCULATION SYSTEM, shall be supplied through an air gap or by another method which will prevent BACKFLOW and back-siphonage.

5.6.7.2 Drinking Fountains

5.6.7.2.1 Good Repair Drinking fountains shall be in good repair.

5.6.7.2.2 Clean Drinking fountains shall be clean.

5.6.7.2.3 Catch Basin Drinking fountains shall be adjusted so that water does not go outside the catch basin.

5.6.7.2.4 Contamination Drinking fountains shall provide an angled jet of water and be adjusted so that the water does not fall back into the drinking water stream.

5.6.7.2.5 Water Pressure Drinking fountains shall have sufficient water pressure to allow correct adjustment.

5.6.7.3^A Wastewater

5.6.7.3.1 Wastewater Disposal AQUATIC VENUE wastewater, including backwash water and cartridge cleaning water, shall be disposed of in accordance with all applicable local, state, territorial, federal, and tribal laws.

5.6.7.3.2 Drainage Wastewater and backwash water shall not be returned to an AQUATIC VENUE or the AQUATIC FACILITY'S water treatment system.

5.6.7.3.3 Drain Line Filter backwash lines, DECK drains, and other drain lines connected to the AQUATIC FACILITY or the AQUATIC FACILITY RECIRCULATION SYSTEM shall be discharged through an approved air gap.

5.6.7.3.4 No Standing Water Discharge water shall not create any standing water, a nuisance, offensive odors, stagnant wet areas, or an environment for the breeding of insects.

5.6.7.4^A Water Replenishment

5.6.7.4.1 Volume Removal of water from the POOL and replacement with make-up water shall be performed as needed to maintain water quality.

5.6.7.4.2 Discharged A volume of water totaling at least 4 gallons (15 L) per BATHER per day per AQUATIC VENUE shall be either:

1) Discharged from the system, or

2) Treated with an alternate system meeting the requirements of MAHC 4.7.4 and reused.

5.6.7.4.2.1 Backwash Water The required volume of water to be discharged may include backwash water.

5.6.7.4.3 Multi-System Facilities In multi-RECIRCULATION SYSTEM facilities, water replenishment shall be proportional to the number of BATHERS in each system.

5.6.8 Solid Waste Management

5.6.8.1 Storage Receptacles

5.6.8.1.1 Good Repair and Clean Outside waste and recycling containers shall be maintained in good repair and clean condition.

5.6.8.1.2 Storage Areas Outside waste and recycling STORAGE areas shall be maintained in good repair and clean condition.

5.6.8.2 Disposal

5.6.8.2.1 Frequency Solid waste and recycled materials shall be removed at a frequency to prevent attracting vectors or causing odor.

5.6.8.2.2 Code Compliance Solid waste and recycled materials shall be disposed of in compliance with all applicable local, state, territorial, federal, and tribal laws.

5.6.9 Decks

5.6.9.1 Food Preparation and Consumption

5.6.9.1.1 Preparation Food preparation and cooking shall only be permitted in designated areas as specified in this CODE.

5.6.9.1.2^A Eating and Drinking BATHERS shall not eat or drink while in or partially in the AQUATIC VENUE water except in designated areas.

5.6.9.1.2.1 Swim-Up Bars Swim-up bars, when utilized, shall provide facilities for BATHERS to place food and drinks on a surface which can be SANITIZED.

5.6.9.2^A Glass

5.6.9.2.1 Containers Glass food and beverage containers shall be prohibited in PATRON areas of AQUATIC FACILITIES.

5.6.9.2.2 Furniture Glass furniture shall not be used in an AQUATIC FACILITY.

5.6.9.3 Deck Maintenance

5.6.9.3.1^A Free From Obstructions The PERIMETER DECK shall be maintained free from obstructions, including PATRON seating, to preserve space required for lifesaving and rescue.

5.6.9.3.2 Diaper Changing Diaper changing shall only be done at a designated DIAPER-CHANGING STATION.

5.6.9.3.2.1 Prohibited Diaper changing shall be prohibited on the DECK.

5.6.9.3.3^A Vermin DECK areas shall be cleaned daily and kept free of debris, vermin, and vermin harborage.

5.6.9.3.4^A Original Design DECK surfaces shall be maintained to their original design slope and integrity.

5.6.9.3.4.1^A Crack Repair CRACKS in the DECK shall be part of the daily inspection process and be repaired when they change sufficiently to increase the potential for:

- 1) Trips or falls,
- 2) Lacerations, or
- 3) Impacting the ability to properly clean and maintain the DECK area.

5.6.9.3.5 *Standing Water* DECK areas shall be free from standing water.

5.6.9.3.6 *Drains* DECK drains shall be cleaned and maintained to prevent blockage and pooling of water.

5.6.9.3.7 *Wet Areas* Wet areas shall not have absorbent materials that cannot be removed for cleaning and DISINFECTION daily.

5.6.9.3.8 *Circulation Path* Fixed equipment, loose equipment, and DECK furniture shall not intrude upon the AQUATIC VENUE CIRCULATION PATH.

5.6.10 Aquatic Facility Maintenance All appurtenances, features, signage, and safety and other equipment and systems required by this CODE shall be provided and maintained.

5.6.10.1^A Diving Boards and Platforms

5.6.10.1.1 *Slip Resistant Finish* The finish and profile of surfaces of diving boards and platforms shall be maintained to prevent slips, trips, and falls.

5.6.10.1.2 *Loose Bolts and Cracked Boards* Diving boards shall be inspected daily for CRACKS and loose bolts with CRACKED boards removed and loose bolts tightened immediately.

5.6.10.2 Steps and Guardrails

5.6.10.2.1 *Immovable* Steps and guardrails shall be secured so as not to move during use.

5.6.10.2.2 *Maintenance* The profile and surface of steps shall be maintained to reduce the likelihood of slips and falls.

5.6.10.3^A Starting Platforms The profile and surface of starting platform steps shall be in good repair to prevent slips, trips, falls, and pinch hazards.

5.6.10.3.1 *Starting Platform Use Deterrence* Starting platform use by unqualified BATHERS shall be prohibited and prohibition shall be communicated by signage, covers, or other BARRIERS or deterrents.

5.6.10.4 Aquatic Features

5.6.10.4.1 *Maintenance* AQUATIC FEATURES shall be maintained and operated to manufacturer's/designer's specifications.

5.6.10.4.2 *Slime and Biofilm* Slime and biofilm layers shall be removed on all accessible AQUATIC FEATURE surfaces.

5.6.10.4.3 *Flow Rates* AQUATIC FEATURE water flow rates shall be checked to be within designer or manufacturer's specifications prior to opening to the public.

5.6.10.4.4 *Disinfectant* Where AQUATIC FEATURE plumbing lines are susceptible to holding stagnant water, AQUATIC FEATURE pumps shall be started with sufficient time prior to opening to flush such plumbing lines with treated water.

5.6.10.4.4.1 *Water Testing* The water shall be tested to verify the disinfectant in the water is within the parameters specified in MAHC 5.7.3.1.1.2.

5.6.10.5^A Fencing, Enclosures, and Barriers

5.6.10.5.1 *Maintenance* Required fencing, ENCLOSURES, BARRIERS, and gates shall be maintained at all times.

5.6.10.5.2 *Tested Daily* Gates, locks, and associated alarms, if required, shall be tested daily prior to opening.

5.6.10.6^A Aquatic Facility Cleaning

5.6.10.6.1 *Cleaning* The AQUATIC VENUE shall be kept clean of debris, organic materials, and slime/biofilm in accessible areas in the water and on surfaces.

5.6.10.6.2 *Vacuumping* Vacuuming shall only be done when the AQUATIC VENUE is closed.

5.6.10.6.3 *Port Openings* Vacuum port openings shall be covered with an approved device cover when not in use.

5.6.10.6.3.1 *Damaged* POOLS with missing or damaged vacuum port openings shall be closed and repairs made before reopening.

5.7 Recirculation and Water Treatment

5.7.1 Recirculation Systems and Equipment

5.7.1.1^A General

5.7.1.1.1 *Continuous Operation* All components of the filtration and RECIRCULATION SYSTEMS shall be kept in continuous operation 24 hours per day.

5.7.1.1.1.1 *Reduced Flowrates* The system flowrate shall not be reduced more than 25% lower than the minimum design requirements and only reduced when the POOL is unoccupied during posted closure hours of the AQUATIC VENUE.

5.7.1.1.1.1.1 *System Design* The flow turndown system shall be designed as specified in MAHC 4.7.1.10.5.1–4.7.1.10.5.2.

5.7.1.1.1.1.2 *Water Clarity* The system flowrate shall be based on ensuring the minimum water clarity required under MAHC 5.7.6 is met before opening to the public.

5.7.1.1.1.2 *Disinfectant Concentration* The turndown system shall be required to maintain required disinfectant concentration and pH at all times.

5.7.1.1.2 *Flow* Flow through the various components of a RECIRCULATION SYSTEM shall be balanced according to the provisions outlined in MAHC 5.7.1 to maximize the water clarity and SAFETY of a POOL.

5.7.1.1.3^A *Gutter / Skimmer Pools* For gutter or SKIMMER POOLS with main drains, the required recirculation flow shall be the total design recirculation flow rate divided as follows during normal operation:

- 1) At least 80% of the total design recirculation flow rate through the Perimeter Overflow System, and
- 2) No greater than 20% of the total design recirculation flow rate through the main drain.

5.7.1.2 *Combined Venue Treatment* Each individual AQUATIC VENUE in a combined treatment system shall meet required TURNOVER TIMES specified in MAHC 5.7.1.9 and achieve all water quality criteria (including, but not limited to, pH, disinfectant concentration, and water clarity/turbidity).

5.7.1.3^A *Inlets* INLETS shall be checked at least weekly for rate and direction of flow and adjusted as necessary to produce uniform circulation of water and to facilitate the maintenance of a uniform disinfectant residual throughout the POOL.

5.7.1.4 Surface Skimming Devices

5.7.1.4.1 *Perimeter Overflow* The Perimeter Overflow System shall be kept clean and free of debris that may restrict flow.

5.7.1.4.2 *Automatic Fill System* The automatic fill system, when installed, shall maintain the

water level at an elevation such that the gutters must overflow continuously around the perimeter of the POOL.

5.7.1.4.3 Skimmer Water Levels The water levels shall be maintained near the middle of the SKIMMER openings.

5.7.1.4.4 Flow The flow through each SKIMMER shall be adjusted to maintain skimming action that will remove all floating matter from the surface of the water.

5.7.1.4.5 Strainer Baskets The strainer baskets for SKIMMERS shall be cleaned as necessary to maintain proper skimming.

5.7.1.4.6 Weirs Weirs shall remain in place and in working condition at all times.

5.7.1.4.6.1 Broken or Missing Weirs Broken or missing SKIMMER weirs shall be replaced immediately.

5.7.1.4.7 Flotation Test A flotation test may be required by the AHJ to evaluate the effectiveness of surface skimming.

5.7.1.5 Submerged Drains/Suction Outlet Covers or Gratings

5.7.1.5.1 Replaced Loose, broken, or missing suction outlet covers and sumps shall be secured or replaced immediately and installed in accordance with the manufacturer's requirements.

5.7.1.5.1.1 Closed POOLS shall be closed until the required repairs can be completed.

5.7.1.5.1.2 Close/Open Procedures AQUATIC FACILITIES shall follow procedures for closing and reopening whenever required as outlined in MAHC 5.4.1.

5.7.1.5.2 Documentation The manufacturer's documentation on all outlet covers and sumps shall be made part of the permanent records of the AQUATIC FACILITY.

5.7.1.6^A Piping Piping shall be marked in accordance with MAHC 4.9.1.5.1 and 4.9.1.5.2.

5.7.1.7 Strainers & Pumps Strainers shall be in place and cleaned as required to maintain pump performance.

5.7.1.8^A Flow Meters Flow meters in accordance with MAHC 4.7.1.9.1 shall be provided and maintained in proper working order.

5.7.1.9 Flow Rates / Turnovers

5.7.1.9.1 New Construction or Substantially Altered Venues AQUATIC VENUES constructed or substantially altered after the adoption of this CODE shall be operated at the designed flow rate to provide the required TURNOVER RATE 24-hours per day except as allowed in MAHC 4.7.1.10.

5.7.1.9.2 Construction Before Adoption of this Code AQUATIC VENUES constructed before the adoption of this CODE shall be operated 24 hours per day at their designed flow rate.

5.7.2 Filtration

5.7.2.1 General

5.7.2.1.1 Certified, Listed, and Labeled Filters and filter media shall be CERTIFIED, LISTED, AND LABELED to NSF/ANSI 50 by an ANSI-accredited certification organization.

5.7.2.1.2 Cleaned Filters shall be backwashed, cleaned, and maintained according to the manufacturer's instructions.

5.7.2.2 Granular Media Filters

5.7.2.2.1 Filtration Rates High-rate granular media filters shall be operated at no more than 15 GPM per square foot (36.7 m/h) when a minimum bed depth of 15 inches (38.1 cm) is provided per

manufacturer's instructions.

5.7.2.2.1.1 Less than Fifteen Inch Bed Depth When a bed depth is less than 15 inches (38.1 cm), filters shall operate at no more than 12 GPM per square foot (29.3 m/h). Bed depth shall be measured from the top of the filter media to the top of the openings in the laterals (or underdrain system).

5.7.2.2.2 Backwashing Rates The granular media filter system shall be backwashed at a rate of at least 15 GPM per square foot (36.7 m/h) of filter bed surface area unless explicitly prohibited by the filter manufacturer and/or approved at an alternate rate as specified in the NSF/ANSI 50 listing as per MAHC 4.7.2.2.3.2.

5.7.2.2.3 Clear Water Backwashing should be continued until the water leaving the filter is clear.

5.7.2.2.4^A Backwashing Frequency Backwashing of each filter shall be performed at a differential pressure increase over the initial clean filter pressure, as recommended by the filter manufacturer, unless the system can no longer achieve the design flow rate.

5.7.2.2.4.1^A Backwash Scheduling Backwashes shall be scheduled to take place when the AQUATIC VENUE is closed for BATHER use.

5.7.2.2.4.1.1 Backwashing Without Bathers Present BATHERS shall not be permitted to reenter the AQUATIC VENUE until the RESPONSIBLE SUPERVISOR or QUALIFIED OPERATOR ensures that the recirculation pump and chemical feeders have restarted and run for a minimum of 5 minutes following completion of backwashing.

5.7.2.2.4.1.2 Backwashing With Bathers Present A filter may be backwashed while BATHERS are in the AQUATIC VENUE if all of the following criteria are met:

- 1) Multiple filters are used;
- 2) The filter to be backwashed can be isolated from the remaining RECIRCULATION SYSTEM and filters;
- 3) The recirculation and filtration system still continues to run as per this CODE;
- 4) The chemical feed lines inject at a point where chemicals enter the RECIRCULATION SYSTEM after the isolated filter and where they can mix as needed; and
- 5) The filtrate from the newly backwashed filter is diverted to a waste line for a time sufficient to pass one filter volume of water through the filter.

5.7.2.2.5 Filter Media Inspections Sand or other granular media shall be inspected for proper depth and cleanliness at least one time per year, replacing the media when necessary to restore depth or cleanliness.

5.7.2.2.6 Vacuum Sand Filters The manual air release valve of the filter shall be opened as necessary to remove any air that collects inside of the filter as well as following each backwash.

5.7.2.2.7^A Filtration Enhancing Products Products used to enhance filter performance shall be used according to manufacturers' recommendations.

5.7.2.3 Precoat Filters

5.7.2.3.1 Appropriate The appropriate media type and quantity as recommended by the filter manufacturer shall be used.

5.7.2.3.2^A Return to the Aquatic Venue Precoating of the filters shall be required in closed loop (precoat) mode to minimize the potential for media or debris to be returned to the POOL.

5.7.2.3.3^A Operation Filter operation shall be per manufacturer's instructions.

5.7.2.3.3.1 Uninterrupted Flow Flow through the filter shall not be interrupted when switching from precoat mode to filtration mode unless the filters are CERTIFIED, LISTED, AND LABELED to NSF/ANSI 50 by an ANSI-accredited certification organization to return water to the POOL during the precoat process.

5.7.2.3.3.1.1 Flow Interruption When a flow interruption occurs on precoat filters not designed to bump, the media shall be backwashed out of the filter and a new precoat established according to the manufacturer's recommendations prior to BATHERS reentering the POOL.

5.7.2.3.3.2 Maximum Precoat Media Load Systems designed to flow to waste while precoating shall use the maximum recommended precoat media load permitted by the filter manufacturer to account for media lost to the waste stream during precoating.

5.7.2.3.4^A Cleaning Backwashing or cleaning of filters shall be performed at a differential pressure increase over the initial clean filter pressure as recommended by the filter manufacturer unless the system can no longer achieve the design flow rate.

5.7.2.3.5 Continuous Feed Equipment Continuous filter media feed equipment tank agitators shall run continuously.

5.7.2.3.5.1 Batch Application Filter media feed may also be performed via batch application.

5.7.2.3.6^A Bumping Bumping a precoat filter shall be performed in accordance with the manufacturer's recommendations.

5.7.2.3.7^A Filter Media

5.7.2.3.7.1^A Diatomaceous Earth Diatomaceous earth (*DE*), when used, shall be added to precoat filters in the amount recommended by the filter manufacturer.

5.7.2.3.7.2 Perlite Perlite, when used, shall be added to precoat filters in the amount recommended by the filter manufacturer and in accordance with the specifications for the filter listing and labeling to NSF/ANSI 50 by an ANSI-accredited certification organization.

5.7.2.4 Cartridge Filters

5.7.2.4.1^A Approved Cartridge filters shall be operated in accordance with the filter manufacturer's recommendation and be CERTIFIED, LISTED, AND LABELED to NSF/ANSI 50 by an ANSI-accredited certification organization.

5.7.2.4.2^A Filtration Rates The maximum operating filtration rate for any surface-type cartridge filter shall not:

- 1) Exceed the lesser of either the manufacturer's recommended filtration rate or 0.375 GPM per square foot ($0.26 L/s/m^2$) or
- 2) Drop below the design flow rate required to achieve the TURNOVER RATE for the AQUATIC VENUE.

5.7.2.4.3^A Filter Elements Active filter cartridges shall be exchanged with clean filter cartridges at a differential pressure increase over the initial clean filter pressure as recommended by the filter manufacturer unless the system can no longer achieve the design flow rate.

5.7.2.4.3.1^A Cleaning Procedure The filter housing and filter cartridge shall be cleaned per manufacturer's recommendation.

5.7.2.4.3.1.1 No Manufacturer Procedure If there is no established manufacturer cleaning procedure, then filters shall be cleaned per MAHC 5.7.2.4.3.2 and 5.7.2.4.3.3.

5.7.2.4.3.2 Filter Housing Cleaning The following procedures shall be implemented to clean the filter housing when no manufacturer instructions are established:

- 1) Drain filter housing to waste;
- 2) Remove the filter cartridges from the housing;
- 3) Clean the inside of the filter housing with a brush and mild detergent to remove biofilms and algae;
- 4) Rinse thoroughly; and

5) Mist the filter housing walls with CHLORINE bleach at a 1:10 dilution.

5.7.2.4.3.3 Filter Cartridge Cleaning The following procedures shall be implemented to clean the filter cartridge when no manufacturer instructions are established.

5.7.2.4.3.3.1 Rinse Thoroughly The cartridge shall be rinsed thoroughly with a spray nozzle.

5.7.2.4.3.3.2^A Pressure Washer A pressure washer shall not be used to clean cartridge filters.

5.7.2.4.3.3.3 Degrease Cartridge filters shall be degreased each time they are cleaned per the procedures outlined in this section.

5.7.2.4.3.3.4 Soak The cartridge shall be soaked overnight in one of the following solutions:

- 1) A cartridge filter cleaner/degreaser per instructions on product label,
- 2) A solution of water with 1 cup (240 mL) of tri-sodium phosphate (TSP) per 5 gallons (18.9 L) of water, or
- 3) One cup (240 mL) of automatic dishwashing detergent per 5 gallons (18.9 L) of water.

5.7.2.4.3.3.5 Acid Muriatic acid or products with acid in them shall never be used prior to degreasing.

5.7.2.4.3.3.6 Rinse The filter cartridge shall be removed from the degreaser solution and rinsed thoroughly.

5.7.2.4.3.3.7 Sanitize The filter cartridge shall be SANITIZED by soaking for 1 hour in a bleach solution made by mixing 1 quart (950 mL) of household bleach per 5 gallons (18.9 L) of water.

5.7.2.4.3.3.8 Rinse After soaking for 1 hour, the SANITIZED filter cartridge shall be removed and rinsed thoroughly.

5.7.2.4.4 Spare Cartridge One full set of spare cartridges shall be maintained onsite in a clean and dry condition.

5.7.3^A Water Treatment Chemicals and Systems

Treatment chemicals shall be CERTIFIED, LISTED, AND LABELED to either NSF/ANSI 50 or NSF/ANSI 60 by an ANSI-accredited certification organization, and/or have an EPA FIFRA registration and be used only in accordance with the manufacturer's instructions.

5.7.3.1 Primary Disinfectants Only the primary disinfectants outlined in MAHC 5.7.3 shall be acceptable for use in AQUATIC VENUES.

5.7.3.1.1^A Chlorine (Hypochlorites)

5.7.3.1.1.1 EPA Registered Only CHLORINE products that are EPA REGISTERED for use as SANITIZERS or disinfectants in AQUATIC VENUES or SPAS in the United States shall be permitted.

5.7.3.1.1.2^A Minimum DPD-FC Concentrations Minimum DPD-FC concentrations shall be maintained at all times in all areas as follows in MAHC 5.7.3.1.1.2.1 to 5.7.3.1.1.2.3.

5.7.3.1.1.2.1 Not Using Cyanuric Acid AQUATIC VENUES *not* using CYA shall maintain a minimum DPD-FC concentration of 1.0 ppm (mg/L).

5.7.3.1.1.2.2 Using Cyanuric Acid AQUATIC VENUES using CYA shall maintain a minimum DPD-FC concentration of 2.0 ppm (mg/L).

5.7.3.1.1.2.3 Spas SPAS shall maintain a minimum DPD-FC concentration of 3.0 ppm (mg/L).

5.7.3.1.1.3 Stagnant Water Lines Recirculated AQUATIC FEATURE water lines susceptible to holding stagnant water shall maintain disinfectant throughout the lines as per MAHC 5.7.3.1.1.2.

5.7.3.1.1.4 Consistent with Label Instructions DPD-FC concentrations shall be consistent with label instructions.

5.7.3.1.1.5^A Maximum DPD-FC Concentrations Maximum DPD-FC concentrations shall not exceed 10.0 ppm (*mg/L*) at any time the AQUATIC VENUE is open to BATHERS.

5.7.3.1.2 Bromine

5.7.3.1.2.1^A EPA Registered Only bromine products that are EPA REGISTERED for use as SANITIZERS or disinfectants in AQUATIC VENUES or SPAS in the United States shall be permitted.

5.7.3.1.2.1.1 Disinfectants Bromine-based disinfectants may be applied to AQUATIC VENUES and SPAS through the addition of an organic bromine compound (1,3-Dibromo-5,5-dimethylhydantoin (DBDMH) or 1-bromo-3-chloro-5,5-dimethylhydantoin (BCDMH)).

5.7.3.1.2.2^A Minimum Bromine Concentrations Minimum bromine concentrations shall be maintained at all times in all areas as follows:

- 1) All AQUATIC VENUES: 3.0 ppm (*mg/L*), and
- 2) SPAS: 4.00 ppm (*mg/L*).

5.7.3.1.2.3^A Maximum Bromine Concentrations The maximum bromine concentration shall not exceed 8.0 ppm (*mg/L*) at any time the AQUATIC VENUE is open to BATHERS.

5.7.3.1.3 Stabilizers CYA or stabilized CHLORINE products shall be CERTIFIED, LISTED, AND LABELED to either NSF/ANSI 50 or NSF/ANSI 60 by an ANSI-accredited certification organization, and/or have an EPA FIFRA registration.

5.7.3.1.3.1^A Cyanuric Acid CYA or stabilized CHLORINE products shall ***not*** be used at the following for all new construction, SUBSTANTIAL ALTERATION, or DISINFECTION equipment replacements after the effective date of this CODE:

- 1) SPAS and
- 2) Therapy pools.

5.7.3.1.3.1.1 Replacement Times These AQUATIC VENUES shall no longer use CYA or stabilized CHLORINE products no later than 4 years after adoption of this CODE.

5.7.3.1.3.2 Aquatic Venues The CYA level at all AQUATIC VENUES shall remain at or below 90 ppm (*mg/L*).

5.7.3.1.4^A Compressed Chlorine Gas As per MAHC 4.7.3.2.4.1, use of compressed CHLORINE gas shall be prohibited for new construction and after SUBSTANTIAL ALTERATION to existing AQUATIC FACILITIES.

5.7.3.1.4.1 Safety Requirements Facilities using compressed CHLORINE gas shall provide SAFETY precautions per the following MAHC subsections.

5.7.3.1.4.1.1 Separate Enclosure The chlorinators and any cylinders containing CHLORINE gas used therewith shall be housed in an ENCLOSURE separated from other EQUIPMENT ROOMS, including the swimming POOL, corridors, dressing rooms and other space.

5.7.3.1.4.1.1.1 Door The chlorinators and any cylinders containing CHLORINE gas used therewith shall be housed in an ENCLOSURE with a door so installed as to prevent gas leakage and equipped with an inspection window.

5.7.3.1.4.1.2 Secured CHLORINE cylinders shall be secured from falling.

5.7.3.1.4.1.3 Cylinders in Use Cylinders in use shall be secured on a suitable platform

scale.

5.7.3.1.4.1.4 Vent to Exterior A separate vent opening to the exterior shall be provided.

5.7.3.1.4.1.5 Fan An electric motor-driven fan shall take suction from near the floor level of the ENCLOSURE and discharge at a suitable point to the exterior above the ground level.

5.7.3.1.4.1.5.1 Fan Switch The fan switch shall be able to be operated from outside of the ENCLOSURE.

5.7.3.1.4.1.6 Trained Operator Any person who operates such chlorinating equipment shall be trained in its use.

5.7.3.1.4.1.7 Stop Use Facilities shall stop the use of CHLORINE gas if specific safety equipment and training requirements, along with all applicable local, state, territorial, federal, and tribal laws, cannot be met.

5.7.3.1.5^A Salt Electrolytic Chlorine Generators, Brine Electrolytic Chlorine or Bromine Generators

5.7.3.1.5.1 Pool Grade Salt Only POOL grade salt that has been CERTIFIED, LISTED, AND LABELED to either NSF/ANSI 50 or NSF/ANSI 60 by an ANSI-accredited certification organization, and/or have an EPA FIFRA registration shall be used.

5.7.3.1.5.2 Maintained The saline content of the POOL water shall be maintained in the required range specified by the manufacturer.

5.7.3.1.5.3 Cleaning Cleaning of electrolytic plates shall be performed as recommended by the manufacturer.

5.7.3.1.5.4 Corrosion Protection Corrosion protection systems shall be maintained in the POOL basin.

5.7.3.2^A Secondary or Supplemental Treatment Systems

5.7.3.2.1 Ultraviolet Light

5.7.3.2.1.1 Operate with Recirculation System UV systems shall only operate while the RECIRCULATION SYSTEM is operating.

5.7.3.2.1.1.1 Response to Interruption in Operation Any interruptions in UV system operations that are triggered by an interlock per MAHC 4.7.3.2.5.6.2 shall be evaluated as possible evidence for low flow state of the AQUATIC VENUE pumps, prompting BATHER evacuation according to MAHC 5.7.3.5.1.2.1 and BATHER reentry according to MAHC 5.7.3.5.1.2.2.

5.7.3.2.1.2^A Log Inactivation Secondary UV systems shall be operated and maintained not to exceed the maximum validated flow rate and meet or exceed the minimum validated output intensity needed to achieve the required dose.

5.7.3.2.1.3 Free Available Chlorine and Bromine Levels Use of UV does not modify any other water quality requirements.

5.7.3.2.1.4^A Calibrated Sensors UV sensors shall be calibrated at a frequency in accordance with manufacturer recommendations.

5.7.3.2.1.5 Records Records of calibration shall be maintained by the facility.

5.7.3.2.2 Ozone

5.7.3.2.2.1 Log Inactivation Ozone systems shall be operated and maintained according to the manufacturer's instructions to maintain the required design performance.

5.7.3.2.2.2 Residual Ozone Concentration Residual ozone concentration in the AQUATIC VENUE water shall remain below 0.1 ppm (mg/L).

5.7.3.2.2.3 Free Available Chlorine and Bromine Levels Use of ozone does not modify any other water quality requirements.

5.7.3.2.2.4 Standard Operating Manual A printed STANDARD operating manual shall be provided containing information on the operation and maintenance of the ozone generating equipment, including the responsibilities of workers in an emergency.

5.7.3.2.2.5 Employees Trained All employees shall be properly trained in the operation and maintenance of the equipment.

5.7.3.2.2.6 Response to Interruption in Operation Any interruptions in ozone system operations that are triggered by an interlock per MAHC 4.7.3.2.5.6.2 shall be evaluated as possible evidence for low flow state of the AQUATIC VENUE pumps, prompting BATHER evacuation according to MAHC 5.7.3.5.1.2.1 and BATHER reentry according to MAHC 5.7.3.5.1.2.2.

5.7.3.2.3^A Copper / Silver Ions

5.7.3.2.3.1 EPA Registered Only those systems that are EPA REGISTERED for use as SANITIZERS or disinfectants in AQUATIC VENUES or SPAS in the United States are permitted.

5.7.3.2.3.2 Concentrations Copper and silver concentrations shall not exceed 1.3 ppm (*mg/L*) for copper and 0.10 ppm (*mg/L*) for silver for use as disinfectants in AQUATIC VENUES and SPAS in the United States.

5.7.3.2.3.3 DPD-FC and Bromine Concentration Levels DPD-FC or bromine concentrations shall be maintained in accordance with MAHC 5.7.3.1.1 or 5.7.3.1.2, respectively.

5.7.3.3^A Other Sanitizers, Disinfectants, or Chemicals Other SANITIZERS, disinfectants, or chemicals used shall:

- 1) Be EPA REGISTERED under FIFRA if they are pesticides as defined by EPA,
- 2) Not create a hazardous condition or compromise disinfectant efficacy when used with required bromine or CHLORINE concentrations, and
- 3) Not interfere with water quality measures meeting all criteria set forth in this CODE.

5.7.3.3.1^A Chlorine Dioxide CHLORINE dioxide shall only be used for remediation for water quality issues when the AQUATIC VENUE is closed and BATHERS are not present.

5.7.3.3.1.1 Safety Considerations SAFETY training and SAFETY precautions related to use of CHLORINE dioxide shall be in place.

5.7.3.3.2^A Clarifiers, Flocculants, Defoamers Clarifiers, flocculants, and defoamers shall be used per manufacturer's instructions.

5.7.3.3.2.1 Certified, Listed, and Labeled Clarifiers, flocculants, and defoamers shall CERTIFIED, LISTED, AND LABELED to either NSF/ANSI 50 or NSF/ANSI 60 by an ANSI-accredited certification organization, and/or have an EPA FIFRA registration.

5.7.3.4^A pH

5.7.3.4.1 pH Range The pH of the water shall be maintained at 7.0 - 7.8.

5.7.3.4.2 Approved Substances Approved substances for pH adjustment shall include but not be limited to muriatic (*hydrochloric*) acid, sodium bisulfate, carbon dioxide, sulfuric acid, sodium bicarbonate, and soda ash.

5.7.3.4.2.1 Certified, Listed, and Labeled Chemicals used for pH adjustment shall be CERTIFIED, LISTED, AND LABELED to either NSF/ANSI 50 or NSF/ANSI 60 by an ANSI-accredited certification organization, and/or have an EPA FIFRA registration.

5.7.3.5^A Feed Equipment

5.7.3.5.1 Acceptable Chemical Delivery Acceptable disinfectant and pH control chemicals shall be delivered through an automatic chemical feed system upon adoption of this CODE.

5.7.3.5.1.1 Dedicated and Labeled Components All chemical feed system components shall be dedicated to a single chemical and clearly labeled to prevent the introduction of incompatible chemicals.

5.7.3.5.1.2^A Installed and Interlocked Chemical feed system components shall be installed and interlocked so the chemical feeder cannot operate when the RECIRCULATION SYSTEM is in low or no flow circumstances as per MAHC 4.7.3.2.1.3.

5.7.3.5.1.2.1 Response to Alarm and Bather Evacuation When the interlock is activated stopping flow from chemical feeders per MAHC 4.7.3.2.1.3 and 5.7.3.5.1.3, or the water recirculation pump is stopped manually or unexpectedly for any reason and duration, including power outages, all BATHERS shall be evacuated from the AQUATIC VENUE until manual evaluation of the cause for interlock activation or recirculation pump interruption is completed by the RESPONSIBLE SUPERVISOR or QUALIFIED OPERATOR.

5.7.3.5.1.2.2^A Bather Reentry BATHERS shall not be permitted to reenter the AQUATIC VENUE until the RESPONSIBLE SUPERVISOR or QUALIFIED OPERATOR has successfully understood the cause of the interlock activation and/or recirculation pump interruption and has manually overridden the interlock for restart of the recirculation pump and chemical feeder, and UV or ozone system, if applicable, for 5 minutes following the restart of these systems.

5.7.3.5.1.3 Fail Proof Safety Features Chemical feed system components shall incorporate failure-proof features so the chemicals cannot feed directly into the AQUATIC VENUE, the VENUE piping system not associated with the RECIRCULATION SYSTEM, source water supply system, or area within proximity of the AQUATIC VENUE DECK under any type of failure, low flow, or interruption of operation of the equipment to prevent BATHER exposure to high concentrations of AQUATIC VENUE treatment chemicals.

5.7.3.5.1.4 Maintained All chemical feed equipment shall be maintained in good working condition.

5.7.3.5.1.4.1 Challenge Testing The system and its components shall be tested on a regular basis to confirm that all SAFETY features are functioning correctly.

5.7.3.5.1.4.1.1 Once Monthly or Specified by Manufacturer Unless specified otherwise by the device manufacturer, once monthly challenge testing of the chemical feeder interlock system shall be conducted by turning off recirculation pump flow to the chemical feeder and ensuring triggered shutoff of chemical feeder occurs via electrical interlock with flow meter/flow switch, paddle wheel, or other device being used to assess flow to chemical feeder.

5.7.3.5.1.4.1.2 Following Confirmation Following confirmation of triggered shutoff, recirculation flow shall immediately be restarted.

5.7.3.5.1.5 Insufficient Size/Capacity If it is determined that the chemical feed system is incapable of maintaining the minimum required disinfectant level at all times in accordance with the MAHC, additional capacity shall be designed and installed per MAHC 4.7.3.2.2.

5.7.3.5.2 Chemical Feeders Chemical feeders shall be installed such that they are not over chemical storage containers, other feeders, or electrical equipment.

5.7.3.5.3 Dry Chemical Feeders Chemicals shall be kept dry to avoid clumping and potential feeder plugging for mechanical gate or rotating screw feeders.

5.7.3.5.3.1 Cleaned and Lubricated The feeder mechanism shall be cleaned and lubricated to maintain a reliable feed system.

5.7.3.5.4 Venturi Inlet Adequate pressure shall be maintained at the venturi INLET to create the vacuum needed to draw the chemical into the RECIRCULATION SYSTEM.

5.7.3.5.5 **Erosion Feeders** Erosion feeders shall only have chemicals added that are approved by the manufacturer.

5.7.3.5.5.1 **Opened** A feeder shall only be opened after the internal pressure is relieved by a bleed valve.

5.7.3.5.5.2 **Maintained** Erosion feeders shall be maintained according to the manufacturer's instructions.

5.7.3.5.6 **Liquid Solution Feeders** For liquid solution feeders, spare feeder tubes (*or tubing*) shall be maintained onsite for peristaltic pumps.

5.7.3.5.7 **Checked Daily** All chemical tubing, connections, support, and double containment piping shall be checked on a daily basis for leaks.

5.7.3.5.7.1 **Routed** All chemical tubing that runs through areas where staff work shall be routed in PVC piping to support the tubing and to prevent leaks.

5.7.3.5.7.1.1 **Size** The double containment PVC pipe shall be of sufficient size to allow for easy replacement of tubing.

5.7.3.5.7.1.2 **Turns** Any necessary turns in the piping shall be designed so as to prevent kinking of the tubing.

5.7.3.5.8 **Gas Feed Systems** The Chlorine Institute Pamphlet 82 requirements for safe STORAGE and use of CHLORINE gas shall be followed.

5.7.3.5.9 **Carbon Dioxide** Carbon dioxide feed shall be permitted to reduce pH.

5.7.3.5.9.1 **Controlled** Carbon dioxide feed shall be controlled using a gas regulator.

5.7.3.5.9.2 **Alarm Monitor** CO₂/O₂ monitor and alarm shall be maintained in working condition.

5.7.3.5.9.3 **Forced Ventilation** Carbon dioxide is heavier than air, so forced ventilation shall be maintained in the STORAGE room.

5.7.3.6 Testing for Water Circulation and Quality

5.7.3.6.1 **Water Quality Testing Devices Available** WQTDs for the measurement of disinfectant residual, pH, alkalinity, CYA (*if used*), and temperature, at a minimum, shall be available onsite.

5.7.3.6.1.1 **Expiration Dates** WQTDs utilizing reagents shall be checked for expiration at every use and the date recorded.

5.7.3.6.2 **Store** WQTDs shall be stored in accordance with manufacturer's instructions.

5.7.3.6.3 **Temperature** Chemical testing reagents shall be maintained at proper manufacturer specified temperatures.

5.7.3.6.4 **Calibration** WQTDs that require calibration shall be calibrated in accordance with manufacturer's instructions and the date of calibration recorded.

5.7.3.7 Automated Controllers and Equipment Monitoring

5.7.3.7.1 **Use of Controller** An AUTOMATED CONTROLLER capable of measuring the disinfectant residual (*DPD-FC or bromine*) or surrogate such as ORP shall be used to maintain the disinfectant residual in AQUATIC VENUES as outlined in MAHC 4.7.3.2.8.

5.7.3.7.1.1 **Installed** An AUTOMATED CONTROLLER shall be required within 1 year from time of adoption of this CODE.

5.7.3.7.1.2 **Interlocked** AUTOMATED CONTROLLERS shall be interlocked per MAHC 4.7.3.2.1.3

upon adoption of this CODE if existing or upon installation if not existing.

5.7.3.7.2 **Sampling** The sample line for all probes shall be upstream from all primary, SECONDARY and SUPPLEMENTAL TREATMENT injection ports or devices.

5.7.3.7.3 **Monitor** AUTOMATED CONTROLLERS shall be MONITORED in person by visual observation at the start of the operating day to ensure proper functioning.

5.7.3.7.4 **Activities** MONITORING shall include activities recommended by manufacturers, including but not limited to alerts and leaks.

5.7.3.7.5 **Replacement Parts** Only manufacturer-approved OEM replacement parts shall be used.

5.7.3.7.6 **Calibration** AUTOMATED CONTROLLERS shall be calibrated per manufacturer directions.

5.7.3.7.7^A **Ozone System** When an ozone system is utilized as a SECONDARY TREATMENT, the system shall be MONITORED and data recorded at a frequency consistent with MAHC Table 5.7.3.7.7.

Table 5.7.3.7.7: Ozone System Monitoring Frequency

Parameter	Monitoring Frequency	Recording Frequency
ORP	Continuous	Every 4 hours
Control System Indicating Ozone Being Created	Continuous	Every 4 Hours
Operational Indicators in Range	Continuous	Every 4 hours
Ozone Within 6 inches of Aquatic Venue Water Surface	Annual	Annual

5.7.3.7.7.1 **Other Testing** At the time the ozone generating equipment is installed, again after 24 hours of operation, and annually thereafter, the air space within 6 inches of the AQUATIC VENUE water shall be tested to determine compliance of less than 0.1 ppm (*mg/L*) gaseous ozone.

5.7.3.7.7.1.1 **Results** Results of the test shall be maintained onsite for review by the AHJ.

5.7.3.7.8^A **UV Systems** When a UV system is utilized as a SECONDARY TREATMENT, the system shall be MONITORED and data recorded at a frequency consistent with MAHC Table 5.7.3.7.8.

Table 5.7.3.7.8: UV System Monitoring and Calibration Frequency

Parameter	Monitoring Frequency	Recording Frequency
Flow Rate Monitoring	Continuous	Every 4 Hours
Intensity Monitoring	Continuous	Every 4 Hours
Water Temperature Monitoring (<i>Medium Pressure</i>)	Continuous	Daily
Set Point for Intensity Monitoring	Continuous	Daily
UV Lamp On/Off Cycle Monitoring	Continuous	Weekly (<i>Total Cycles/Week</i>)
Iron, Calcium Hardness Monitoring	Weekly (<i>If Fouling is Prevalent</i>)	Weekly
Calibration of UVT Analyzer (<i>if used</i>)	Per Manufacturer's Requirements	At Time of Calibration
Calibration of Intensity	Per Manufacturer's Requirements	At Time of Calibration
Calibration of Flow Meter	Per Manufacturer's Requirements	At Time of Calibration

5.7.3.7.9 *UV Alarm Testing and Maintenance* The automated UV shut-down alarm required in MAHC 4.7.3.3.6 shall be tested weekly and maintained as needed.

5.7.4 Water Sample Collection and Testing

5.7.4.1 **Sample Collection** The QUALIFIED OPERATOR shall ensure a water sample is acquired for testing from the in-line sample port when available as per MAHC 5.7.5.

5.7.4.1.1 *Same Volume* If an AQUATIC VENUE has more than one RECIRCULATION SYSTEM, the same sample volume shall be collected from each in-line sample port and tested separately.

5.7.4.1.2 *No Port* If no in-line sample port is available, the QUALIFIED OPERATOR shall ensure water samples from the AQUATIC VENUE are acquired according to MAHC 5.7.4.3.

5.7.4.2 **Routine Samples** If routine samples are collected from in-line sample ports, the QUALIFIED OPERATOR shall also ensure water samples are acquired from the bulk water of the AQUATIC VENUE at least once per day.

5.7.4.2.1 *Midday Collection* Daily bulk water samples shall be collected in the middle of the AQUATIC VENUE operational day, according to the procedures in MAHC 5.7.4.3.

5.7.4.2.2 *Compared* Water quality data from these AQUATIC VENUE samples shall be compared to data obtained from in-line port samples to assess potential water quality variability in the AQUATIC VENUE.

5.7.4.3^A **Bulk Water Sample** The QUALIFIED OPERATOR shall ensure the following procedure is used for acquiring a water sample from bulk water of the POOL.

5.7.4.3.1 *Obtain Sample* All samples shall be obtained from a location with the following qualities:

- 1) At least 18 inches (45.7 cm) below the surface of the water,
- 2) A water depth of 3–4 feet (91.4 cm to 1.2 m) when available, and
- 3) A location between water INLETS.

5.7.4.3.2 *Rotate* Sampling locations shall rotate around the shallow end of the POOL.

5.7.4.3.3 *Deepest Area* The QUALIFIED OPERATOR shall ensure a sample includes a deep end sample from the AQUATIC VENUE in the water sampling rotation once per week.

5.7.4.4^A **Aquatic Venue Water Chemical Balance**

5.7.4.4.1^A *Total Alkalinity* Total alkalinity shall be maintained in the range of 60 to 180 ppm (mg/L).

5.7.4.4.2^A *Combined Chlorine (Chloramines)* The owner shall ensure the AQUATIC FACILITY takes action to reduce the level of COMBINED CHLORINE (chloramines) in the water when the level exceeds 0.4 ppm (mg/L). Such actions may include but are not limited to:

- 1) Superchlorination,
- 2) Water exchange, or
- 3) PATRON adherence to appropriate BATHER hygiene practices.

5.7.4.4.3^A *Calcium Hardness* Calcium hardness shall not exceed 2500 ppm (mg/L).

5.7.4.4.4^A *Algaecides* Algaecides may be used in an AQUATIC VENUE provided:

- 1) The product is labeled as an algaecide for AQUATIC VENUE or SPA use;
- 2) The product is used in strict compliance with label instructions; and

3) The product is registered with the EPA and applicable state agency.

5.7.4.5^A Source (Fill) Water The owner of a public AQUATIC VENUE, public SPA, or SPECIAL USE AQUATIC VENUE shall ensure that the water supply for the facility meets one of the following requirements:

- 1) The water comes from a PUBLIC WATER SYSTEM as defined by the applicable rules of the AHJ in which the facility is located;
- 2) The water meets the requirements of the AHJ for PUBLIC WATER SYSTEMS; or
- 3) The AHJ has approved an alternative water source for use in the AQUATIC FACILITY.

5.7.4.6^A Water Balance for Aquatic Venues AQUATIC VENUE water shall be chemically balanced.

5.7.4.7^A Water Temperature

5.7.4.7.1 Minimize Risk and Protect Safety Water temperatures shall be considered and planned for based on risk, SAFETY, priority facility usage, and age of participants, while managing water quality concerns.

5.7.4.7.2^A Maximum Temperature The maximum temperature for an AQUATIC VENUE is 104° F (40°C).

5.7.5^A Water Quality Chemical Testing Frequency

5.7.5.1^A Chemical Parameters DPD-FC, COMBINED AVAILABLE CHLORINE (CAC), or TOTAL BROMINE (TB), and pH shall be tested at all AQUATIC VENUES prior to opening each day.

5.7.5.2 Manual Disinfectant Feed System For all AQUATIC VENUES using a manual disinfectant feed system that delivers disinfectant via a flow through erosion feeder or metering pump without an AUTOMATED CONTROLLER, DPD-FC or bromine and pH shall be tested prior to opening to the public and every 2 hours while open to the public.

5.7.5.3 Automatic Disinfectant Feed System For all AQUATIC VENUES using an automated disinfectant feed system, DPD-FC (or TB) and pH shall be tested prior to opening and every 4 hours while open to the public.

5.7.5.4 In-Line ORP Readings In-line ORP readings, if such systems are installed, shall be recorded at the same time the DPD-FC (or TB) and pH tests are performed.

5.7.5.5 Total Alkalinity Total Alkalinity (TA) shall be tested weekly at all AQUATIC VENUES.

5.7.5.6 Calcium Hardness Calcium hardness shall be tested monthly at all AQUATIC VENUES.

5.7.5.7 Cyanuric Acid CYA shall be tested monthly at all AQUATIC VENUES utilizing CYA.

5.7.5.7.1 Tested CYA shall be tested 24 hours after the addition of CYA to the AQUATIC VENUE.

5.7.5.7.2 Stabilized Chlorine If AQUATIC VENUES utilize stabilized CHLORINE as its primary disinfectant, the operator shall measure CYA concentrations weekly or more frequently as necessary to ensure compliance with MAHC 5.7.3.

5.7.5.8 Saturation Index The SATURATION INDEX shall be checked monthly.

5.7.5.9 Total Dissolved Solids TDS shall be tested quarterly at all AQUATIC VENUES.

5.7.5.10 Water Temperature For heated AQUATIC VENUES, water temperature shall be recorded at the same time the DPD-FC (or TB) and pH tests are performed.

5.7.5.11 Salt If in-line electrolytic chlorinators are used, salt levels shall be tested at least weekly or per manufacturer's instructions.

5.7.5.12 Copper/Silver Systems Copper and silver shall be tested daily at all AQUATIC VENUES

utilizing copper/silver systems as a SUPPLEMENTAL TREATMENT system.

5.7.6^A Water Clarity

5.7.6.1 Water Clarity The water in an AQUATIC VENUE shall be sufficiently clear such that the bottom is visible while the water is static at all times the AQUATIC VENUE is open or available for use.

5.7.6.1.1 Reference Tile The reference tile required in MAHC 4.5.1.2.1 through 4.5.1.2.4 shall be used to observe water clarity.

5.7.6.1.2 No Reference Tile In the absence of a reference tile or suction outlet, an alternate means of achieving the goal of observing the bottom of the pool may be permitted.

5.7.6.2 Visible This reference point shall be visible at all times at any point on the DECK up to 30 feet (9.1 m) away in a direct line of sight from the tile or main drain.

5.7.6.2.1 Spas For SPAS, this test shall be performed when the water is in a non-turbulent state and bubbles have been allowed to dissipate.

5.8 Decks and Equipment

5.8.1^A Deck Areas

5.8.1.1 Cross-Connection Control

5.8.1.1.1 Deck Drains BACKFLOW prevention devices shall be in good working order, and shall be tested as required by the AHJ.

5.8.1.2 Materials / Slip Resistant

5.8.1.2.1 Clean and Good Repair Surfaces shall be clean and in good repair.

5.8.1.2.2 Risk Management The finish and profile of DECK surfaces shall be maintained to prevent slips and falls.

5.8.1.2.3^A Tripping Hazards Tripping hazards shall be avoided.

5.8.1.2.3.1 Protect If tripping hazards are present, they shall be repaired or promptly barricaded to protect PATRONS/employees.

5.8.1.3 Deck Size/Width The PERIMETER DECK shall be maintained clear of obstructions for at least a 4 foot (1.2 m) width around the entire POOL unless otherwise allowed by this CODE.

5.8.2 Diving Boards and Platforms [N/A]

5.8.3^A Starting Platforms

5.8.3.1 Competitive Training and Competition Starting platforms shall only be used for competitive swimming and training.

5.8.3.1.1 Supervision Starting platforms shall only be used under the direct supervision of a coach or instructor.

5.8.3.1.2 Removed or Restricted Starting platforms shall be removed, if possible, or prohibited from use during all recreational or non-competitive swimming activity by covering platforms with a manufacturer-supplied platform cover or with another means or device that is readily visible and clearly prohibits use.

5.8.4 Pool Slides [N/A]

5.8.5 Lifeguard- and Safety-Related Equipment

5.8.5.1^A Equipment Inspection and Maintenance AQUATIC FACILITIES shall not be open to users

unless the equipment listed under MAHC 5.8.5 is present and in a safe and working condition.

5.8.5.2 Safety Equipment Required at All Aquatic Facilities

5.8.5.2.1 Emergency Communication Equipment

5.8.5.2.1.1^A Functioning Communication Equipment The AQUATIC FACILITY shall have equipment for staff to communicate in cases of emergency.

5.8.5.2.1.2^A Hard-Wired Telephone for 911 Call The AQUATIC FACILITY or each AQUATIC VENUE, as necessary, shall have a functional telephone or other communication system or device that is hard wired and capable of directly dialing 911 or function as the emergency notification system.

5.8.5.2.1.3 Conspicuous and Easily Accessible The telephone or communication system or device shall be conspicuously provided and accessible to AQUATIC VENUE users such that it can be reached immediately.

5.8.5.2.1.4^A Alternate Communication Systems Alternate functional systems, devices, or communication processes are allowed with AHJ approval in situations when a hardwired telephone is not logistically sound, and an alternate means of communication is available.

5.8.5.2.2 First Aid Equipment

5.8.5.2.2.1^A Location for First Aid The AQUATIC FACILITY shall have designated locations for emergency and first aid equipment.

5.8.5.2.2.2^A First Aid Supplies An adequate supply of first aid supplies shall be continuously stocked and include, at a minimum, as follows:

- 1) A first aid guide,
- 2) Absorbent compress,
- 3) Adhesive bandages,
- 4) Adhesive tape,
- 5) Sterile pads,
- 6) Disposable gloves,
- 7) Scissors,
- 8) Elastic wrap,
- 9) Emergency blanket,
- 10) Resuscitation mask with one-way valve, and
- 11) Blood-borne pathogen spill kit.

5.8.5.2.3 Signage

5.8.5.2.3.1^A Sign Indicating First Aid Location Signage shall be provided at the AQUATIC FACILITY or each AQUATIC VENUE, as necessary, which clearly identifies the following:

- 1) First aid location(s) and
- 2) Emergency telephone(s) or approved communication system or device.

5.8.5.2.3.2^A Emergency Dialing Instructions A permanent sign providing emergency dialing directions and the AQUATIC FACILITY address shall be posted and maintained at the emergency telephone, system, or device.

5.8.5.2.3.3^A Management Contact Info A permanent sign shall be conspicuously posted and maintained displaying contact information for emergency personnel and AQUATIC FACILITY management.

5.8.5.2.3.4^A **Hours of Operation** A sign shall be posted stating the following:

- 1) The operating hours of the AQUATIC FACILITY and
- 2) Unauthorized use of the AQUATIC FACILITY outside of these hours is prohibited.

5.8.5.3 Safety Equipment Required at Facilities with Lifeguards

5.8.5.3.1^A **UV Protection for Chairs and Stands** Lifeguards and lifeguard positions must be provided protection from UV radiation exposure.

5.8.5.3.2^A **Backboard** At least one backboard constructed of material easily SANITIZED/disinfected shall be provided.

5.8.5.3.2.1 **Backboard Number and Location** The number and location of backboards shall be sufficient to affect a 2-minute response time to the location of the incident.

5.8.5.3.2.2 **Backboard Components** The backboard shall be equipped with a head immobilizer and sufficient straps to immobilize a person to the backboard.

5.8.5.3.3^A **Rescue Tube Immediately Available** Each QUALIFIED LIFEGUARD conducting PATRON surveillance with the responsibility of in-water rescue in less than 3 feet (0.9 m) of water shall have a rescue tube immediately available for use.

5.8.5.3.4^A **Rescue Tube on Person** Each QUALIFIED LIFEGUARD conducting PATRON surveillance in a water depth of 3 feet (0.9 m) or greater shall have a rescue tube on his/her person in a rescue ready position.

5.8.5.3.5^A **Identifying Uniform** QUALIFIED LIFEGUARDS shall wear attire that readily identifies them as members of the AQUATIC FACILITY's lifeguard staff.

5.8.5.3.6^A **Signal Device** A whistle or other signaling device shall be worn by each QUALIFIED LIFEGUARD conducting PATRON surveillance for communicating to users and/or staff.

5.8.5.3.7^A **Sun Blocking Methods** All AQUATIC FACILITIES where QUALIFIED LIFEGUARDS can be exposed to UV radiation shall train lifeguards about the use of protective clothing, hats, sun-blocking umbrellas, and sunscreen application and re-application using or exceeding SPF Level 15 to protect exposed skin areas.

5.8.5.3.7.1 **Lifeguards Responsible** QUALIFIED LIFEGUARDS are responsible for protecting themselves from UV radiation exposure and wearing appropriate sunglasses and sunscreen.

5.8.5.3.8^A **Polarized Sunglasses** When glare impacts the ability to see below the water's surface, QUALIFIED LIFEGUARDS shall wear polarized sunglasses while conducting BATHER surveillance.

5.8.5.3.9^A **Personal Protective Equipment** Personal protective devices including a resuscitation mask with one-way valve and non-latex, non-powdered, one-use disposable gloves shall be worn in the form of a hip pack or attached to the rescue tube of all QUALIFIED LIFEGUARDS on-duty.

5.8.5.3.10^A **Rescue Throwing Device** AQUATIC FACILITIES with one QUALIFIED LIFEGUARD shall provide and maintain a U.S. Coast Guard-approved aquatic rescue throwing device as per the specifications of MAHC 5.8.5.4.1.

5.8.5.3.11^A **Reaching Pole** AQUATIC FACILITIES with one QUALIFIED LIFEGUARD shall provide and maintain a reaching pole as per the specifications of MAHC 5.8.5.4.2.

5.8.5.4 Safety Equipment and Signage Required at Facilities without Lifeguards

5.8.5.4.1^A **Throwing Device** AQUATIC VENUES whose depth exceeds 2 feet (61.0 cm) of standing water shall provide and maintain a U.S. Coast Guard-approved aquatic rescue throwing device, with at least a quarter-inch (6.3 mm) thick rope whose length is 50 feet (15.2 m) or 1.5 times the width of the POOL, whichever is less.

5.8.5.4.1.1 Throwing Device Location The rescue throwing device shall be located in the immediate vicinity to the AQUATIC VENUE and be accessible to BATHERS.

5.8.5.4.2^A Reaching Pole AQUATIC VENUES whose depth exceeds 2 feet (61 cm) of standing water shall provide and maintain a reaching pole of 12 feet (3.7 m)–16 feet (4.9 m) in length, non-telescopic, light in weight, and with a securely attached Shepherd's Crook with an aperture of at least 18 inches (45.7 cm).

5.8.5.4.2.1 Reaching Pole Location The reaching pole shall be located in the immediate vicinity to the AQUATIC VENUE and be accessible to BATHERS and PATRONS.

5.8.5.4.2.2 Non-Conductive Material Reaching poles provided by the AQUATIC FACILITY after the adoption date of this CODE shall be of non-conductive material.

5.8.5.4.3^A CPR Posters CPR posters that are up to date with latest CPR programs and protocols shall be posted conspicuously at all times.

5.8.5.4.4^A Imminent Health Hazard Sign A sign shall be posted outlining the IMMINENT HEALTH HAZARDS, which require AQUATIC VENUE or AQUATIC FACILITY closure as defined in this CODE per MAHC 6.6.3.1 and a telephone number to report problems to the owner/operator.

5.8.5.4.5^A Additional Signage For any AQUATIC VENUE with standing water, a sign shall be posted signifying a QUALIFIED LIFEGUARD is not on duty and that the following rules apply:

- 1) Persons under the age of 14 years cannot be in the AQUATIC VENUE without direct supervision by a person aged 18 years or older; and
- 2) Youth and childcare groups, training, lifeguard courses, and swim lessons are not allowed without a QUALIFIED LIFEGUARD providing PATRON surveillance.

5.8.6 Barriers and Enclosures

5.8.6.1 General Requirements All required ENCLOSURES shall be maintained to prevent unauthorized entry to the protected space.

5.8.6.2 Construction Requirements (N/A)

5.8.6.3 Gates and Doors

5.8.6.3.1 Self-Closing and Latching All primary public access gates or doors serving as part of an ENCLOSURE shall have functional self-closing and self-latching closures unless the gate or door meets the exceptions in MAHC 4.8.6.3.1.6.1 or 4.8.6.3.1.6.2 and staff and QUALIFIED LIFEGUARDS are provided per MAHC 6.3.4.1 and 6.3.4.3.1.

5.8.6.3.1.1 Exception Gates or doors used solely for after-hours maintenance shall remain locked at all times when not in use by staff.

5.8.6.3.1.2 Propping Open Required self-closing and self-latching gates or doors serving as part of a guarded ENCLOSURE may be maintained in the open position when the AQUATIC VENUE is open and staffed as required.

5.9^A Filter/Equipment Room

5.9.1 Chemical Storage

5.9.1.1^A Code Compliance Chemical storage shall be in compliance with all applicable local, state, territorial, federal, and tribal laws.

5.9.1.2^A OSHA and EPA Chemical handling shall be in compliance with OSHA and EPA regulations.

5.9.1.3^A Safety Data Sheets For each chemical, STORAGE, handling, and use of the chemical shall be

in compliance with the manufacturer's SDS and labels.

5.9.1.4 Access Prevention AQUATIC VENUE chemicals shall be stored to prevent access by unauthorized individuals.

5.9.1.5^A Protected AQUATIC VENUE chemicals shall be stored so that they are protected from getting wet.

5.9.1.6^A No Mixing AQUATIC VENUE chemicals shall be stored so that if the packages were to leak, no mixing of incompatible materials would occur.

5.9.1.6.1 Safety Data Sheets Consulted SDS shall be consulted for incompatibilities.

5.9.1.7^A Ignition Sources Possible ignition sources, including but not limited to gasoline, diesel, natural gas, or gas-powered equipment such as lawn mowers, motors, grills, POOL heaters, or portable stoves shall not be stored or installed in the CHEMICAL STORAGE SPACE.

5.9.1.8 Smoking Smoking shall be prohibited in the CHEMICAL STORAGE SPACE.

5.9.1.9^A Lighting Lighting shall be at minimum 30 footcandles (*323 lux*) to allow operators to read labels on containers throughout the CHEMICAL STORAGE SPACE and pump room.

5.9.1.10^A Personal Protective Equipment PPE shall be available as indicated on the chemical SDSs.

5.9.1.11 Storage Chemicals shall be stored away from direct sunlight, temperature extremes, and high humidity.

5.9.1.12 Single Container A single container of a particular chemical that has been opened and that is currently in use in the pump room may be kept in a staging area of the pump room only if the chemical(s) will be protected from exposure to heat and moisture.

5.9.1.13 Separate The CHEMICAL STORAGE SPACE shall be separate from the equipment room.

5.9.1.13.1 Waiver For AQUATIC FACILITIES that do not currently have a CHEMICAL STORAGE SPACE separate from the EQUIPMENT ROOM, this requirement may be waived at the discretion of the local public health and/or fire officials if the chemicals are protected from exposure to heat and moisture and no IMMINENT HEALTH HAZARDS or SAFETY threats are identified.

5.9.1.14 Warning Signs Warning signs in compliance with NFPA or HMIS ratings shall be posted on CHEMICAL STORAGE SPACE doors.

5.9.2 Chemical Handling

5.9.2.1 Identity Containers of chemicals shall be labeled, tagged, or marked with the identity of the material and a statement of the hazardous effects of the chemical according to OSHA or EPA materials labeling requirements.

5.9.2.1.1 Labeling All AQUATIC VENUE chemical containers shall be labeled according to OSHA or EPA materials labeling requirements.

5.9.2.2 NSF Standard The chemical equipment used in controlling the quality of water shall be CERTIFIED, LISTED, AND LABELED to NSF/ANSI 50 by an ANSI-accredited certification organization and used only in accordance with the manufacturer's instructions.

5.9.2.3 Measuring Devices Chemicals shall be measured using a dedicated measuring device where applicable.

5.9.2.3.1 Clean and Dry These measuring devices shall be clean, dry, and constructed of material compatible with the chemical to be measured to prevent the introduction of incompatible chemicals.

5.9.2.4 Chemical Addition Methods

5.9.2.4.1 *Automatically Introduced* DISINFECTION and pH control chemicals shall be automatically introduced through the RECIRCULATION SYSTEM.

5.9.2.4.1.1 *Manual Addition* SUPERCHLORINATION or shock chemicals and other POOL chemicals other than DISINFECTION and pH control may be added manually to the POOL.

5.9.2.4.1.2 *Absence of Bathers* Chemicals added manually directly into the AQUATIC VENUE shall only be introduced in the absence of BATHERS.

5.9.2.4.2 *Safety Requirements* Treatment chemicals shall be added in strict adherence to the manufacturer's use instructions to ensure levels in the water are safe for human exposure. Refer to MAHC 5.7.3.

5.9.2.4.2.1 *Diluted* Whenever required by the manufacturer, chemicals shall be diluted (*or mixed with water*) prior to application and as per the manufacturer's directions.

5.9.2.4.2.2 *Added* Chemicals shall be added to water when diluting as opposed to adding water to a concentrated chemical.

5.9.2.4.2.3 *Mixed* Each chemical shall be mixed in a separate, labeled container.

5.9.2.4.2.3.1 *Never Mixed Together* Two or more chemicals shall never be mixed in the same dilution water.

5.10 Hygiene Facilities

5.10.1 General [N/A]

5.10.2 Location [N/A]

5.10.3 Bathhouse Design [N/A]

5.10.4 Plumbing Fixture Requirements

5.10.4.1^A General Requirements

5.10.4.1.1 *Cleaned and Sanitized* HYGIENE FACILITY FIXTURES, dressing area FIXTURES, and furniture shall be cleaned and SANITIZED daily with an EPA-REGISTERED product, and more often if necessary, to provide a clean and sanitary environment.

5.10.4.1.2 *Mold and Mildew* HYGIENE FACILITY floors, walls, and ceilings shall be kept clean and free of visible mold and mildew.

5.10.4.1.3 *Hand Wash Station* HANDWASHING STATIONS shall include the following items:

- 1) Hand wash sink,
- 2) Adjacent soap with dispenser,
- 3) Hand drying device or paper towels and dispenser, and
- 4) Trash receptacle.

5.10.4.2 Cleansing Showers

5.10.4.2.1 *Cleaned and Sanitized* CLEANSING SHOWERS shall be cleaned and SANITIZED daily with an EPA-REGISTERED product, and more often if necessary, to provide a clean and sanitary environment.

5.10.4.3^A Rinse Showers

5.10.4.3.1 *Cleaned* RINSE SHOWERS shall be cleaned daily and more often if necessary with an EPA-REGISTERED product and more often if necessary to provide a clean and sanitary environment.

5.10.4.3.2 *Easy Access* RINSE SHOWERS shall be easily accessible.

5.10.4.3.3 *Not Blocked* Equipment and furniture on the DECK shall not block access to RINSE SHOWERS.

5.10.4.3.4 *No Soap* Soap dispensers and soap shall be prohibited at RINSE SHOWERS.

5.10.4.4 All Showers [N/A]

5.10.4.5^A Diaper-Changing Stations DIAPER-CHANGING STATIONS are required in all AQUATIC FACILITIES upon adoption of this CODE per MAHC 4.10.4.5.1.

5.10.4.5.1 *Hand Wash Sink Installed and Operational* The adjacent handwashing sink shall be installed and operational within *1* year from the date of the AHJ's adoption of the MAHC.

5.10.4.5.2 *Cleaned* DIAPER-CHANGING STATIONS shall be cleaned and disinfected daily and more often if necessary to provide a clean and sanitary environment.

5.10.4.5.2.1 *Maintained* They shall be maintained in good condition and free of visible contamination.

5.10.4.5.3 *Disinfectant* EPA-REGISTERED disinfectant shall be provided in the form of either of the following:

- 1) A solution in a spray dispenser with paper towels and dispenser, or
- 2) Wipes contained within a dispenser.

5.10.4.5.3.1 *Covers* If disposable DIAPER-CHANGING UNIT covers are provided in addition to disinfectant, they shall cover the DIAPER-CHANGING UNIT surface during use and keep the unit in clean condition.

5.10.4.5.4 *Portable Handwashing Station* If a portable HANDWASHING STATION is provided for use it shall be operational and maintained in good condition at all times.

5.10.4.6^A Non-Plumbing Fixture Requirements

5.10.4.6.1 *Paper Towels* If paper towels are used for hand drying, a dispenser and paper towels shall be provided for use at HANDWASHING STATIONS.

5.10.4.6.2 *Soap* Soap dispensers shall be provided at HANDWASHING STATIONS and CLEANSING SHOWERS and shall be kept full of liquid or granular soap.

5.10.4.6.2.1 *Bar Soap* Bar soap shall be prohibited.

5.10.4.6.3 *Trash* A minimum of one hands-free trash receptacle shall be provided in areas adjacent to handwashing sinks.

5.10.4.6.3.1 *Trash Emptying* Trash receptacles shall be emptied daily and more often if necessary to provide a clean and sanitary environment.

5.10.4.6.4 *Floor Coverings* Non-permanent floor coverings (*including but not limited to mats and racks*) shall be removable and maintained in accordance with MAHC 5.10.4.1.1.

5.10.4.6.4.1 *Wood* Wooden racks, duckboards, and wooden mats shall be prohibited on HYGIENE FACILITY and dressing area flooring.

5.10.4.7 Sharps

5.10.4.7.1 *Biohazard Action Plan* A biohazard action plan shall also be on file as required by all applicable local, state, territorial, federal, and tribal laws and as part of the AQUATIC FACILITY SAFETY PLAN.

5.10.4.7.2 *Disposed* Sharps within approved containers shall be disposed of as needed by the

AQUATIC FACILITY in accordance with all applicable local, state, territorial, federal, and tribal laws.

5.10.5 Provision of Suits, Towels, and Shared Equipment

5.10.5.1^A Towels All towels provided by the AQUATIC FACILITY shall be washed with detergent in warm water, rinsed, and thoroughly dried at the warmest temperature listed on the fabric label after each use.

5.10.5.2 Suits Any attire provided by the AQUATIC FACILITY shall be washed in accordance with the fabric label or manufacturer's instructions.

5.10.5.3 Receptacles Non-absorbent, easily cleanable receptacles shall be provided for collection of used suits and towels.

5.10.5.4^A Shared Equipment Cleaned and Sanitized Equipment provided by the AQUATIC FACILITY that comes into contact with BATHER's eyes, nose, ears, and mouth (*including but not limited to snorkels, nose clips, and goggles*) shall be cleaned, SANITIZED between uses, and stored in a manner to prevent biological growth.

5.10.5.5^A Other Equipment Other shared equipment provided by the AQUATIC FACILITY, including but not limited to fins, kickboards, tubes, lifejackets, and noodles, shall be kept clean and stored in a manner to prevent mold and other biological growth.

5.10.5.6 Good Repair Shared equipment shall be maintained in good repair.

5.10.5.7 Used Equipment Used and un-SANITIZED shared equipment shall be kept separate from cleaned and SANITIZED shared equipment.

5.10.5.7.1 Receptacles Non-absorbent, easily cleanable receptacles shall be provided for collection of used shared equipment.

5.11 Water Supply / Wastewater Disposal [N/A]

5.12 Special Requirements for Specific Aquatic Venues

5.12.1 Spas

5.12.1.1 Required Operation Time SPA filtration systems shall be operated 24 hours per day except for periods of draining, filling, and maintenance.

5.12.1.2^A Drainage and Replacement SPAS shall be drained, cleaned, scrubbed, and water replaced as calculated in MAHC 5.12.1.2.1 or as needed to maintain water clarity and quality per MAHC.

5.12.1.2.1 Calculated The water replacement interval (*in days*) shall be calculated by dividing the SPA volume (*in gallons*) by 3 and then dividing by the average number of users per day or at a minimum of every 1–2 weeks.

5.12.1.3 Scrubbed SPA surfaces, including interior of SKIMMERS, shall be scrubbed or wiped down, and all water drained prior to refill.

5.12.2^A Waterslides and Landing Pools

5.12.2.1 Signage Warning signs shall be posted in accordance with manufacturer's recommendations.

5.12.3 Wave Pools

5.12.3.1^A Life Jackets U.S. Coast Guard-approved life jackets that are properly sized and fitted shall be

provided free and shall be available at, or adjacent to, the AQUATIC VENUE.

5.12.4 Therapy Pools [N/A]

5.12.5 Lazy Rivers [N/A]

5.12.6 Moveable Floors

5.12.6.1 Starting Platforms The use of starting platforms in the area of a MOVEABLE FLOOR shall be prohibited when the water depth is shallower than the minimum required water depth of 4 feet (1.2 m). Use may only occur as per MAHC 5.6.10.3.

5.12.6.2 Diving Boards When a MOVEABLE FLOOR is installed into a DIVING POOL, diving shall be prohibited unless the DIVING POOL depth meets criteria set in MAHC 4.8.2.1.1.

5.12.7 Bulkheads

5.12.7.1 Open Area If a BULKHEAD is operated with an open area underneath, no one shall be allowed to swim beneath the BULKHEAD.

5.12.7.2 Bulkhead Travel The BULKHEAD position shall be maintained such that it cannot encroach on any required clearances of other features such as diving boards.

5.12.8 Interactive Water Play Aquatic Venues

5.12.8.1 Cracks CRACKS in the INTERACTIVE WATER PLAY AQUATIC VENUE shall be repaired when they may be a potential for leakage, present a tripping hazard, a potential cause of lacerations, or impact the ability to properly clean and maintain the INTERACTIVE WATER PLAY AQUATIC VENUE area.

5.12.8.2 Cleaning When cleaning the INTERACTIVE WATER PLAY AQUATIC VENUE CONTAMINANTS shall be removed or washed to the sanitary sewer.

5.12.8.2.1 No Sanitary Sewer Drain Available If no sanitary sewer drain is available then debris shall be washed/rinsed to the nearest DECK drain or removed in a manner that prevents CONTAMINANTS from reentering the INTERACTIVE WATER PLAY AQUATIC VENUE.

5.12.9 Wading Pools [N/A]

5.12.10 Other Aquatic Venues [N/A]

6.0 Policies and Management

The provisions of Chapter 6 shall apply to all AQUATIC FACILITIES covered by this CODE regardless of when constructed, unless otherwise noted.

Note: Section numbers with superscript “A” (e.g., 6.0^A) denote a corresponding discussion in the Annex to the Model Aquatic Health Code.

6.0.1^A Staff Training All QUALIFIED OPERATORS, RESPONSIBLE SUPERVISORS, maintenance staff, QUALIFIED LIFEGUARD staff, or any others who are involved in the STORAGE, use, or handling of chemicals shall receive training prior to access of chemicals and receive at least an annual review of procedures thereafter for the following topics discussed in MAHC 6.0.1.1 to 6.0.1.5.

6.0.1.1 Storage and Handling Procedures for chemical storage and handling outlined in this CODE.

6.0.1.2 Personal Protective Equipment Procedures STANDARD precautions, PPE, and other measures to minimize exposure to chemicals as required by OSHA. This shall include staff training in PPE and respiratory protective devices when required.

6.0.1.3 Spill Procedures Spill Procedures and Emergency Response outlined in this CODE.

6.0.1.4 OSHA Requirements Federal OSHA Requirements: Hazard Communication Standard (*Employee Right-to-Know*) and SDS. Know the location and availability of STANDARD and the written program.

6.0.1.5 Chemical and Safety Data Sheets Lists Know workplace chemicals list and SDS.

6.0.1.6 Training Plan Employers shall have a training plan in place and implement training for employees on chemicals used at the AQUATIC FACILITY before their first assignment and whenever a new hazard is introduced into the work area.

6.0.1.6.1^A Training Topics The training shall include at a minimum:

- 1) How to recognize and avoid chemical hazards,
- 2) The physical and health hazards of chemicals used at the facility,
- 3) How to detect the presence or release of a hazardous chemical,
- 4) Required PPE necessary to avoid the hazards,
- 5) Use of PPE,
- 6) Chemical spill response, and
- 7) How to read and understand the chemical labels or other forms of warning including SDS sheets.

6.0.1.7 Training Records Records of all training shall be recorded and maintained on file.

6.0.1.8^A Body Fluid Exposure Employees assigned to roles which have the potential for an occupational exposure to bloodborne pathogens, pathogens that cause RWIs, or other pathogens shall be trained to recognize and respond to body fluid (*blood, feces, vomit*) releases in and around the AQUATIC VENUE area.

6.0.1.9 Exposure Control Program Employers shall have an Exposure Control Program for bloodborne pathogens as required by OSHA 29 CFR 1910.1030.

6.0.1.10 Personal Protective Equipment Provided and Disposed PPE shall be provided and

properly disposed.

6.1 Qualified Operator Training

6.1.1^A Qualified Operator Qualifications and Certification

6.1.1.1 Qualifications A QUALIFIED OPERATOR of an AQUATIC FACILITY shall have completed an operator training course that is recognized by the AHJ.

6.1.1.2 Training Documentation A QUALIFIED OPERATOR shall have a current certificate or written documentation acceptable to the AHJ showing completion of an operator training course.

6.1.1.2.1 Certificate Available Originals or copies of such certificate or documentation shall be available onsite for inspection by the AHJ for each QUALIFIED OPERATOR employed at or contracted by the site, as specified in this CODE.

6.1.1.2.2 Originals Originals shall be made available upon request by the AHJ.

6.1.2^A Essential Topics in Qualified Operator Training Courses

6.1.2.1 Course Content All operator training courses recognized by the AHJ shall include, at a minimum, the following teaching elements:

- 1) Water disinfection,
- 2) Water chemistry,
- 3) Mechanical systems, and
- 4) Health and SAFETY operations.

6.1.2.1.1^A Water Disinfection Water DISINFECTION including:

- 1) Water disinfection,
- 2) CT or Concentration X Time values,
- 3) Chlorine,
- 4) CYA,
- 5) Bromine,
- 6) Breakpoint,
- 7) Superchlorination,
- 8) Hyperchlorination,
- 9) Combined chlorine,
- 10) Secondary treatment, and
- 11) Supplemental treatment.

6.1.2.1.1.1 Disinfectants Disinfectant types including:

- 1) Descriptions of different types of disinfectants,
- 2) Their unique physical (*e.g., shape or state [solid, liquid, or gas]*) and chemical properties (*e.g., how it reacts with acids or bases*),
- 3) How they disinfect and impact water chemistry and MONITORING systems,
- 4) How to calculate dosing,

- 5) How they are used safely, and
- 6) The advantages or disadvantages of using each disinfectant.

6.1.2.1.1.2 CT Inactivation Values CT or Concentration x Time values including:

- 1) How to calculate the amount of time needed to inactivate PATHOGENS at a given concentration of a disinfectant, and
- 2) The importance and reasons for maintaining appropriate water pH and temperature.

6.1.2.1.1.3 Bromine Bromine including:

- 1) Definition of bromine as an element,
- 2) Its use as a residual disinfectant and oxidizer in water,
- 3) Bromine chemistry,
- 4) The DISINFECTION role of HOBr,
- 5) Onsite generation,
- 6) pH meter requirements to prevent false readings, and
- 7) Bromine reuse.

6.1.2.1.1.4 Chlorine CHLORINE including:

- 1) Definition of CHLORINE as an element,
- 2) Its use as a residual disinfectant and oxidizer in water,
- 3) CHLORINE chemistry and the role of pH,
- 4) The DISINFECTION role of HOCl,
- 5) Unstabilized products (*sodium hypochlorite, calcium hypochlorite, lithium hypochlorite, and CHLORINE gas*),
- 6) Stabilized products (*sodium dichloro-s-triazinetriene and trichloro-s-triazinetriene*),
- 7) Safe chemical handling, and
- 8) Onsite CHLORINE generation.

6.1.2.1.1.5 Cyanuric Acid CYA and stabilized CHLORINE product use including:

- 1) Description of CYA and how CHLORINE is bound to it,
- 2) Description of CYA use via addition of stabilized CHLORINE compounds or addition of CYA alone,
- 3) Response curves showing the impact of CYA on stabilization of FREE CHLORINE RESIDUALS in the presence of UV,
- 4) Dose response curves showing the impact of CYA on CHLORINE kill rates including the impact of CYA concentrations on diarrheal fecal incident remediation procedures,
- 5) Strategies for controlling the concentration of CYA,
- 6) Strategies for reducing the concentration of CYA when it exceeds the maximum allowable level, and
- 7) Response curves showing the impact of CYA on HOCl concentrations.

6.1.2.1.1.6 Breakpoint Chlorination Breakpoint chlorination including how to achieve it through calculation of chemical dosing to reach the desired free DPD-FC concentration and its relationship to reducing and controlling formation of combined chlorine including guidance for how to perform breakpoint chlorination in indoor aquatic facilities.

6.1.2.1.1.7 **Hyperchlorination** HYPERCHLORINATION includes procedures for implementing a CONTAMINATION RESPONSE PLAN for fecal/vomit/blood.

6.1.2.1.1.8 **Combined Chlorine** Combined chlorine including:

- 1) How different COMBINED CHLORINE and DBPs are formed in the water and air;
- 2) The maximum acceptable level of COMBINED CHLORINE;
- 3) How methods such as water replacement, BREAKPOINT CHLORINATION, UV light, ozone, ventilation, and use of other oxidizers can reduce COMBINED CHLORINE level;
- 4) The advantages and disadvantages of each; and
- 5) Possible health effects of COMBINED CHLORINE products in the air, particularly in INDOOR AQUATIC FACILITIES.

6.1.2.1.1.9 **Secondary Disinfection** SECONDARY TREATMENT including:

- 1) How ozone and UV disinfectants are used in conjunction with residual disinfectants to inactivate pathogens and
- 2) Sizing guidelines/dosing calculations, safe use, and advantages and disadvantages of each method.

6.1.2.1.1.10 **Supplemental Treatment** SUPPLEMENTAL TREATMENT includes other DISINFECTION chemicals or systems on the market and their effectiveness in water treatment.

6.1.2.1.2 **Water Chemistry** Course work for water chemistry shall include:

- 1) Source water,
- 2) Water balance,
- 3) Saturation index,
- 4) Water clarity,
- 5) pH,
- 6) Total alkalinity,
- 7) Calcium hardness,
- 8) Water temperature,
- 9) Total dissolved solids,
- 10) Water treatment systems, and
- 11) Water testing.

6.1.2.1.2.1 **Source Water** Source water including requirements for supply and pre-treatment.

6.1.2.1.2.2 **Water Balance** Water balance including:

- 1) Effect of unbalanced water on DISINFECTION, AQUATIC FEATURE surfaces, mechanical equipment, and FIXTURES; and
- 2) Details of water balance including pH, total alkalinity, calcium hardness, temperature, and TDS.

6.1.2.1.2.3 **Saturation Index** SATURATION INDEX including calculations, ideal values, and effects of values which are too low or too high.

6.1.2.1.2.4 **Water Clarity** Water clarity including:

- 1) Reasons why water quality is so important,
- 2) Causes of poor water clarity,

- 3) Maintenance of good water clarity, and
- 4) Closure requirements when water clarity is poor.

6.1.2.1.2.5 **pH** pH including:

- 1) How pH is a measure of the concentration of hydrogen ions in water,
- 2) Effects of high and low pH on BATHERS and equipment,
- 3) Ideal pH range for BATHER and equipment,
- 4) Factors that affect pH,
- 5) How pH affects disinfectant efficacy, and
- 6) How to decrease and increase pH.

6.1.2.1.2.6 **Total Alkalinity** Total alkalinity including:

- 1) How total alkalinity relates to pH,
- 2) Effects of low and high total alkalinity,
- 3) Factors that affect total alkalinity,
- 4) Ideal total alkalinity range, and
- 5) How to increase or decrease total alkalinity.

6.1.2.1.2.7 **Calcium Hardness** Calcium hardness including:

- 1) Why water naturally contains calcium,
- 2) How calcium hardness relates to total hardness and temperature,
- 3) Effects of low and high calcium hardness,
- 4) Factors that affect calcium hardness,
- 5) Ideal calcium hardness range, and
- 6) How to increase or decrease calcium hardness.

6.1.2.1.2.8 **Temperature** Water temperature including:

- 1) How low and high water temperatures increase the likelihood of corrosion and scaling, respectively;
- 2) Effect on DISINFECTION, its health effects, and other operational considerations;
- 3) Health effects; and
- 4) Other operational considerations.

6.1.2.1.2.9 **Total Dissolved Solids** TDS including:

- 1) Why the concentration of TDS increases over time,
- 2) Association with conductivity and organic CONTAMINANTS, and
- 3) Key TDS levels as they relate to starting up an AQUATIC FACILITY and galvanic corrosion.

6.1.2.1.2.10 **Water Treatment Systems** Water treatment systems including:

- 1) Descriptions of system use, MONITORING, calibration, and maintenance of automatic controllers;
- 2) Descriptions of common types of liquid, dry chemical, and gas mechanical feeders;
- 3) CHLORINE, bromine, and ozone generators;

- 4) UV light systems;
- 5) Unique features of feeders, generators, and systems;
- 6) How to generally operate and maintain them;
- 7) Advantages and disadvantages of different feeders, UV light systems, and ozonator types; and
- 8) Alternate treatment methods.

6.1.2.1.2.11 Water Testing Water testing including:

- 1) How different methods (*including but not limited to colorimetric, titrimetric, turbidimetric, and electronic*) test water to determine the following levels:
 - a. DPD-FC and TOTAL AVAILABLE CHLORINE,
 - b. TOTAL BROMINE,
 - c. pH,
 - d. Total alkalinity,
 - e. Calcium hardness,
 - f. Temperature,
 - g. TDS,
 - h. CYA,
 - i. Metals, and
 - j. Any other tests (*including but not limited to salt concentrations, phosphates, nitrates, potassium monopersulfate, copper, iron, and bacterial testing*);
- 2) The advantages and disadvantages of each method;
- 3) How to maintain testing equipment;
- 4) How to collect water samples;
- 5) How to perform and interpret tests;
- 6) How frequently to test;
- 7) The steps of the dilution method; and
- 8) How to calculate COMBINED CHLORINE levels.

6.1.2.1.3 Mechanical Systems Course work for mechanical systems shall include:

- 1) Calculations,
- 2) Circulation,
- 3) Main drains,
- 4) Gutters and surface SKIMMERS,
- 5) Mechanical system balance,
- 6) Circulation pump and motor,
- 7) Valve,
- 8) Return INLETS,
- 9) Filtration, and

10) Filter backwashing/cleaning.

6.1.2.1.3.1 Maintenance Calculations Calculations including:

- 1) Explanations of why particular calculations are important;
- 2) How to convert units of measurement within and between the English and metric systems;
- 3) How to determine the surface area of regularly and irregularly shape AQUATIC VENUES;
- 4) How to determine the water volume of regularly and irregularly shaped AQUATIC VENUES; and
- 5) Why proper sizing of filters, pumps, pipes, and feeders is important.

6.1.2.1.3.2 Circulation Circulation including:

- 1) Why circulation is needed;
- 2) Factors that affect water flow;
- 3) How direct suction and overflow systems work;
- 4) How to calculate TURNOVER and flow rates;
- 5) How the following components of the circulation system relate to each other:
 - a. Main drains,
 - b. Gutters and surface SKIMMERS,
 - c. Circulation pump and motor,
 - d. Surge tanks,
 - e. Vacuum ports,
 - f. Valves, and
 - g. Return INLETS;
- 6) How to read flow meters;
- 7) How to safely operate pressurized systems after the pump;
- 8) Information on dye testing;
- 9) An understanding of TDH;
- 10) How it TDH calculated;
- 11) How TDH is field-determined using vacuum and pressure gauges;
- 12) TDH effect on pump flow; and
- 13) Cross-connections.

6.1.2.1.3.3 Main Drains Main drains including:

- 1) A description of the role of main drains,
- 2) Why they should not be resized without engineering and public health consultation,
- 3) The importance of daily inspection of structural integrity, and
- 4) Discussion on balancing the need to maximize surface water flow while minimizing the likelihood of entrapment.

6.1.2.1.3.4 Gutters & Surface Skimmers Gutters and surface SKIMMERS including:

- 1) Why it is important to collect surface water,
- 2) A description of different gutter types (*at a minimum: scum, surge, and rim-flow*),
- 3) How each type generally works,
- 4) The advantages and disadvantages of each, and
- 5) Description of the components of SKIMMERS (*e.g., weir, basket, and equalizer assembly*) and their respective roles.

6.1.2.1.3.5 Mechanical System Balance Mechanical system balance including:

- 1) An understanding of mechanical system balancing,
- 2) Methodology for setting proper operational water levels,
- 3) Basic hydraulics which affect proper functioning of the balance tank and AQUATIC VENUE,
- 4) Methods of setting and adjusting modulation valves,
- 5) Balance lines,
- 6) Skimmers,
- 7) Main drains,
- 8) The operation of the water make-up system,
- 9) Collector tanks/gravity drainage systems, and
- 10) Automatic controllers.

6.1.2.1.3.6 Circulation Pump & Motor Circulation pump and motor including:

- 1) Descriptions of the role of the pump and motor,
- 2) Self-priming and flooded suction pumps,
- 3) Key components of a pump and how they work together,
- 4) Cavitation,
- 5) Possible causes of cavitation, and
- 6) Troubleshooting problems with the pump and motor.

6.1.2.1.3.7 Valves Valves including descriptions of different types of valves (*e.g., gate, ball, butterfly/wafer, multi-port, globe, modulating / automatic, and check*) and their safe operation.

6.1.2.1.3.8 Return Inlets Return INLETS including a description of the role of return INLETS and the importance of replacing fittings with those that meet original specifications.

6.1.2.1.3.9 Filtration Filtration including:

- 1) Why filtration is needed;
- 2) A description of pressure and vacuum filters and different types of filter media;
- 3) How to calculate filter surface area;
- 4) How to read pressure gauges;
- 5) A general description of sand, cartridge, and diatomaceous earth filters and alternative filter media types to include, at a minimum, perlite, zeolite, and crushed glass;
- 6) The characteristic flow rates and particle size entrapment of each filter type;
- 7) How to generally operate and maintain each filter type;

- 8) Troubleshooting problems with the filter; and
- 9) The advantages and disadvantages of different filters and filter media.

6.1.2.1.3.10 Filter Backwashing/Cleaning Filter backwashing/cleaning including:

- 1) Determining and setting proper backwash flow rates,
- 2) When backwashing/cleaning should be done and the steps needed for clearing a filter of fine particles and other CONTAMINANTS,
- 3) Proper disposal of wastewater from backwash, and
- 4) What additional FIXTURES/equipment may be needed (*i.e., sump, separation tank*).

6.1.2.1.4^A Health and Safety Course work for health and SAFETY shall include:

- 1) Recreational water illness,
- 2) RWI prevention,
- 3) Risk management,
- 4) Record keeping,
- 5) Chemical SAFETY,
- 6) Entrapment prevention,
- 7) Electrical SAFETY,
- 8) Rescue equipment,
- 9) Injury prevention,
- 10) Drowning prevention,
- 11) BARRIERS and ENCLOSURES,
- 12) Signage and depth markers,
- 13) Facility sanitation,
- 14) Emergency response, and
- 15) Surveillance and supervision.

6.1.2.1.4.1^A Recreational Water Illness Recreational water illness (*RWI*) including:

- 1) How water can contain or become contaminated with parasites, bacteria, viruses, fungi, DBPs, or unsafe levels of chemicals and
- 2) The role of the operator in reducing risk.

6.1.2.1.4.2 Causes of RWIs Common infectious and chemical causes of RWIs, including but not limited to:

- 1) Diarrheal illness (*Cryptosporidium, Giardia, Shigella, and norovirus*),
- 2) Skin rashes (*Pseudomonas aeruginosa, molluscum contagiosum virus*),
- 3) Respiratory illness (*Legionella*),
- 4) Neurologic infections (*echovirus, Naegleria*),
- 5) Eye/ear illness (*Pseudomonas aeruginosa, adenovirus, Acanthamoeba*),
- 6) Hypersensitivity reactions (*Mycobacterium avium complex, Pontiac fever, endotoxins*), and

7) Health effects of chloramines and DBPs.

6.1.2.1.4.3^A **RWI Prevention** Recreational water illness (*RWI*) prevention including:

- 1) Methods of prevention of RWIs, including but not limited to chemical level control;
- 2) Why public health, operators, and PATRONS need to be educated about RWIs and collaborate on RWI prevention;
- 3) The role of showering;
- 4) The efficacy of swim diapers;
- 5) Formed-stool and diarrheal fecal incident response; and
- 6) Developing a plan to minimize pathogen and other biological (*e.g., blood, vomit, sweat, urine, and skin and hair care products*) contamination of the water.

6.1.2.1.4.4 **Risk Management** Risk management including techniques that identify hazards and risks and that prevent illness and injuries associated with AQUATIC FACILITIES open to the public.

6.1.2.1.4.5 **Record Keeping** Record keeping including the need to keep accurate and timely records of the following areas:

- 1) Operational conditions (*e.g., water chemistry, water temperature, filter pressure differential, flow meter reading, and water clarity*),
- 2) Maintenance performed (*e.g., backwashing, change of equipment*),
- 3) Incidents and response (*e.g., fecal incidents in the water and injuries*), and
- 4) Staff training and attendance.

6.1.2.1.4.6^A **Chemical Safety** Chemical SAFETY including steps to safely store and handle chemicals including:

- 1) How to read labels and SDS,
- 2) How to prevent individual chemicals and inorganic and organic CHLORINE products from mixing together or with other substances (*including water*) or in chemical feeders, and
- 3) Use of PPE.

6.1.2.1.4.7^A **Entrapment Prevention** Entrapment prevention including:

- 1) Different types of entrapment (*e.g., hair, limb, body, evisceration/disembowelment, and mechanical*),
- 2) How to prevent and/or decrease likelihood of entrapment, and
- 3) Requirements of the VGB Act.

6.1.2.1.4.8 **Electrical Safety** Electrical SAFETY including possible causes of electrical shock and steps that can be taken to prevent electrical shock (*e.g., bonding, grounding, GROUND-FAULT CIRCUIT INTERRUPTERS, and prevention of accidental immersion of electrical devices*).

6.1.2.1.4.9 **Rescue Equipment** Rescue equipment including a description and rationale for the most commonly found rescue equipment including:

- 1) Rescue tubes,
- 2) Reaching poles,
- 3) Ring buoys and throwing lines,
- 4) Backboards,
- 5) First aid kits,

- 6) Emergency alert systems,
- 7) Emergency phones with current numbers posted, and
- 8) Resuscitation equipment.

6.1.2.1.4.10 Injury Prevention Injury prevention including basic steps known to decrease the likelihood of injury, at a minimum:

- 1) Banning glass containers at AQUATIC FACILITIES,
- 2) PATRON education, and
- 3) Daily visual inspection for hazards.

6.1.2.1.4.11 Drowning Prevention Drowning prevention including causes and prevention of drowning.

6.1.2.1.4.12 Enclosures ENCLOSURES including descriptions of how fences, gates, doors, and safety covers can be used to prevent access to water; and basics of design that effectively prevent access to water.

6.1.2.1.4.13 Signage & Depth Markers Signage and depth markers including the importance of maintaining signage and depth markers.

6.1.2.1.4.14 Facility Sanitation Facility sanitation including:

- 1) Steps to clean and disinfect all surfaces that PATRONS would commonly come in contact with (*e.g., DECK, restrooms, and DIAPER-CHANGING STATIONS*) and
- 2) Procedures for implementation of MAHC 6.5: *Fecal-Vomit-Blood Contamination Response*, in relation to responding to a body fluid spill on these surfaces.

6.1.2.1.4.15 Emergency Response Plan Emergency response plan including:

- 1) Steps to respond to emergencies (*at a minimum, severe weather events, drowning or injury, contamination of the water, chemical incidents*) and
- 2) Communication and coordination with emergency responders and local health department notification as part of an EAP.

6.1.2.1.5^A Operations Course work for operations shall include:

- 1) Regulations;
- 2) The role of local, state, territorial, and tribal health departments;
- 3) Aquatic facility types;
- 4) Daily/routine operations;
- 5) Preventive maintenance;
- 6) Weatherizing;
- 7) AQUATIC FACILITY renovation and design;
- 8) Heating;
- 9) Air circulation; and
- 10) Spa and therapy pool issues.

6.1.2.1.5.1 Regulations Regulations including applicable local, state, territorial, federal, and tribal laws and STANDARDS relating to the operation of AQUATIC FACILITIES.

6.1.2.1.5.1.1 Immediate Closure Course work shall also highlight reasons why an

inspector or operator would immediately close an AQUATIC FACILITY.

6.1.2.1.5.2 Health Departments Duties and responsibilities of local, state, territorial, and tribal health departments including stressing the importance of a good working relationship with the health department.

6.1.2.1.5.3 Aquatic Facility Types AQUATIC FACILITY types including common AQUATIC VENUE types and settings and a discussion of features and play equipment that require specific operation and maintenance steps.

6.1.2.1.5.4^A Daily/Routine Operations Daily/routine operations including listing and describing the daily inspection and maintenance requirements of an AQUATIC FACILITY including, but not limited to items listed:

- 1) Walkways/DECK and exits are clear, clean, free of debris;
- 2) Drain covers, vacuum fitting covers, SKIMMER equalizer covers, and any other suction outlet covers are in place, secure, and unbroken;
- 3) SKIMMER baskets, weirs, lids, flow adjusters, and suction outlets are free of any blockage;
- 4) INLET and return covers and any other fittings are in place, secure, and unbroken;
- 5) Safety warning signs and other signage are in place and in good repair;
- 6) Entrapment prevention systems are operational;
- 7) Recirculation, DISINFECTION systems, controller(s), and probes are operating as required;
- 8) SECONDARY TREATMENT or SUPPLEMENTAL TREATMENT systems are operating as required;
- 9) Underwater lights and other lighting are intact with no exposed wires or water in lights;
- 10) Slime and biofilm have been removed from accessible surfaces of AQUATIC VENUE, SLIDES, and other AQUATIC FEATURES;
- 11) Doors to nonpublic areas (*CHEMICAL STORAGE SPACES, offices, etc.*) are locked;
- 12) First aid supplies are stocked;
- 13) Emergency communication equipment and systems are operational;
- 14) Fecal/vomit/blood incident CONTAMINATION RESPONSE PLANS, materials, and equipment are available;
- 15) AQUATIC FEATURES and amenities are functioning in accordance with the manufacturer's recommendations;
- 16) Fencing/ENCLOSURES, gates, and self-latching or other locks are tested and are intact and functioning properly, and ENCLOSURES do not have nearby furniture to encourage climbing;
- 17) Drinking fountains are clean and in functional condition;
- 18) Electrical devices are in good working condition and meet the requirements specified in the MAHC;
- 19) Alarms, if required, are tested and functioning properly;
- 20) Assessing glare conditions throughout operating hours to assess whether the bottom and objects in the POOL are clearly visible;
- 21) Play structures and diving boards are in good condition;
- 22) Safety equipment as required by this CODE is in good condition, properly secured, accessible for intended use, and shall include at a minimum:
 - a. Emergency instructions and phone numbers,

- b. Rescue tubes,
 - c. Resuscitation masks with one-way valve,
 - d. First aid kits,
 - e. AEDs,
 - f. Emergency oxygen,
 - g. Backboard, head immobilizer, straps, and
 - h. Lifeguard stands;
- 23) Emergency shut-off systems (*SLIDES, water features, pumps, etc.*) function properly;
- 24) Depth markings are clearly visible;
- 25) Lifelines and buoys are in place and in good working order;
- 26) Ladders are SLIP RESISTANT and rungs secured tightly;
- 27) WATERSLIDES are in functional, safe condition;
- 28) Moveable fulcrum is adjusted properly to control spring in the board as necessary;
- 29) Moveable starting platforms are properly stored;
- 30) Access to permanent starting platforms is restricted or controlled when not in use by swim teams and prohibited when not in use by competitive swimming or swimming practice that is under direct supervision of an instructor or coach;
- 31) Railings are secure;
- 32) SVRS is functioning according to manufacturer's guidelines;
- 33) SKIMMER baskets and covers are clean and in place;
- 34) Water quality and clarity is MAHC compliant;
- 35) Water level is appropriate;
- 36) Pumps retain the appropriate pressure;
- 37) Play structures are secure (*consider water velocity and reference manufacturers recommended levels*);
- 38) Verify required documentation and records are in place and signed by the appropriate personnel; and
- 39) Soap dispensers in lavatories and SHOWERS are functional and supplied with soap.

6.1.2.1.5.5 Preventive Maintenance Preventive maintenance including how to develop:

- 1) A preventive maintenance plan,
- 2) Routine maintenance procedures, and
- 3) Record keeping system needed to track maintenance performed.

6.1.2.1.5.6 Weatherizing Weatherizing including the importance of weatherizing and the steps to prevent damage to AQUATIC FACILITIES and their mechanical systems due to very low temperatures or extreme weather conditions (*e.g., flooding*).

6.1.2.1.5.7 Facility Renovation & Design AQUATIC FACILITY renovation and design including:

- 1) Definitions of AQUATIC FACILITY renovation, remodeling, and SUBSTANTIAL ALTERATION;
- 2) When it is necessary to renovate;
- 3) When it is necessary to notify the AHJ of planned renovations and remodeling; and

- 4) Current trends in facility renovation and design.

6.1.2.1.5.8 Heating Heating issues including:

- 1) Recommended water temperatures and limits,
- 2) Factors that contribute to the water's heat loss and gain,
- 3) Heating equipment options,
- 4) Sizing gas heaters, and
- 5) How to troubleshoot problems with heaters.

6.1.2.1.5.9 Air Circulation Air circulation including:

- 1) Air handling system considerations for an indoor aquatic facility,
- 2) The importance of regulating humidity,
- 3) The need to maintain negative pressure,
- 4) How poor indoor air quality can affect PATRONS and staff, and
- 5) How to balance air change and energy efficiency.

6.1.2.1.5.10 Spa & Therapy Pool Issues SPA and THERAPY POOL issues including:

- 1) Operational implications of smaller volumes of water and HOT WATER;
- 2) How to maintain water chemistry;
- 3) Typical water temperature ranges highlighting maximum temperatures;
- 4) Risks of hyperthermia and hypothermia;
- 5) Need for emergency shut-off switches; and
- 6) Frequency of cleaning, draining, and DISINFECTION.

6.1.3 General Requirements for Operator Training Courses

6.1.3.1 Course Providers

6.1.3.1.1 Recognized Courses Providers of recognized operator training courses, if required by the AHJ to verify that the course meets the requirements and intent of this CODE, shall submit course information including:

- 1) Course development expertise,
- 2) Course content,
- 3) Course length,
- 4) Instructor qualifications,
- 5) Exam administration,
- 6) Certificate procedures, and
- 7) Updates of information as changes are made.

6.1.3.1.2 Providers Operator training courses shall be developed by individuals or organizations with expertise in AQUATIC FACILITY operation and maintenance and expertise in education or training as evidenced by combined work experience and training.

6.1.3.2 Course Content Training materials at a minimum, covering all of the essential topics as

outlined in MAHC 6.1.2.1 shall be provided and used in operator training courses.

6.1.3.3^A Course Length Course agenda or syllabus shall show time planned for each essential topic.

6.1.3.4^A Instructor Requirements Operator training course providers shall furnish course instructor information including:

- 1) Expertise in AQUATIC FACILITY operation and maintenance, as evidenced by work experience and/or training;
- 2) Completion of an operator training course, which at a minimum, covers all of the essential topics as outlined in MAHC 6.1.2.1, including passing the final exam,
- 3) Successful completion of an operator training instructor course, and
- 4) If the operator training course is online, procedures which make such an instructor available to answer students' questions during normal business hours.

6.1.3.5^A Final Exam Operator training course providers shall furnish course final exam information including:

- 1) Final exam(s), which at a minimum, covers all of the essential topics as outlined in MAHC 6.1.2.1,
- 2) Final exam passing score criteria, and
- 3) Final exam security procedures.

6.1.3.5.1 Final Exam Administration Operator training course providers shall provide final exam administration, proctoring and security procedures including:

- 1) Checking student's government-issued photo identification, or another established process, to ensure that the individual taking the exam is the same person who is given a certificate documenting course completion and passing of exam;
- 2) Final exam completion is without assistance or aids that are not allowed by the training agency; and
- 3) Final exam is passed, prior to issuance of a QUALIFIED OPERATOR certificate.

6.1.3.6^A Course Certificates Operator training course providers shall furnish course certificate information including:

- 1) Procedures for issuing nontransferable certificates to the individuals who successfully complete the course work and pass the final exam,
- 2) Procedures for delivery of course certificates to the individuals who successfully complete the course work and pass the final exam,
- 3) Instructions for the participant to maintain their originally issued certificate, or a copy thereof, for the duration of its validity, and
- 4) Procedures for the operator training course provider to maintain an individual's training and exam record for a minimum period of 5 years after the expiration of the individual's certificate.

6.1.3.7^A Continuing Education [N/A]

6.1.3.8^A Certificate Renewal Operator training course providers shall furnish course certificate renewal information including:

- 1) Criteria for re-examination with a renewal exam that meets the specifications for initial exam requirements and certificate issuance specified in this CODE or
- 2) Criteria for a refresher course with an exam that meets the specifications for the initial course, exam, and certificate issuance requirements specified in this CODE.

6.1.3.9^A Certificate Suspension and Revocation Course providers shall have procedures in place for the suspension or revocation of certificates.

6.1.3.9.1 Evidence of Health Hazard Course providers may suspend or revoke a QUALIFIED OPERATOR'S certificate based on evidence that the QUALIFIED OPERATOR'S actions or inactions unduly created SAFETY and health hazards.

6.1.3.9.2 Evidence of Cheating Course providers may suspend or revoke a QUALIFIED OPERATOR'S certificate based on evidence of cheating or obtaining the certificate under false pretenses.

6.1.3.10^A Additional Training or Testing The AHJ may, at its discretion, require additional operator training or testing.

6.1.3.11^A Certificate Recognition The AHJ may, at its discretion, choose to recognize, not to recognize, or rescind a previously recognized certificate of a QUALIFIED OPERATOR based upon demonstration of inadequate knowledge, poor performance, or due cause.

6.1.3.12^A Course Recognition The AHJ may, at its discretion, recognize, choose not to recognize, or revoke a previously accepted course based upon demonstration of inadequate knowledge or poor performance of its QUALIFIED OPERATORS, or due cause.

6.1.3.13^A Length of Certificate Validity The maximum length of validity for QUALIFIED OPERATOR training certificate shall be 5 years.

6.2^A Lifeguard Training

6.2.1^A Lifeguard Qualifications A qualified lifeguard shall:

- 1) Have successfully completed an AHJ-recognized lifeguard training course offered by an AHJ-recognized training agency,
- 2) Possess a current certificate for such training,
- 3) Have met all pre-service requirements, and
- 4) Participate in continuing in-service training requirements of the AQUATIC FACILITY.

6.2.1.1^A Course Content Lifeguard Training Courses shall include but not be limited to:

- 1) Hazard identification and injury prevention,
- 2) Emergencies,
- 3) CPR,
- 4) AED use,
- 5) BVM (adult & pediatric) use,
- 6) First aid, and
- 7) Legal issues.

6.2.1.1.1^A Hazard Identification and Injury Prevention Hazard identification and injury prevention shall include:

- 1) Identification of common hazards or causes of injuries and their prevention,
- 2) Responsibilities of a QUALIFIED LIFEGUARD in prevention strategies,
- 3) Victim recognition,
- 4) Victim recognition scanning strategies,

- 5) Factors which impede victim recognition,
- 6) Health and SAFETY issues related to lifeguarding, and
- 7) Prevention of voluntary hyperventilation and extended breath holding activities.

6.2.1.1.2^A Emergency Response Skill Set Emergency response content shall include:

- 1) Responsibilities of a QUALIFIED LIFEGUARD in reacting to an emergency;
- 2) Recognition and identification of a person in distress and/or drowning;
- 3) Methods to communicate in response to an emergency;
- 4) Rescue skills for a person who is responsive or unresponsive, in distress, or drowning;
- 5) Skills required to rescue a person to a position of safety;
- 6) Skills required to extricate a person from the water with assistance from another lifeguard(s) and/or PATRON(S); and
- 7) Knowledge of the typical components of an EAP for AQUATIC VENUES.

6.2.1.1.3^A Resuscitation Skills CPR/AED, AED use, BVM (*adult & pediatric*) use, and other resuscitation skills shall be professional level skills that follow treatment protocols consistent with the current ECC and/or; the ILCOR guidelines for cardiac compressions; foreign body restriction removal; and rescue breathing for infants, children, and adults.

6.2.1.1.4 First Aid First aid training shall include:

- 1) Basic treatment of bleeding, shock, sudden illness, and muscular/skeletal injuries;
- 2) Knowing when and how to activate the EMS;
- 3) Rescue and emergency care skills to minimize movement of the head, neck and spine until EMS arrives for a person who has suffered a suspected spinal injury on land or in the water; and
- 4) Use and the importance of universal precautions and PPE in dealing with body fluids, blood, and preventing contamination according to current OSHA guidelines.

6.2.1.1.5^A Legal Issues Course content related to legal issues shall include but not be limited to:

- 1) Duty to act,
- 2) STANDARD of care,
- 3) Negligence,
- 4) Consent,
- 5) Refusal of care,
- 6) Abandonment,
- 7) Confidentiality, and
- 8) Documentation.

6.2.1.2 Lifeguard Training Delivery

6.2.1.2.1^A Standardized and Comprehensive The educational delivery system shall include standardized student and instructor materials to convey all topics including but not limited to those listed per MAHC 6.2.1.1.

6.2.1.2.2^A Skills Practice Physical training of lifeguarding skills shall include in-water and out-of-water skill practices led by an individual currently certified as an instructor by the training agency which

developed the lifeguard course materials.

6.2.1.2.3^A Shallow Water Training If a training agency offers a certification with a distinction between “shallow water” and “deep water” lifeguards, candidates for shallow water certification shall have training and evaluation in the deepest depth allowed for the certification.

6.2.1.2.4^A Deep Water Training If a training agency offers a certification with a distinction between “shallow water” and “deep water” lifeguards, candidates for deep water certification shall have training and evaluation in at least the minimum depth allowed for the certification.

6.2.1.2.5^A Sufficient Time Course length shall provide sufficient time to cover content, practice, skills, and evaluate competency for the topics listed in MAHC 6.2.1.1.

6.2.1.2.6^A Certified Instructors Lifeguard instructor courses shall be taught only by individuals currently certified as instructor trainers by the training agency which developed the lifeguard course materials.

6.2.1.2.6.1^A Minimum Prerequisites Lifeguard training agencies shall develop minimum instructor prerequisites that include, but are not limited to, those outlined in MAHC 6.2.1.2.6.2.

6.2.1.2.6.2^A Completed Training Prior to instructing lifeguard training, instructors are required to have successfully completed a lifeguard training course which complies with MAHC 6.2.1.1 and a lifeguard instructor training course which includes, at a minimum, the following:

- 1) Mastery and knowledge of lifeguard training course content,
- 2) Demonstration of the ability to effectively deliver lifeguard training course content,
- 3) An evaluation and feedback process to improve instructor candidate presentation skills/techniques,
- 4) Course management and administration procedures, and
- 5) Testing and evaluation procedures.

6.2.1.2.6.3^A Instructor Renewal/Recertification Process Lifeguard training agencies shall have a lifeguard instructor renewal/recertification process.

6.2.1.2.6.4^A Quality Control Training agencies shall have a quality control system in place for evaluating a lifeguard instructor’s ability to conduct courses.

6.2.1.2.7^A Training Equipment All lifeguard training courses shall have, at a minimum, the following pieces of equipment available in appropriate student to equipment ratios during the course:

- 1) Rescue tubes,
- 2) Backboard with head immobilizer and sufficient straps to immobilize the victim to the backboard,
- 3) CPR manikins (*Adult and infant*),
- 4) Resuscitation mask with one-way valve,
- 5) BVM (*Adult and Pediatric*),
- 6) Disposable gloves,
- 7) AED trainer with adult and pediatric training pads,
- 8) First aid supplies for first aid training, and
- 9) Manikin cleaning supplies.

6.2.1.3 Competency and Certification

6.2.1.3.1 Proficiency Lifeguarding skills per MAHC 6.2.1.1 shall be tested, by a certified instructor, to a level of proficiency accepted by the training agency.

6.2.1.3.2^A **Requirements** Lifeguard training course providers shall have a final exam including but not limited to:

- 1) Written and practical exams covering topics outlined in MAHC 6.2.1.1;
- 2) Final exam passing score criteria, including the level of proficiency needed to pass practical and written exams; and
- 3) Security procedures for proctoring the final exam to include:
 - a. Checking student's government-issued photo identification, or another established process, to ensure that the individual taking the exam is the same person who is given a certificate documenting course completion and passing of exam; and
 - b. Final exam is passed, prior to issuance of a certificate.

6.2.1.3.3^A **Instructor Physically Present** The instructor of record shall be physically present at all classroom and in-person contact time, skills evaluation, and testing during the course.

6.2.1.3.4^A **Certifications** Lifeguard and lifeguard instructor certifications shall be issued to recognize successful completion of the course as per the requirements of MAHC 6.2.1.1 through 6.2.1.3.8.

6.2.1.3.5^A **Number of Years** Length of valid certification shall be a maximum of 2 years for lifeguarding and first aid, and a maximum of 1 year for Cardiopulmonary Resuscitation (*CPR/AED*).

6.2.1.3.6^A **Documentation** Course documentation of training and certificates shall identify the following:

- 1) Name of trainee,
- 2) Level of training,
- 3) Expiration date,
- 4) Restrictions on depth of water for which the lifeguard is qualified,
- 5) Identifier of the instructor of record,
- 6) Any other restrictions that maybe applied by the training agency, and
- 7) Identifier of the agency providing the certification.

6.2.1.3.7^A **Expired Certificate** When a certificate has expired for more than 45 days, the QUALIFIED LIFEGUARD shall retake the course.

6.2.1.3.7.1 **Expired Less than 45 Days** When a certificate has expired for 45 days or less, the QUALIFIED LIFEGUARD shall retake the course or complete a challenge program.

6.2.1.3.7.2^A **Challenge Program** A QUALIFIED LIFEGUARD challenge program, when utilized, shall be completed in accordance with the training of the original certifying agency, by an instructor certified by the original certifying agency, and include but not be limited to:

- 1) Pre-requisite screening;
- 2) A final practical exam, with certified instructor present, demonstrating all skills, in and out of the water required in the original lifeguard course for certification, which complies with MAHC 6.2.1.1, and uses the equipment specified in MAHC 6.2.1.2.7; and
- 3) Final written, proctored exam.

6.2.1.3.7.3^A **Certificate Renewal** Certificate renewal, when used, shall include the following:

- 1) Completion no later than 45 days after certificate expiration;
- 2) Conducted in accordance with the training of the original certifying agency;

- 3) Taught by an instructor certified by the original certifying agency;
- 4) Conducted with a demonstration of skills, in and out of the water, required in the original course, which complies with MAHC 6.2.1.1, and uses the equipment specified in MAHC 6.2.1.2.7;
- 5) A final written, proctored exam; and
- 6) A final practical exam with a certified instructor(s) of record present and actively administering the practical testing; or
- 7) Completion of a Challenge Program in accordance with MAHC 6.2.1.3.7.2, no later than 45 days after certificate expiration.

6.2.1.3.8^A *Certificate Suspension and Revocation* Lifeguard training agencies shall have procedures in place for the suspension or revocation of certificates.

6.2.2 Lifeguard Supervisor Training

6.2.2.1^A **Lifeguard Supervisor Candidate Prerequisites** LIFEGUARD SUPERVISOR candidate prerequisites shall include but not be limited to:

- 1) Successful completion of a lifeguard training course in the past,
- 2) Previous experience as a QUALIFIED LIFEGUARD of at least 3 months, and
- 3) Ability to effectively communicate verbally in English.

6.2.2.2^A **Lifeguard Supervisor Training Elements** LIFEGUARD SUPERVISOR training shall include, at a minimum, the following:

- 1) Activation and execution of EAPs,
- 2) CPR/AED and first aid training that complies with MAHC 6.2.1.1.3 and 6.2.1.1.4 or present an unexpired certificate issued by an AHJ-approved agency documenting the required training has been completed,
- 3) Scanning and vigilance requirements and how to ensure that systems which accomplish these goals are in place and operational,
- 4) Development and evaluation of zones of BATHER surveillance responsibility diagrams for an AQUATIC VENUE,
- 5) MONITORING lifeguard performance as it relates to lifeguard and facility-specific training, including pre-service assessments,
- 6) Strategies to reduce risk and mitigate the health and SAFETY hazards to both the PATRONS and the staff,
- 7) Knowledge of the legal issues and responsibilities relating to lifeguarding as listed in MAHC 6.2.1.1.5, and
- 8) Knowledge of the proper use and maintenance of the equipment required per MAHC 5.8.5.

6.2.2.3 Lifeguard Supervisor Training Delivery

6.2.2.3.1^A *Standardized and Comprehensive*

6.2.2.3.1.1 **Traditional and Blended Courses** For traditional and blended learning courses, the educational delivery system shall include standardized student and instructor content and delivery to convey all topics including but not limited to those listed per MAHC 6.2.2.2.

6.2.2.3.1.2 **E-Learning Courses** For e-learning courses, the educational delivery system shall include defined learning objectives, and standardized student content and delivery to convey all topics including but not limited to those listed per MAHC 6.2.2.2.

6.2.2.3.2^A *Sufficient Time*

6.2.2.3.2.1 Traditional and Blended Courses For traditional and blended learning classes, course length shall provide sufficient time to cover content, demonstration, skill practice, and evaluate competency for the topics listed in MAHC 6.2.2.2.

6.2.2.3.2.2 E-Learning Courses For e-learning courses, course length shall provide sufficient time to cover content, provide for online activities relating to content as necessary to reinforce comprehension of learning objectives, and assessments sufficient to evaluate competency for the topics listed in MAHC 6.2.2.2.

6.2.2.3.3 Course Setting LIFEGUARD SUPERVISOR training courses shall be:

- 1) Taught in person by a trained LIFEGUARD SUPERVISOR instructor,
- 2) Blended learning offerings with electronic content deliverables created, and presented by, and in-person portions taught by, trained LIFEGUARD SUPERVISOR instructors, or
- 3) Online offerings created and presented by trained LIFEGUARD SUPERVISOR instructors.

6.2.2.3.4^A Lifeguard Supervisor Course Instructor Certification LIFEGUARD SUPERVISOR course instructors shall be certified through a training agency or by the facility whose training programs meets the requirements specified in MAHC 6.2.2.

6.2.2.3.4.1 Lifeguard Supervisor Course Instructor LIFEGUARD SUPERVISOR course shall be taught by trained LIFEGUARD SUPERVISOR instructors through a training agency or by the facility whose training programs meets the requirements specified in MAHC 6.2.2.

6.2.2.3.4.2^A Minimum Prerequisites Course providers shall develop minimum instructor prerequisites that include, but are not limited to:

- 1) Successful completion of a lifeguard training course in the past;
- 2) Successful completion of a LIFEGUARD SUPERVISOR training course that complies with MAHC 6.2.2.2;
- 3) Ability to effectively communicate in English;
- 4) Has completed a LIFEGUARD SUPERVISOR instructor training course which includes, at a minimum, the following:
 - a. Mastery and knowledge of LIFEGUARD SUPERVISOR training course content,
 - b. Demonstration of the ability to effectively deliver LIFEGUARD SUPERVISOR training course content,
 - c. An evaluation and feedback process to improve instructor candidate presentation skills/techniques,
 - d. Course management and administration procedures, and
 - e. Testing and evaluation procedures.

6.2.2.3.4.3^A Quality Control Course provider shall have a quality control system in place for evaluating a LIFEGUARD SUPERVISOR instructor's ability to conduct courses.

6.2.2.3.4.4 Lifeguard Supervisor Renewal & Recertification LIFEGUARD SUPERVISOR training agencies shall have a LIFEGUARD SUPERVISOR instructor renewal/recertification process.

6.2.2.4 Competency and Certificate of Completion

6.2.2.4.1^A Lifeguard Supervisor Proficiency LIFEGUARD SUPERVISOR training course providers shall have a method to evaluate proficiency of the content in MAHC 6.2.2.2.

6.2.2.4.2^A Lifeguard Supervisor Certificate of Completion LIFEGUARD SUPERVISOR certificates of completion shall be issued by the course provider to recognize successful completion of the course as per the requirements of MAHC 6.2.2.2.

6.2.2.4.3 *Number of Years* Length of valid certification shall be a maximum of 2 years.

6.3 Facility Staffing

6.3.1 Qualified Operator Requirements and Availability

6.3.1.1 Onsite Qualified Operator Requirements

6.3.1.1.1 *At Adoption* The following MAHC sections shall be required for all AQUATIC FACILITIES at time of adoption:

- 1) MAHC 6.3.1.1: Onsite QUALIFIED OPERATORS and
- 2) MAHC 6.3.1.2: Contracted Off-Site QUALIFIED OPERATORS.

6.3.1.1.2 *Size and Use* A QUALIFIED OPERATOR shall be onsite or immediately available within 2 hours during all hours of operation at an AQUATIC FACILITY that has:

- 1) More than two AQUATIC VENUES,
- 2) An AQUATIC VENUE of over 50,000 gallons of water,
- 3) AQUATIC VENUES that include AQUATIC FEATURES with recirculated water,
- 4) An aquatic venue used as a therapy pool, or
- 5) An AQUATIC VENUE used to provide swimming training.

6.3.1.1.3 *Bathers and Management* A QUALIFIED OPERATOR shall be onsite or immediately available within 2 hours during all hours of operation at an AQUATIC FACILITY that is:

- 1) Permitted BATHER COUNT is greater than 200 BATHERS daily,
- 2) Operated by a municipality, or
- 3) Operated by a school.

6.3.1.1.4 *Compliance History* A QUALIFIED OPERATOR shall be available onsite or immediately available within 2 hours during all hours of operation at an AQUATIC FACILITY that has a history of CODE violations which in the opinion of the permit issuing official require one or more onsite QUALIFIED OPERATORS.

6.3.1.2 *Contracted Off-site Qualified Operators* All other AQUATIC FACILITIES shall have an onsite QUALIFIED OPERATOR immediately available within 2 hours or a contract with a QUALIFIED OPERATOR for a minimum of weekly visits and assistance whenever needed.

6.3.1.2.1 *Visit Documentation* Written documentation of these visits for contracted off-site QUALIFIED OPERATOR visits and assistance consultations shall be available at the AQUATIC FACILITY for review by the AHJ.

6.3.1.2.2 *Documentation Details* The written documentation shall indicate the checking, MONITORING, and testing outlined in MAHC 6.4.1.2.

6.3.1.2.3 *Visit Corrective Actions* The written documentation shall indicate what corrective actions, if any, were taken by the contracted off-site QUALIFIED OPERATOR during the scheduled visits or assistance requests.

6.3.1.2.4 *Onsite Responsible Supervisor* All AQUATIC FACILITIES without a full time onsite QUALIFIED OPERATOR shall have a designated onsite RESPONSIBLE SUPERVISOR.

6.3.1.2.5^A *Onsite Responsible Supervisor Duties* The designated onsite RESPONSIBLE SUPERVISOR shall:

- 1) Be capable of testing and recording the water quality parameters required by this CODE,
- 2) Know how to make adjustments, as needed, to maintain required water quality parameters required by this CODE,
- 3) Know general maintenance procedures as required by daily operational verifications or adjustments required by this CODE,
- 4) Know when the AQUATIC FACILITY or individual AQUATIC VENUE should be closed, and
- 5) Know how and when to contact the contracted off-site QUALIFIED OPERATOR.

6.3.2 Aquatic Facilities Requiring Qualified Lifeguards AQUATIC VENUES with standing water and with any of the following conditions listed in MAHC 6.3.2.1 shall be required to have a lifeguard(s) sufficient to meet the requirements of MAHC section 6.3.3.1 conducting PATRON surveillance at all times the AQUATIC VENUE is open.

6.3.2.1^A List of Aquatic Facilities Requiring Qualified Lifeguards *Note: This list includes but shall not be limited to the following:*

- 1) For new construction occurring from the date of acceptance of this CODE, any AQUATIC VENUE deeper than 5 feet (1.5 m) at any point;
- 2) Any AQUATIC VENUE that allows for unsupervised children under the age of 14 years;
- 3) Any AQUATIC VENUE while it is being used for the recreation of youth groups, including but not limited to childcare usage or school groups;
- 4) Any AQUATIC VENUE while it is being used for group training must have dedicated lifeguards on DECK for class surveillance, sufficient to meet the requirements of MAHC 6.3.3.1, including but not limited to competitive swimming and/or sports, lifeguard training, exercise programs, and swimming lessons;
- 5) Any AQUATIC VENUE with a configuration in which any point on the AQUATIC VENUE surface exceeds 30 feet (9.1 m) from the nearest DECK;
- 6) Any AQUATIC VENUE with an induced current or wave action including but not limited to WAVE POOLS and LAZY RIVERS;
- 7) Waterslide landing pools;
- 8) Any AQUATIC VENUE in which BATHERS enter the water from any height above the DECK including but not limited to diving boards, DROP SLIDES, starting platforms, and/or climbing walls. This includes POOL SLIDES that discharge into water depths deeper than 5 feet (1.5 m); and
- 9) Any AQUATIC FACILITY that sells or serves alcohol within the AQUATIC VENUE ENCLOSURE, during the periods when alcohol is sold or served.

6.3.3^A Safety Plan All AQUATIC FACILITIES shall create and implement a SAFETY PLAN to include, but not be limited to the following elements:

- 1) Staffing plan,
- 2) EAP,
- 3) Biohazard action plan,
- 4) Pre-service training plan, and
- 5) In-service training plan.

6.3.3.1^A Code Compliance Staff Plan Staffing plans shall designate person(s) as members of the SAFETY TEAM and person(s) for the following responsibilities:

- 1) Identifying and communicating health and SAFETY hazards;

- 2) Mitigating health and SAFETY hazards and closing the facility, if needed;
- 3) Interfacing with the AHJ related to the requirements of this CODE;
- 4) Maintaining water quality and, if required, air quality;
- 5) Enforcing the AQUATIC FACILITY rules and regulations;
- 6) Responding to reported emergencies;
- 7) Supervising the SAFETY TEAM;
- 8) Conducting pre-service evaluations; and
- 9) Conducting in-service training.

6.3.3.1.1^A *Zone of Patron Surveillance* When QUALIFIED LIFEGUARDS are used, the staffing plan shall include diagrammed zones of PATRON surveillance for each AQUATIC VENUE such that:

- 1) The QUALIFIED LIFEGUARD is capable of viewing the entire area of the assigned zone of PATRON surveillance;
- 2) The QUALIFIED LIFEGUARD is able to reach the furthest extent of the assigned zone of PATRON surveillance within 20 seconds;
- 3) Identify whether the QUALIFIED LIFEGUARD is in an elevated stand, walking, in-water and/or other approved position;
- 4) Identifying any additional responsibilities for each zone; and
- 5) All areas of each AQUATIC VENUE are assigned a zone of PATRON surveillance.

6.3.3.1.2^A *Rotation Procedures* When QUALIFIED LIFEGUARDS are used, the staffing plan shall include QUALIFIED LIFEGUARD rotation procedures such that:

- 1) Identifying all zones of PATRON surveillance responsibility at the AQUATIC FACILITY,
- 2) Operating in a manner so as to provide an alternation of tasks such that no QUALIFIED LIFEGUARD conducts PATRON surveillance activities for more than 60 continuous minutes, and
- 3) Have a practice of maintaining coverage of the zone of PATRON surveillance during the change of the QUALIFIED LIFEGUARD.

6.3.3.1.3 *Alternation of Tasks* Alternation of tasks may include any one of the following:

- 1) Change of zone of PATRON surveillance where the QUALIFIED LIFEGUARD must walk or be transported to another zone of PATRON surveillance.
- 2) Have a period of at least 10 minutes of non-PATRON surveillance activity such as taking a break, conducting maintenance, or conducting ride dispatch.

6.3.3.1.4 *Supervision Protocols* When QUALIFIED LIFEGUARDS are used, the staffing plan shall include lifeguard supervision protocols to achieve the requirements of MAHC 6.3.3.

6.3.3.2^A *Emergency Action Plan* EAPs and operating procedures shall include but not be limited to:

- 1) Outline types of emergencies and IMMINENT HEALTH HAZARDS, as per MAHC 6.6.3;
- 2) Outline the methods of communication between responders, emergency services, and PATRONS;
- 3) Identify each anticipated responder;
- 4) Outline the tasks of each responder;
- 5) Identify required equipment for each task; and

- 6) Emergency closure requirements.

6.3.3.2.1^A *Coordination of Response* When one or more QUALIFIED LIFEGUARDS are used, the SAFETY PLAN and the EAP shall identify the best means to provide additional persons to rapidly respond to the emergency to help the initial rescuer.

6.3.3.3 *Pre-Service Requirements* The Pre-Service Plan shall include:

- 1) Policies and procedure training specific to the AQUATIC FACILITY,
- 2) Demonstration of SAFETY TEAM skills specific to the AQUATIC FACILITY prior to assuming on-duty lifeguard responsibilities, and
- 3) Documentation of training.

6.3.3.3.1^A *Safety Team EAP Training* Prior to active duty, all members of the SAFETY TEAM shall be trained on, and receive a copy of, and/or have a copy posted and always available of the specific policies and procedures for the following:

- 1) Staffing plan;
- 2) EAP;
- 3) Emergency closure; and
- 4) Fecal, vomit, or blood contamination on surfaces and in the water as outlined in MAHC 6.5.

6.3.3.3.2^A *Safety Team Skills Proficiency* Prior to active duty, all members of the SAFETY TEAM shall demonstrate knowledge and skill competency specific to the AQUATIC FACILITY for the following criteria:

- 1) Understand their responsibilities and of others on the AQUATIC FACILITY SAFETY TEAM,
- 2) Ability to execute the EAP,
- 3) Know what conditions require closure of the facility, and
- 4) Know what actions to take in response to a fecal, vomit, or blood contamination on a surface and in the water as outlined in MAHC 6.5.

6.3.3.3.3^A *Qualified Lifeguard Emergency Action Plan Training* When QUALIFIED LIFEGUARDS are used, they shall be trained on the EAP and receive a copy of or have a copy of the EAP posted and always available at the AQUATIC FACILITY, specifically including policies and procedures for the following:

- 1) Zone of PATRON surveillance plan,
- 2) Rotation plan,
- 3) Minimum staffing plan, and
- 4) Rescue / first aid response plan.

6.3.3.3.4^A *Qualified Lifeguard Skills Proficiency* When QUALIFIED LIFEGUARDS are used, they shall demonstrate knowledge and skill competency specific to the AQUATIC FACILITY for the following criteria:

- 1) Ability to reach the bottom at the maximum water depth of the AQUATIC VENUE to be assigned;
- 2) Ability to identify all zones of BATHER surveillance responsibility to which they could be assigned;
- 3) Ability to recognize a victim in their assigned zone of BATHER surveillance;
- 4) Ability to reach the furthest edge of assigned zones of BATHER surveillance within 20 seconds;

- 5) Water rescue skills outlined in MAHC 6.2.1.1.2;
- 6) CPR/AED and first aid;
- 7) Ability to execute EAP;
- 8) Emergency closure issues; and
- 9) Fecal, vomit, or blood contamination incident response as outlined in MAHC 6.5.

6.3.3.3.5 *CPR / AED and First Aid Certificate* The designated person(s) with CPR/AED and first aid training shall present unexpired certificate(s) as per MAHC 6.2.1.1.3 and 6.2.1.1.4 prior to active duty.

6.3.3.3.5.1 *Copies Maintained* Originals or copies of certificates shall be maintained at the AQUATIC FACILITY and be available for inspection.

6.3.3.3.6^A *Documentation of Pre-Service Training* Documentation verifying the pre-service requirements shall be completed by the person conducting the pre-service training, maintained at the facility for 3 full years, and be available for inspection.

6.3.3.3.6.1 *Lifeguard Certificate* When QUALIFIED LIFEGUARDS are used, they shall present an unexpired certificate as per MAHC 6.2.1.3.4 prior to assuming on-duty lifeguard responsibilities.

6.3.3.3.6.2 *Copies Maintained* Originals or copies of certificates shall be maintained at the facility and be available for inspection.

6.3.3.4 *In-Service Training* During the course of their employment, AQUATIC FACILITY staff shall participate in periodic in-service training to maintain their skills.

6.3.3.4.1^A *Documentation of In-Service Training* Documentation verifying the in-service requirements shall be completed by the person conducting the in-service training, maintained at the AQUATIC FACILITY for 3 years, and available for inspection.

6.3.3.4.2^A *In-Service Documentation* Documentation shall include:

- 1) Names of attendees,
- 2) Content of training,
- 3) Date of training, and
- 4) Name of the trainer(s).

6.3.3.4.3^A *In-Service Training Plan* The in-service training plan shall include:

- 1) In-service training frequency,
- 2) Documentation of in-service training,
- 3) Maintenance of certifications, and
- 4) Demonstration of test-ready skills.

6.3.3.4.4 *Maintain Certificates* The designated person(s) with CPR/AED and first aid training shall maintain certifications to show the following:

- 1) CPR/AED training is completed annually and certificates are unexpired, and
- 2) First aid training certificates are unexpired.

6.3.3.4.5^A *Competency Demonstration* When QUALIFIED LIFEGUARDS are used, they shall be able to demonstrate proficiency in the skills as outlined by MAHC 6.2.1 and have the ability to perform the following water rescue skills consecutively so as to demonstrate the ability to respond to victim and complete the rescue:

- 1) Reach the furthest edge of zones of BATHER surveillance within 20 seconds;
- 2) Recover a simulated victim, including extrication to a position of safety consistent with MAHC 6.2.1.1.2; and
- 3) Perform resuscitation skills consistent with MAHC 6.2.1.1.3.

6.3.3.5^A AHJ Authority to Approve Safety Plan The AHJ shall have the authority, if they so choose, to require:

- 1) Submittal of the SAFETY PLAN for archiving and reference or
- 2) Submittal of the SAFETY PLAN for review and approval prior to opening to the public.

6.3.3.5.1^A Safety Plan on File The SAFETY PLAN shall be kept on file at the AQUATIC FACILITY.

6.3.3.5.2^A Safety Plan Implemented The elements detailed in the SAFETY PLAN shall be implemented and in evidence in the AQUATIC FACILITY operation and is subject to review for compliance by the AHJ at any time.

6.3.4 Staff Management

6.3.4.1 Staff Provided Prior to Aquatic Venue Use Prior to use of any AQUATIC VENUE, the AQUATIC FACILITY shall provide staff required per the provisions of the SAFETY PLAN as stated in MAHC 6.3.2.

6.3.4.2 Safety Team Responsibilities SAFETY TEAM responsibilities shall include but not be limited to:

- 1) Enforce the AQUATIC FACILITY rules and regulations by interfacing with PATRONS,
- 2) Respond to reported emergencies,
- 3) Identify health and SAFETY hazards and take action to mitigate or avoid the hazard,
- 4) Know where PPE is located and use it when required, and
- 5) Interface with the AHJ related to the requirements of this CODE.

6.3.4.3 Lifeguard Staff

6.3.4.3.1^A Minimum Number of Lifeguards Where QUALIFIED LIFEGUARDS are used, the AQUATIC FACILITY shall provide, prior to opening the AQUATIC FACILITY to the public, the minimum number of QUALIFIED LIFEGUARDS and staff required per the provisions of the SAFETY PLAN such that:

- 1) All zones of PATRON surveillance are staffed during operation;
 - a. Zones of PATRON surveillance for individual AQUATIC VENUES not open for use, must also be staffed unless an effective means is provided to restrict and MONITOR access to the AQUATIC VENUE;
- 2) Rotations can be conducted while all zones are staffed;
- 3) LIFEGUARD SUPERVISOR, where required by MAHC 6.3.4.4.1, is present; and
- 4) Additional person(s) to rapidly respond to an emergency to help the initial rescuer, as required in MAHC 6.3.3.2.1, are present.

6.3.4.3.2^A Lifeguard Responsibilities QUALIFIED LIFEGUARD responsibilities shall include but not be limited to:

- 1) MONITOR PATRONS within the zone of PATRON surveillance responsibility;
- 2) Enforce facility rules;

- 3) Respond to emergencies including water rescue, CPR, AED use if equipment is provided with established local protocols, and first aid;
- 4) Identify health and SAFETY hazards and take action to mitigate or avoid the hazard;
- 5) Maintain skills at a test-ready level of proficiency;
- 6) Wear the identifying uniform;
- 7) If needed for effective PATRON surveillance, wear corrective eyewear as necessary to correct poor vision and wear polarized sunglasses;
- 8) If exposed to UV, wear SPF 15 or greater UV protection; and
- 9) Know where PPE is located and use it when required.

6.3.4.3.3^A *Shallow Water Certified Lifeguards* QUALIFIED LIFEGUARDS certified for shallow water depths shall not be assigned to a BODY OF WATER in which any part of the water's depth is greater than the depth for which they are certified.

6.3.4.3.4^A *Direct Surveillance* QUALIFIED LIFEGUARDS assigned responsibilities for PATRON surveillance shall not be assigned other tasks that intrude on PATRON surveillance while performing those surveillance activities.

6.3.4.3.5^A *Distractions* While conducting BATHER surveillance, QUALIFIED LIFEGUARDS shall not engage in social conversations or have on their person or lifeguard station, reading materials, cellular telephones, texting devices, music players, or other similar non-emergency electronic devices.

6.3.4.4 Supervisor Staff

6.3.4.4.1^A *Lifeguard Supervisor Required* AQUATIC FACILITIES that are required to have two or more QUALIFIED LIFEGUARDS to satisfy Zone responsibilities per the Zone Plan of BATHER Surveillance in MAHC 6.3.3.1.1, shall have an additional person at the AQUATIC FACILITY during all hours of operation designated as the LIFEGUARD SUPERVISOR who meets the requirement of MAHC 6.2.2.

6.3.4.4.2^A *Designated Supervisor* One of the QUALIFIED LIFEGUARDS as per MAHC 6.3.3.1.1 may be designated as the LIFEGUARD SUPERVISOR in addition to fulfilling the duties of QUALIFIED LIFEGUARD.

6.3.4.4.2.1 *Lifeguard Supervisor Duties* LIFEGUARD SUPERVISOR duties shall not interfere with the primary duty of PATRON surveillance.

6.3.4.4.3 *Lifeguard Supervisor* LIFEGUARD SUPERVISOR responsibilities shall include but not be limited to:

- 1) MONITOR performance of QUALIFIED LIFEGUARDS in their zone of BATHER surveillance responsibility,
- 2) Make sure the rotation is conducted in accordance with the SAFETY PLAN,
- 3) Coordinate staff response and BATHER care during an emergency,
- 4) Identify health and SAFETY hazards and communicate to staff and management to mitigate or otherwise avoid the hazard, and
- 5) Make sure the required equipment per MAHC 5.8.5 is in place and in good condition.

6.3.4.5 Emergency Response and Communications Plans

6.3.4.5.1^A *Emergency Response and Communication Plan* AQUATIC FACILITIES shall create and maintain an operating procedure manual containing information on the emergency response and communications plan including an EAP, Facility Evacuation Plan, and Inclement Weather Plan.

6.3.4.5.2 *Emergency Action Plan* A written EAP shall be developed, maintained, and updated as necessary for the AQUATIC FACILITY.

6.3.4.5.3 *Annual Review and Update* The EAP shall be reviewed with the AQUATIC FACILITY staff and management annually or more frequently as required when changes occur with the dates of the review recorded in the EAP.

6.3.4.5.4 *Available for Inspection* The written EAP shall be kept at the AQUATIC FACILITY and available for emergency personnel and/or AHJ upon request.

6.3.4.5.5^A *Training Documentation* Documentation from employees trained in current EAP shall be available upon request.

6.3.4.5.6 *Components* The EAP shall include at a minimum:

- 1) A diagram of the AQUATIC FACILITY;
- 2) A list of emergency telephone numbers;
- 3) The location of first aid kit and other rescue equipment (*BVM, AED, if provided, backboard, etc.*);
- 4) An emergency response plan for accidental chemical release; and
- 5) A fecal/vomit/blood CONTAMINATION RESPONSE PLANS as outlined in MAHC 6.5.1.

6.3.4.5.6.1 *Accidental Chemical Release Plan* The accidental chemical release plan shall include procedures for:

- 1) How to determine when professional hazardous materials (HAZMAT) response is needed,
- 2) How to obtain it,
- 3) Response and cleanup,
- 4) Provision for training staff in these procedures, and
- 5) A list of equipment and supplies for cleanup.

6.3.4.5.6.2 *Remediation Supplies* The availability of equipment and supplies for remediation procedures shall be verified by the operator at least weekly.

6.3.4.5.7 *Facility Evacuation Plan* A written Facility Evacuation Plan shall be developed and maintained for the facility.

6.3.4.5.7.1 *Evacuation Plan Components* This plan shall include at a minimum:

- 1) Actions to be taken in cases of drowning, serious illness or injury, chemical handling accidents, weather emergencies, and other serious incidents; and
- 2) Defined roles and responsibilities for all staff.

6.3.4.5.8^A *Communication Plan* A communication plan shall exist to facilitate activation of internal emergency response centers and/or community 911/EMS as necessary.

6.3.4.5.8.1 *Communication Plan Components* At a minimum, this plan shall include:

- 1) Provision and use of readily accessible, appropriate communication devices such as telephones, call boxes, and mobile devices;
- 2) Signage;
- 3) Procedures to be followed during staffed and unstaffed time periods;
- 4) Acceptable alternative communication during loss of power; and
- 5) Training of all personnel.

6.3.4.5.8.2^A *Notification Procedures* The communication plan shall include a plan for notification to federal or tribal; state or territorial; and local agencies in case of a chemical spill that exceeds

the EPA reportable quantity.

6.3.4.5.9^A ***Inclement Weather Plan*** AQUATIC FACILITIES shall have a contingency/response plan for localized weather events that may affect their operation (*i.e., lightning, hurricanes, tornados, high winds, etc.*).

6.3.4.5.9.1 ***Contingency Plan*** Contingency plans shall include training for employees, evacuation procedures, and determining when it is acceptable to reopen a facility for operation.

6.3.4.6^A ***Remote Monitoring Systems***

6.3.4.6.1^A ***Lifeguard-Based*** Lifeguard-based remote SAFETY MONITORING systems shall not replace the need for QUALIFIED LIFEGUARDS.

6.3.4.6.1.1 ***No Substitute*** Remote SAFETY MONITORING systems may be used to aid the operation but not as a substitute for QUALIFIED LIFEGUARDS/SLIDE operators when critical areas such as blind spots in an AQUATIC VENUE or area of a SLIDE cannot be viewed by QUALIFIED LIFEGUARDS/SLIDE operators.

6.3.4.6.2^A ***Operator-Based*** QUALIFIED OPERATOR-based remote water quality MONITORING systems shall not be a substitute for manual water quality testing of the AQUATIC VENUE.

6.3.4.6.3 ***Training*** When QUALIFIED LIFEGUARD- or QUALIFIED OPERATOR-based remote MONITORING systems are used, AQUATIC FACILITY staff shall be trained on their use, limitations, and communication and response protocols for communications with the MONITORING group.

6.3.4.7^A ***Employee Illness and Injury Policy***

6.3.4.7.1 ***Illness Policy*** Supervisors shall not permit employees who are ill with diarrhea to enter the water or perform in a QUALIFIED LIFEGUARD role.

6.3.4.7.2 ***Open Wounds*** Supervisors shall permit employees with open wounds in the water or in a QUALIFIED LIFEGUARD role only if they have healthcare provider approval or wear a waterproof, occlusive bandage to cover the wound.

6.4^A Aquatic Facility Management

6.4.1 Operations

6.4.1.1 Operations Manual

6.4.1.1.1^A ***Develop*** Each AQUATIC FACILITY shall develop an operations manual to keep at the AQUATIC FACILITY in both printed and electronic formats.

6.4.1.1.2^A ***Include*** The manual shall at minimum include, but not be limited to the following items:

- 1) AQUATIC VENUE and AQUATIC FEATURE description(s) and locations,
- 2) Facility communication,
- 3) List of chemicals and system information,
- 4) Fecal/vomit/blood CONTAMINATION RESPONSE PLANS,
- 5) Preventive maintenance plan, and
- 6) Any other STANDARD operation and maintenance policies and instructions or applicable information for each AQUATIC VENUE and AQUATIC FEATURE at the facility.

6.4.1.2 ***Operation Records*** AQUATIC FACILITIES shall keep records pertaining to the operation, maintenance, and management of the AQUATIC FACILITY on a minimum schedule as prescribed under MAHC 6.4.1.2.

6.4.1.2.1 ***Record Maintenance*** AQUATIC FACILITY records shall be:

- 1) Kept for a minimum of 3 years and
- 2) Available upon request by the AHJ.

6.4.1.2 Additional Documentation Applicable local, state, territorial, federal, or tribal laws may require additional records, documentation, and forms.

6.4.1.3 Safety and Maintenance Inspection and Recordkeeping The QUALIFIED OPERATOR or RESPONSIBLE SUPERVISOR shall ensure that SAFETY and preventive maintenance inspections are done at the AQUATIC FACILITY during seasons or periods when the AQUATIC FACILITY is open and that the results are recorded in a log or form maintained at the AQUATIC FACILITY.

6.4.1.3.1 Daily Inspection Items The QUALIFIED OPERATOR or RESPONSIBLE SUPERVISOR shall ensure that a daily AQUATIC FACILITY preventive maintenance inspection is done before opening and that it shall include:

- 1) Walkways/DECK and exits are clear, clean, free of debris;
- 2) Drain covers, vacuum fitting covers, SKIMMER equalizer covers, and any other suction outlet covers are in place, secure, and unbroken;
- 3) SKIMMER baskets, weirs, lids, flow adjusters, and suction outlets are free of any blockage;
- 4) INLET and return covers and any other fittings are in place, secure, and unbroken;
- 5) Safety warning signs and other signage are in place and in good repair;
- 6) Safety equipment as required by this CODE are in place and in good repair, including emergency instructions and phone numbers;
- 7) Entrapment prevention systems are operational;
- 8) Recirculation, DISINFECTION systems, controller(s), and probes are operating as required;
- 9) SECONDARY TREATMENT and/or SUPPLEMENTAL TREATMENT systems are operating as required;
- 10) Underwater lights and other lighting are intact with no exposed wires or water in lights;
- 11) Slime and biofilm have been removed from accessible surfaces of AQUATIC VENUES, SLIDES, and other AQUATIC FEATURES;
- 12) Doors to nonpublic areas (*CHEMICAL STORAGE SPACES, offices, etc.*) are locked;
- 13) First aid supplies are stocked;
- 14) Emergency communication equipment and systems are operational;
- 15) Fecal/vomit/blood incident CONTAMINATION RESPONSE PLANS, materials, and equipment are available;
- 16) Water features and amenities are functioning in accordance with the manufacturer's recommendations;
- 17) Fencing/ENCLOSURES, gates, and self-latching or other locks are tested and are intact and functioning properly, and ENCLOSURES do not have nearby furniture to encourage climbing;
- 18) Drinking fountains are clean and in functional condition;
- 19) Electrical devices are in good working condition and meet the requirements specified in the MAHC;
- 20) Alarms, if required, are tested and functioning properly; and
- 21) Assessing water clarity such that the bottom and objects in the POOL are clearly visible.

6.4.1.3.2 Other Inspection Items The QUALIFIED OPERATOR or RESPONSIBLE SUPERVISOR shall ensure that the AQUATIC FACILITY preventive maintenance inspections shall also include:

- 1) Monthly tests of GFCI devices and

- 2) Visual inspections of bonding conductors, where accessible, every 6 months or whenever disrupted or impacted by site construction or other related events.

6.4.1.4^A Illness and Injury Incident Reports

6.4.1.4.1 Incidents to Record The owner/operator shall ensure that a record is made of all injuries and illness incidents at the AQUATIC FACILITY which:

- 1) Result in death;
- 2) Require resuscitation, CPR, oxygen, or AED use to be initiated;
- 3) Require transportation or treatment of a PATRON to a medical facility; or
- 4) Results in a PATRON being diagnosed with a RWI.

6.4.1.4.2 Info to Include Illness and injury incident report information shall include

- 1) Date,
- 2) Time,
- 3) Location,
- 4) Incident including type of illness or injury and cause or mechanism,
- 5) Names and addresses of the individuals involved,
- 6) Actions taken,
- 7) Equipment used, and
- 8) Outcome of the incident.

6.4.1.4.3^A Notify the AHJ In addition to making such records, the owner/operator shall ensure that the AHJ is notified within 24 hours of the occurrence of an incident recorded in MAHC 6.4.1.4.1.

6.4.1.4.4^A Lifeguard Rescue Records The owner/operator shall also record all lifeguard rescues where the QUALIFIED LIFEGUARD enters the water and activates the aquatic EAP.

6.4.1.4.4.1 Info to Include These records shall include the date, time, QUALIFIED LIFEGUARD, and PATRON names and reason the rescue was needed.

6.4.1.5 Chemical Inventory Log A chemical inventory log shall be maintained onsite to provide a list of chemicals used in the AQUATIC VENUE water and surrounding DECK that could result in water quality issues, chemical interactions, or PATRON exposure.

6.4.1.5.1 Expiration Dates These records shall include the expiration date for water quality chemical testing reagents.

6.4.1.6^A Daily Water Monitoring and Testing Records Daily, or as often as required, MONITORING and testing records shall include, but are not limited to the following:

- 1) pH;
- 2) Disinfectant residuals;
- 3) COMBINED CHLORINE concentrations;
- 4) Operating pressures of water recirculation pumps and filters or the corresponding flow rate from flow meter readings;
- 5) CYA levels, if used;
- 6) Maintenance and malfunctioning of equipment, including dates and time of all equipment calibration including WQTDs;

- 7) Dates of challenge testing of the chemical feeder interlock system as outlined in MAHC 5.7.3.5.1.4.1;
- 8) If heated, AQUATIC VENUE water temperature;
- 9) The time of filter backwash or cleaning;
- 10) Calcium hardness;
- 11) Total alkalinity;
- 12) Saturation index;
- 13) Microbiological testing, if applicable, dates/times samples were taken and results;
- 14) Any equipment failure, power outage, or error resulting in the interruption of the circulation, filtration, or DISINFECTION systems for more than 1 hour;
- 15) The daily attendance at the AQUATIC FACILITY. In POOLS where attendance is not ordinarily recorded, a guest sign in book can be used to track attendance; and
- 16) SECONDARY TREATMENT as outlined in MAHC 5.7.3.7.7 and 5.7.3.7.8.

6.4.1.7 Staff Certifications on File The originals or copies of all required QUALIFIED LIFEGUARD, LIFEGUARD SUPERVISOR, or QUALIFIED OPERATOR certificates shall be maintained at the AQUATIC FACILITY and made available to AHJ, staff, and PATRONS upon request.

6.4.1.7.1 Multiple Facilities A copy of the original certificate shall be made available when employees work at multiple AQUATIC FACILITIES.

6.4.1.8^A Bodily Fluids Remediation Log

6.4.1.8.1^A Contamination Incidents A Body Fluid Contamination Response Log shall be maintained to document each occurrence of contamination of the water or its immediately adjacent areas by formed or diarrheal fecal material, whole stomach discharge of vomit, and blood.

6.4.1.8.2 Standard Operating Procedures The AQUATIC FACILITY'S STANDARD operating procedures for responding to these contamination incidents shall be readily available for review by the AHJ.

6.4.1.8.3 Required Information The log shall include the following information recorded at the time of the incident:

- 1) Person conducting response;
- 2) Qualified operator or onsite responsible supervisor on duty;
- 3) Date and time of incident response;
- 4) Specific area, if not in the water, contaminated by incident;
- 5) BATHER COUNT or reasonable approximation of the number of BATHERS in the AQUATIC VENUE at the time of incident (*if applicable*);
- 6) Type and form of body fluid observed (*for example, diarrheal or formed stool, vomit, or blood*);
- 7) Date and time when the area was closed;
- 8) Whether the POOL uses CHLORINE stabilizer and concentration at time of incident;
- 9) Residual disinfectant (*e.g., DPD-FC*) concentration and pH at the time of incident;
- 10) Remediation procedures used after the incident including contact time, if applicable;
- 11) Residual disinfectant (*e.g., DPD-FC*) concentration and pH at the time of reopening the AQUATIC VENUE to the public;
- 12) Stabilizer concentration, if used, at the time of reopening; and

13) Date and time of reopening.

6.4.2 Patron-Related Management Aspects

6.4.2.1 Bather Count

6.4.2.1.1^A User Guidance AQUATIC FACILITIES shall have a plan in place to address fluctuations in BATHER occupancy to ensure proper maintenance and staffing.

6.4.2.1.2 Maximum Occupancy Such plans shall not exceed the maximum designed THEORETICAL PEAK OCCUPANCY for the individual AQUATIC VENUES or the AQUATIC FACILITY.

6.4.2.2^A Signage

6.4.2.2.1 Facility Rules The operator shall post and enforce the AQUATIC FACILITY rules governing health, SAFETY, and sanitation.

6.4.2.2.2 Lettering The lettering shall be legible and at least 1 inch (25.4 mm or 3- point type) high, with a contrasting background.

6.4.2.2.3^A Sign Messages Signage shall be placed in a conspicuous place at the entrance of the AQUATIC FACILITY communicating expected and prohibited behaviors and other information using text that complies with the intent of the following information:

- 1) In case of an emergency, dial 911 or other emergency instructions, per MAHC 6.3.4.5.8;
- 2) Hours of operation;
- 3) Theoretical peak occupancy;
- 4) Pollution of AQUATIC VENUE prohibited;
- 5) Do not swim if you have open wounds;
- 6) Do not swim if you are ill with diarrhea or have had diarrhea within the past 2 weeks;
- 7) SHOWER before entering the water;
- 8) No glass items in the AQUATIC VENUE or on the DECK;
- 9) Do not swallow or spit water;
- 10) Diaper changing on the DECK is prohibited;
- 11) No Diving, as applicable per MAHC 5.5.5;
- 12) Intentional hyperventilation or extended breath holding activities are dangerous and prohibited;
- 13) No animals in the AQUATIC VENUE and no animals on the DECK, except service animals, if applicable;
- 14) No rough play; and
- 15) Children must be supervised by a responsible adult (parent or caregiver) up to the minimum age established by the AQUATIC FACILITY.

6.4.2.2.3.1 Aquatic Facilities with Onsite Emergency Personnel MAHC 6.4.2.2.3 signage requirement number 1 may be amended to include onsite emergency staff contact information if emergency trained personnel are onsite so that the response would be faster than calling 911.

6.4.2.2.3.2 Diving Well AQUATIC FACILITIES with diving wells may amend signage requirement number 11 to read that diving is not allowed in all AQUATIC VENUES except for the diving well.

6.4.2.2.3.3 Posters Recreational water illness prevention posters shall be posted conspicuously in the AQUATIC FACILITY at all times.

6.4.2.2.3.4 Unstaffed Aquatic Facilities without Lifeguards In addition to signage messages 1

through 13, unstaffed AQUATIC FACILITIES shall also include signage messages covering:

- 1) No Lifeguard on Duty: Children under the age of 14 years must have direct supervision by a person aged 18 years or older and
- 2) Hours of operation: AQUATIC FACILITY use prohibited at any other time.

6.4.2.2.3.4.1 Posters In AQUATIC FACILITIES not requiring lifeguards, CPR posters reflecting the latest STANDARDS shall be posted conspicuously at all times.

6.4.2.2.3.5 Multiple Aquatic Venues For AQUATIC FACILITIES with multiple AQUATIC VENUES, MAHC 6.4.2.2.3 signage item numbers 3 and, if applicable, number 11, or text complying with the intent of the information, shall be posted at the entrance to each AQUATIC VENUE except such posting is not required at WATERSLIDES.

6.4.2.2.3.6 Movable Bottom Floor Signage In addition to the MAHC 6.4.2.2.3 requirements, AQUATIC VENUES with moveable bottom floors shall also have the following information or text complying with the intent of the following information:

- 1) A sign for AQUATIC VENUE water depth in use shall be provided and clearly visible;
- 2) A "NO DIVING" sign shall be provided; and
- 3) The floor is movable and AQUATIC VENUE depth varies.

6.4.2.2.3.7^A Spa Signs In addition to the MAHC 6.4.2.2.3 requirements, SPAS shall also have the following information or text complying with the intent of the following information:

- 1) Maximum water temperature is 104° F (40°C);
- 2) Children under age 5 and people using alcohol or drugs that cause drowsiness shall not use SPAS;
- 3) Pregnant women and people with heart disease, high blood pressure or other health problems should not use SPAS without prior consultation with a healthcare provider;
- 4) Children under 14 years of age shall be supervised by an adult; and
- 5) Use of the SPA when alone is prohibited (*if no lifeguards onsite*).

6.4.2.2.4 Hygiene Facility Signage Signage shall be posted at the HYGIENE FACILITY exit used to access AQUATIC VENUES stating or containing information, or text complying with the intent of the following information:

- 1) Do not swim when ill with diarrhea;
- 2) Do not swim with open wounds and sores;
- 3) SHOWER before entering the water;
- 4) Check your child's swim diapers/rubber pants regularly;
- 5) Diaper changing on the DECK is prohibited;
- 6) Do not poop or pee in the water;
- 7) Do not swallow or spit water; and
- 8) Wash hands before returning to the POOL.

6.4.2.2.5^A Diaper-Changing Station Signage Signage shall be posted at DIAPER-CHANGING STATIONS stating or containing information, or text complying with the intent of the following information:

- 1) Dispose of used disposable diapers in the diaper bucket or receptacle provided;
- 2) Dump contents from reusable diapers into toilets and bag diapers to take home;

- 3) Use the materials provided to clean/SANITIZE the surface of the DIAPER-CHANGING STATION before and after each use;
- 4) Wash your hands and your child's hands after diapering; and
- 5) Do not swim if ill with diarrhea.

6.4.2.3 Swimmer Empowerment Methods

6.4.2.3.1^A Public Information and Health Messaging The owner/operator shall ensure that a public information and health messaging program to inform INDOOR AQUATIC FACILITY PATRONS of their impact on INDOOR AQUATIC FACILITY air quality is developed and implemented.

6.4.2.3.2^A Post Inspection Results The results of the most recent AHJ inspection of the AQUATIC FACILITY shall be posted at the AQUATIC FACILITY in a location conspicuous to the public.

6.5^A Fecal/Vomit/Blood Contamination Response

6.5.1^A Contamination Response Plan

6.5.1.1 Contamination Response Plan All AQUATIC FACILITIES shall have a CONTAMINATION RESPONSE PLAN within the EAP for responding to formed-stool contamination, diarrheal-stool contamination, vomit contamination, and contamination involving blood.

6.5.1.2 Contamination Training The CONTAMINATION RESPONSE PLAN shall include procedures for response and cleanup, provisions for training staff in these procedures, and a list of equipment and supplies for cleanup.

6.5.1.2.1^A Minimum A minimum of one person onsite while the AQUATIC FACILITY is open for use shall be:

- 1) Trained in the procedures for response to formed-stool contamination, diarrheal contamination, vomit contamination, and blood contamination and
- 2) Trained in PPE and other OSHA measures including the Bloodborne Pathogens Standard 29 CFR 1910.1030 to minimize exposure to bodily fluids that may be encountered as employees in an aquatic environment.

6.5.1.2.2 Informed Staff shall be informed of any updates to the response plan.

6.5.1.3 Equipment and Supply Verification The availability of equipment and supplies for remediation procedures shall be verified by the QUALIFIED OPERATOR at least weekly.

6.5.1.4 Plan Review The response plan shall be reviewed at least annually and updated as necessary.

6.5.1.5 Plan Availability The response plan shall be kept onsite and available for viewing by the AHJ.

6.5.2 Aquatic Venue Water Contamination Response

6.5.2.1 Closure In the event of a fecal or vomit contamination in an AQUATIC VENUE, the QUALIFIED OPERATOR shall immediately close the AQUATIC VENUE to swimmers until remediation procedures are complete.

6.5.2.1.1 Closure Includes This closure shall include the affected AQUATIC VENUE and other AQUATIC VENUES that share the same RECIRCULATION SYSTEM.

6.5.2.2 Physical Removal Contaminating material shall be removed (*e.g., using a net, scoop, or bucket*) and disposed of in a sanitary manner.

6.5.2.2.1 Clean / Disinfect Net or Scoop Fecal or vomit contamination of the item used to remove the contamination (*e.g., the net or bucket*) shall be removed by thorough cleaning followed by

DISINFECTION (e.g., after cleaning, leave the net, scoop, or bucket immersed in the POOL during the DISINFECTION procedure prescribed for formed-stool, diarrheal-stool, or vomit contamination, as appropriate).

6.5.2.2.2^A **No Vacuum Cleaners** Aquatic vacuum cleaners shall not be used for removal of contamination from the water or adjacent surfaces unless vacuum waste is discharged to a sanitary sewer and the vacuum equipment can be adequately disinfected.

6.5.2.3^A **Treated** AQUATIC VENUE water that has been contaminated by feces or vomit shall be treated as follows:

- 1) Check to ensure that the water's pH is 7.5 or lower and adjust if necessary;
- 2) Verify and maintain water temperature at 77°F (25°C) or higher;
- 3) Operate the filtration/RECIRCULATION SYSTEM while the POOL reaches and maintains the proper DPD-FC concentration during the remediation process;
- 4) Test the FREE CHLORINE RESIDUAL at multiple sampling points to ensure the proper DPD-FC concentration is achieved throughout the POOL for the entire DISINFECTION time; and
- 5) Use only non-stabilized CHLORINE products to raise the DPD-FC concentrations during the remediation.

6.5.3 Aquatic Venue Water Contamination Disinfection

6.5.3.1^A **Formed-Stool Contamination** Formed-stool contaminated water shall have the DPD-FC concentration checked and the DPD-FC concentration raised to 2.0 ppm (mg/L) (if less than 2.0 ppm [mg/L]) and maintained for at least 25 minutes (or an equivalent time and concentration to reach the CT INACTIVATION VALUE) before reopening the AQUATIC VENUE.

6.5.3.1.1^A **Pools Containing Chlorine Stabilizers** In AQUATIC VENUE water that contains CYA or a stabilized CHLORINE product, water shall be treated by doubling the inactivation time required under MAHC 6.5.3.1.

6.5.3.1.2 **Measurement of Inactivation Time** Measurement of the inactivation time required shall start when the AQUATIC VENUE reaches the intended DPD-FC concentration.

6.5.3.2^A **Diarrheal-Stool Contamination** Diarrheal-stool contaminated water shall:

- 1) Check the DPD-FC concentration and then raise the DPD-FC concentration to 20.0 ppm (mg/L) and maintain for at least 12.75 hours (or an equivalent time and concentration to reach the CT INACTIVATION VALUE) before reopening the AQUATIC VENUE or
- 2) Circulate the water through a SECONDARY TREATMENT to theoretically reduce the number of *Cryptosporidium* OOCYSTS in the AQUATIC VENUE below one OOCYST/100 mL as outlined in MAHC 4.7.3.3.2.4.

6.5.3.2.1^A **Pools Containing Chlorine Stabilizers** In AQUATIC VENUE water that contains CYA or a stabilized CHLORINE product, water shall be treated by:

- 1) HYPERCHLORINATION accomplished by:
 - a. Following the preparatory guidance outlined in MAHC 6.5.2.3;
 - b. Lowering the CYA concentration to less than or equal to 15 ppm (mg/L) by draining, if necessary;
 - c. Raising the DPD-FC concentration to 20 ppm (mg/L) for at least 28 hours; 30 ppm (mg/L) for at least 18 hours; or 40 ppm (mg/L) for at least 8.5 hours, which is needed to reach the CT INACTIVATION VALUE; and
 - d. Measuring the inactivation time required, which shall start when the AQUATIC VENUE reaches the intended DPD-FC concentration or;

- 2) Circulating the water through a SECONDARY TREATMENT to theoretically reduce the number of *Cryptosporidium* OOCYSTS in the AQUATIC VENUE below one OOCYST/100 mL as outlined in MAHC 4.7.3.3.2.4 or;
- 3) Draining the AQUATIC VENUE completely.

6.5.3.3^A Vomit-Contamination Vomit-contaminated water shall have the DPD-FC concentration checked and the DPD-FC concentration raised to 2.0 ppm (*mg/L*) (*if less than 2.0 mg/L*) and maintained for at least 25 minutes (*or an equivalent time and concentration to reach the CT INACTIVATION VALUE*) before reopening the AQUATIC VENUE.

6.5.3.3.1 Pools Containing Chlorine Stabilizers In AQUATIC VENUE water that contains CYA or a stabilized CHLORINE product, water shall be treated by doubling the inactivation time required under MAHC 6.5.3.3.

6.5.3.3.2 Measurement of the Inactivation Time Measurement of the inactivation time required shall start when the AQUATIC VENUE reaches the intended DPD-FC concentration .

6.5.3.4^A Blood-Contamination Blood contamination of a properly maintained AQUATIC VENUE'S water does not pose a public health risk to swimmers.

6.5.3.4.1 Operators Choose Treatment Method Operators may choose whether or not to close the AQUATIC VENUE and treat as a formed stool contamination as in MAHC 6.5.3.1 to satisfy PATRON concerns.

6.5.3.5^A Procedures for Brominated Pools Formed-stool, diarrheal-stool, or vomit-contaminated water in a brominated AQUATIC VENUE shall have CHLORINE added to the AQUATIC VENUE in an amount that will increase the DPD-FC concentration to the level specified for the specific type of contamination for the specified time.

6.5.3.5.1 Bromine Residual The bromine residual shall be adjusted, if necessary, before reopening the AQUATIC VENUE.

6.5.3.6^A Legionella Contamination

6.5.3.6.1 Remediation and Testing For remediation and testing of AQUATIC VENUES suspected of being contaminated with *Legionella* the QUALIFIED OPERATOR shall:

- 1) Close the SPA tub to BATHERS immediately, shut down the hydrotherapy jet system and circulation pumps, but do not drain the water.
- 2) Contact the state or local public health AHJ for information about laboratory testing for *Legionella*. If the health department determines that laboratory testing is needed, water and biofilm samples should be taken from the SPA tub, hydrotherapy jets, drain, and filters/filter media to test for *Legionella* by culture before taking the steps below. Sampling and laboratory testing are complicated and should always be done in collaboration with your state or local public health agency and a laboratory with *Legionella* testing expertise.
- 3) Proceed as directed below after samples have been taken; it is not necessary to wait for laboratory test results. However, the SPA should not be reopened to BATHERS until all test results are negative for *Legionella*.
- 4) Scrub vigorously all SPA surfaces, skimming devices, circulation components with DPD-FC at a minimum concentration of 5 ppm (*mg/L*) to remove any biofilm or slime. After scrubbing, rinse the SPA with clean water and flush to waste.
- 5) Drain all water from the SPA. Dispose of the water to waste or as directed by the local regulatory authority.
- 6) Replace filters (for cartridge or DE filters) or filter media (for sand filters). Bag these filters and dispose as normal solid waste.
- 7) Inspect the SPA thoroughly for any broken or poorly functioning components such as valves, sensors, tubing, or disinfectant feeders. Make any needed repairs.
- 8) Refill the SPA with clean water.

- 9) Hyperchlorinate using 20 ppm (*mg/L*) DPD-FC. a.) Keep the hydrotherapy jet system off and let the hyperchlorinated water circulate for 1 hour in all of the components of the SPA including the compensation/surge tank, filter housing, and piping. b.) Turn on the hydrotherapy jet system to circulate the hyperchlorinated water for 9 additional hours. Ensure that 20 ppm (*mg/L*) of DPD-FC is maintained in the system for the entire 10 hours.
- 10) Flush the entire system to remove the hyperchlorinated water from all equipment prior to repeat sampling.
- 11) Take repeat samples for culture-based laboratory testing to confirm that *Legionella* has been eliminated. Water and biofilm samples should be taken from the SPA tub, hydrotherapy jet system, drain, filters/filter media, and any part of the SPA that originally tested positive for *Legionella*.
- 12) Keep the SPA closed to BATHERS until this repeat testing has confirmed the elimination of *Legionella*. If laboratory testing is positive for *Legionella*, repeat steps 4–11 until all testing is negative for *Legionella*. When all tests are negative, the SPA can be reopened to BATHERS.
- 13) Ensure that halogen (CHLORINE or bromine) concentration and pH meet applicable local, state, territorial, federal, and tribal laws before reopening the SPA to BATHERS. Maintain water quality according to local, state, territorial, federal, and tribal laws.
- 14) If the SPA is associated with an outbreak, the following continued laboratory testing schedule shall be conducted: conduct culture-based testing every 2 weeks for 3 months, then every month for 3 months to ensure complete elimination of *Legionella*. If at any time during this laboratory testing schedule *Legionella* is found, disinfect again and start the testing schedule over. For AQUATIC VENUES that continue to grow *Legionella*, consider hiring a consultant with expertise in *Legionella*.

6.5.4 Surface Contamination Cleaning and Disinfection

6.5.4.1^A Limit Access If a bodily fluid, such as feces, vomit, or blood, has contaminated a surface in an AQUATIC FACILITY, facility staff shall limit access to the affected area until remediation procedures have been completed.

6.5.4.2^A Clean Surface Before DISINFECTION, all visible CONTAMINANT shall be cleaned and removed with disposable cleaning products effective with regard to type of CONTAMINANT present, type of surface to be cleaned, and the location within the facility.

6.5.4.3^A Contaminant Removal and Disposal CONTAMINANT removed by cleaning shall be disposed of in a sanitary manner or as required by law.

6.5.4.4^A Disinfect Surface Contaminated surfaces shall be disinfected with one of the following DISINFECTION solutions:

- 1) A 1:10 dilution of fresh household bleach with water or
- 2) An equivalent EPA-REGISTERED disinfectant that has been approved for body fluids DISINFECTION.

6.5.4.5 Soak The disinfectant shall be left to soak on the affected area for a minimum of 20 minutes or as otherwise indicated on the disinfectant label directions.

6.5.4.6 Remove Disinfectant shall be removed by cleaning and shall be disposed of in a sanitary manner or as required by the AHJ.

6.6 AHJ Inspections

6.6.1^A Inspection Process

6.6.1.1 Inspection Authority The AHJ shall have the right to inspect or investigate the operation and management of an AQUATIC FACILITY.

6.6.1.2 Inspection Scope and Right Upon presenting proper identification, an authorized employee or agent of the AHJ shall have the right to and be permitted to enter any AQUATIC FACILITY or AQUATIC VENUE area, including the recirculation equipment and piping area, at any reasonable time for the purpose of

inspecting the AQUATIC VENUE or AQUATIC FEATURES to do any of the following:

- 1) Inspect, investigate, or evaluate for compliance with this CODE;
- 2) Verify compliance with previously written violation orders;
- 3) Collect samples or specimens;
- 4) Examine, review, and copy relevant documents and records;
- 5) Obtain photographic or other evidence needed to enforce this CODE; or
- 6) Question any person.

6.6.1.3 Based on Risk An AQUATIC FACILITY'S inspection frequency may be amended based on a risk of recreational water injury and illness.

6.6.1.4 Inspection Interference It is a violation of this CODE for a person to interfere with, deny, or delay an inspection or investigation conducted by the AHJ.

6.6.2 Publication of Inspection Forms

6.6.2.1 Inspection Form Publication The AHJ may publish or post on the web or other source the reports of AQUATIC FACILITY inspections.

6.6.3 Imminent Health Hazards

6.6.3.1^A Violations Requiring Immediate Correction or Closure The AHJ shall have the right to order immediate correction or order immediate POOL closure for any of the following IMMINENT HEALTH HAZARDS violations:

- 1) Failure to provide supervision and staffing of the AQUATIC FACILITY as prescribed in MAHC 6.3.4.1;
- 2) Failure to provide the minimum disinfectant residual concentrations listed in MAHC 5.7.3.1;
- 3) AQUATIC VENUES using CHLORINE STABILIZERS where the CYA:DPD-FC ratio exceeds 45:1
- 4) pH below 6.5;
- 5) pH above 8.0;
- 6) Failure to continuously operate the AQUATIC VENUE filtration and DISINFECTION equipment;
- 7) Use of an unapproved or contaminated water supply source for potable water use;
- 8) Unprotected overhead electrical wires within 20 feet horizontally of the AQUATIC VENUE;
- 9) Non GFCI protected electrical receptacles within 20 feet of the inside wall of the AQUATIC VENUE;
- 10) Failure to maintain an emergency lighting source;
- 11) Absence of all required lifesaving equipment on DECK;
- 12) AQUATIC VENUE bottom not visible;
- 13) Total absence of or improper depth markings at an AQUATIC VENUE;
- 14) Plumbing CROSS-CONNECTIONS between the drinking water supply and AQUATIC VENUE water or between sewage system and the AQUATIC VENUE including filter backwash facilities;
- 15) Failure to provide and maintain an ENCLOSURE to prevent unauthorized access to the AQUATIC FACILITY or AQUATIC VENUE when required;
- 16) Use of unapproved chemicals or the application of chemicals by unapproved methods to the AQUATIC VENUE water;
- 17) Broken, unsecured, or missing main drain grate or any submerged suction outlet grate in the AQUATIC

VENUE;

- 18) Number of bathers/patrons exceeds the theoretical peak occupancy;
- 19) Broken glass or sharp objects in AQUATIC VENUE or on DECK area; or
- 20) Any other item determined to be a public health hazard by the AHJ.

6.6.3.1.1 *Low pH Violations* If pH testing equipment does not measure below 6.5, pH must be at or below the lowest value of the test equipment.

6.6.3.1.2 *High pH Violations* If pH testing equipment does not measure above 8.0, pH must be at or above the highest value of the test equipment.

6.6.3.2 **Required Closing** An AQUATIC FACILITY owner, QUALIFIED OPERATOR, or RESPONSIBLE SUPERVISOR of an AQUATIC FACILITY shall close an AQUATIC VENUE for any of the IMMINENT HEALTH HAZARDS in MAHC 6.6.3.1.

6.6.4 Enforcement

6.6.4.1 **Placarding of Pool** Where an IMMINENT HEALTH HAZARD is found and remains uncorrected, the AQUATIC VENUE shall be placarded to prohibit use until the hazard is corrected in order to protect the public health or SAFETY of BATHERS.

6.6.4.2 **Placard Location** When a placard is used, it shall be conspicuously posted at each entrance leading to the AQUATIC VENUE.

6.6.4.2.1 *State Authority* When placed by the AHJ, the placard shall state the authority responsible for its placement.

6.6.4.2.2 *Tampering with Placard* When placed by the AHJ, the placard shall indicate that concealment, mutilation, alteration, or removal of it by any person without permission of the AHJ shall constitute a violation of this CODE.

6.6.4.3 **Operator Follow-up** Within 15 days of the AHJ placarding an AQUATIC FACILITY, the operator of such AQUATIC FACILITY shall be provided with an opportunity to be heard and present proof that continued operation of the facility does not constitute a danger to the public health.

6.6.4.3.1 *Correction of Violation* If the IMMINENT HEALTH HAZARD(S) have been corrected, the operator may contact the AHJ prior to the hearing and request a follow-up inspection.

6.6.4.3.2 *Hearing* The hearing shall be conducted by the AHJ.

6.6.4.4 **Follow-up Inspection** The AHJ shall inspect the premises within two working days of notification that the hazard has been eliminated to remove the placards after verifying correction.

6.6.4.4.1 *Other Evidence of Correction* The AHJ may accept other evidence of correction of the hazard in lieu of inspecting the premises.

6.6.5^A Enforcement Penalties

6.6.5.1 **Liability and Jurisdiction** It shall be a violation for any person to fail to comply with any of the regulations promulgated pursuant to this CODE and as adopted by the AHJ.

6.6.5.1.1 *Failure to Comply* Any person who fails to comply with any such regulation shall be in violation of this CODE.

6.6.5.1.2 *Civil Penalty* For each such offense, violators shall be liable for a potential civil penalty.

6.6.5.2 **Continued Violation** Each day, or any part thereof, during which a willful violation of this CODE exists or persists shall constitute a separate violation of this CODE.

6.6.5.3 **Falsified Documents** Falsifying or presenting to the AHJ falsified documentation and or

certificates shall be a civil violation as specified by the AHJ.

6.6.5.4 Enforcement Process Upon determining that one or more violations of this CODE exists, the AHJ shall cause a written notice of the violation or violations to be delivered to the owner or operator of the AQUATIC FACILITY that is in violation of this CODE.

7.0 Special Venues

The provisions of Chapter 7 (*Special Venues*) apply to construction of a new AQUATIC VENUE or SUBSTANTIAL ALTERATION to an existing AQUATIC VENUE, unless otherwise noted.

Note: Section numbers with superscript “A” (e.g., 7.0^A) denote a corresponding discussion in the Annex to the Model Aquatic Health Code.

7.1^A Floatation Tank Design and Construction

7.1.1 Design and Construction

7.1.1.1^A Design and Construction Only the design and construction provisions contained in MAHC 4.1.10.1 thru 4.1.10.11 apply to construction of a new FLOATATION TANK facility or FLOATATION TANK or SUBSTANTIAL ALTERATION to an existing FLOATATION TANK facility or FLOATATION TANK, unless otherwise noted.

7.1.1.2 Plan Submittal

7.1.1.2.1 Purpose FLOATATION TANK facility construction plans shall be designed to provide sufficient clarity to indicate the location, nature, and extent of the work proposed.

7.1.1.2.2 Conform FLOATATION TANK facility construction plans shall show in detail that it will conform to the provisions of this CODE and all applicable local, state, territorial, federal, and tribal laws as determined by the AHJ and to protect the health and SAFETY of the AQUATIC FACILITY’S BATHERS and PATRONS.

7.1.1.2.3 Approved Plans No person shall begin to construct a new FLOATATION TANK facility or shall substantially alter an existing FLOATATION TANK facility without first having the construction plans detailing the construction or SUBSTANTIAL ALTERATION submitted to and approved by the AHJ.

7.1.1.2.4 Plan Preparation All plans shall be prepared by a DESIGN PROFESSIONAL who is registered or licensed to practice their respective design profession as defined by the local, state, territorial, federal, and tribal laws governing professional practice within the jurisdiction in which the project is to be constructed.

7.1.1.2.5 Required Statements All construction plans shall include the following statements:

- 1) “The proposed floatation tank facility and all equipment shall be constructed and installed in conformity with the approved plans and specifications or approved amendments;” and
- 2) “No substantial alteration, changes, additions, or equipment not specified in the approved plans or allowed in the CODE can be made or added until the plans for such substantial alteration, changes, additions, or equipment are submitted to and approved by the AHJ.”

7.1.1.3 Content of Design Report

7.1.1.3.1 Names / Addresses FLOATATION TANK facility plans shall include the name, address, and contact information for the owner, designer, and builder if available at the time of submission.

7.1.1.4 Plans and Specifications

7.1.1.4.1 Drawings Detailed scaled and dimensional drawings for each individual FLOATATION TANK shall include an area plan and layout plan along with dimensioned longitudinal and transverse cross sections of the FLOATATION TANK.

7.1.1.4.2 Operating Conditions The design documents shall include a record of operating conditions (FLOATATION TANK SOLUTION temperature(s), space temperature, space relative humidity, space dew point) accepted by both the design engineer and owner/operator.

7.1.1.4.3 Floatation Tank Attributes Detailed scaled and dimensional drawings for each individual FLOATATION TANK shall include location and type of:

- 1) Inlets;
- 2) Overflows;
- 3) Drains;
- 4) Suction outlets;
- 5) Overflow gutters or devices;
- 6) Piping;
- 7) Designed water elevation;
- 8) Features, such as ladders and stairs;
- 9) Lighting;
- 10) Markings; and
- 11) Surface materials.

7.1.1.4.4 *Area Design* Detailed scaled and dimensional drawings of the FLOATATION TANK facility and for each individual FLOATATION TANK, as appropriate, shall include location and type of:

- 1) Design of floors and walls enclosing the FLOATATION TANK,
- 2) Floor drains,
- 3) SLIP-RESISTANT flooring,
- 4) FLOATATION TANK room area finishes,
- 5) Drinking fountains or other sources of drinking water,
- 6) Entries and exits,
- 7) Hose bibs, and
- 8) Area lighting.

7.1.1.4.5 *Floatation Tank Recirculation and Treatment Design* Detailed scaled and dimensional drawings for each individual FLOATATION TANK shall contain a flow diagram showing the location, plan, elevation, and schematics of:

- 1) Filters;
- 2) Pumps;
- 3) Disinfection systems;
- 4) SUPPLEMENTAL TREATMENT systems, if installed;
- 5) Ventilation devices or AIR HANDLING SYSTEMS;
- 6) Heaters;
- 7) BACKFLOW prevention assemblies and air gaps;
- 8) Valves;
- 9) Piping;
- 10) Flow meters;
- 11) Gauges;
- 12) Thermometers;

13) Test cocks;

14) Sight glasses; and

15) Drainage system for the disposal of FLOATATION TANK water and filter wastewater.

7.1.1.4.6 **Equipment Room Design** Detailed scaled and dimensional drawings for each individual FLOATATION TANK shall contain a schematic layout of the FLOATATION TANK EQUIPMENT ROOM (or EQUIPMENT ROOM OR AREA if permitted by the AHJ) showing accessibility for installation and maintenance.

7.1.1.4.7 **Chemical Storage Space Design** Detailed scaled and dimensional drawings for each individual FLOATATION TANK shall contain a schematic layout of the FLOATATION TANK facility CHEMICAL STORAGE SPACE(S).

7.1.1.4.8 **Hygiene Facility Design** Detailed scaled and dimensional drawings for each FLOATATION TANK facility shall show the location and number of all available HYGIENE FACILITIES provided including dressing rooms, lockers, SHOWERS, lavatory, and toilet FIXTURES.

7.1.1.4.9 **Plan Approval**

7.1.1.4.9.1 **New Construction**

7.1.1.4.9.1.1 **Approval Limitations** The AHJ shall clearly state on the plans the limitations of their approval.

7.1.1.4.9.1.2 **Other Approvals** The approval shall also state that it is independent of all other required approvals such as Building, Zoning, Fire, Electrical, Structural, and any other approvals as required by local, state, territorial, federal, and tribal laws and the applicant must separately obtain all other required approvals and permits.

7.1.1.4.9.1.3 **Plan Review Coordination** The AHJ shall coordinate their FLOATATION TANK plan review and communicate their approval with other agencies involved in the FLOATATION TANK facility construction.

7.1.1.4.9.1.4 **Plan Review Report** The AHJ shall provide a plan submission compliance review list to the FLOATATION TANK facility owner with the following information:

- 1) Categorical items marked satisfactory, unsatisfactory, not applicable, or insufficient information;
- 2) A comment section keyed to the compliance review list shall detail unsatisfactory and insufficient;
- 3) Indication of the AHJ approval or disapproval of the AQUATIC FACILITY construction plans;
- 4) In the case of a disapproval, specific reasons for disapproval and procedure for resubmittal; and
- 5) Reviewer's name, signature, and date of review.

7.1.1.4.9.1.5 **Plans Maintained** The FLOATATION TANK facility owner shall maintain at least one set of their own approved plans made available to AHJ onsite for as long as the FLOATATION TANK facility is in operation.

7.1.1.4.9.2 **Non-Substantial Alterations**

7.1.1.4.9.2.1 **Alteration Review** The FLOATATION TANK facility owner planning a NON-SUBSTANTIAL ALTERATION shall contact the AHJ to review proposed changes prior to starting the NON-SUBSTANTIAL ALTERATION.

7.1.1.4.9.2.2 **Alteration Scope** The FLOATATION TANK facility operator shall consult with the AHJ to determine if new or modified plans must be submitted for plan review and approval for other NON-SUBSTANTIAL ALTERATIONS proposed.

7.1.1.4.9.3 **Replacements**

7.1.1.4.9.3.1 **Replacement Approval** Prior to replacing equipment, the FLOATATION

TANK facility owner shall submit technical verification to the AHJ that all replacement equipment is equal to that which was originally approved and installed.

7.1.1.4.9.3.2 Replacement Equipment Equivalency The replacement of pumps, filters, feeders, controllers, SKIMMERS, flow-meters, valves, or other similar equipment with identical or substantially similar equipment may be done without submission to the AHJ for approval of new or altered AQUATIC FACILITY plans.

7.1.1.4.9.3.3 Emergency Replacement In emergencies, the replacement may be made prior to receiving the AHJ's approval, with the owner accepting responsibility for proper immediate replacement if the equipment is not deemed equivalent by the AHJ.

7.1.1.4.9.3.3.1 Documentation Where emergency replacements are installed as per MAHC 7.1.1.4.11.3, the owner shall submit documentation for review and approval of the replacement to the AHJ within 45 days.

7.1.1.4.9.3.4 Replacement Record Maintenance The AHJ shall provide the FLOATATION TANK facility owner written approval or disapproval of the proposed replacement equipment's equivalency.

7.1.1.4.9.3.5 Documentation Documentation of proposed, approved, and disapproved replacements shall be maintained in the AHJ's FLOATATION TANK facility files.

7.1.1.4.9.4 Compliance Certificate

7.1.1.4.9.4.1 Construction Compliance Certificate A certificate of construction compliance shall be submitted to the AHJ for all FLOATATION TANK facility plans for new construction and SUBSTANTIAL ALTERATIONS requiring AHJ approvals.

7.1.1.4.9.4.2 Certificate Preparation This certificate shall be prepared by a licensed professional and be within the scope of their practice as defined by the local, state, territorial, federal, and tribal laws governing professional practice within the jurisdiction of the permit issuing official.

7.1.1.4.9.4.3 Certificate Statement The certificate shall also include a statement that the FLOATATION TANK facility, all equipment, and appurtenances have been constructed and/or installed in accordance with approved plans and specifications.

7.1.1.4.9.4.4 Systems Commissioning If commissioning or testing reports for systems such as FLOATATION TANK facility lighting, air handling, recirculation, filtration, and/or DISINFECTION are conducted, then those reports shall be included in furnished documentation.

7.1.1.4.9.4.5 Maintenance Documentation of FLOATATION TANK facility new construction or SUBSTANTIAL ALTERATION plan compliance shall be maintained in the AHJ's FLOATATION TANK facility files.

7.1.1.4.9.5 Construction Permits

7.1.1.4.9.5.1 Building Permit for Construction Construction permits required in this CODE and all other applicable permits shall be obtained before any FLOATATION TANK facility may be constructed.

7.1.1.4.9.5.2 Remodeling Building Permit A construction permit or other applicable permits may be required from the AHJ before SUBSTANTIAL ALTERATION of a FLOATATION TANK facility.

7.1.1.4.9.5.3 Permit Issuance The AHJ shall issue a permit to the owner to operate the FLOATATION TANK facility:

- 1) After receiving a certificate of completion from the DESIGN PROFESSIONAL verifying information submitted, and
- 2) When new construction, SUBSTANTIAL ALTERATIONS, or annual renewal requirements of this CODE have been met.

7.1.1.4.9.5.4 Permit Denial The permit (license) to operate may be withheld, revoked, or denied by the AHJ for noncompliance of the FLOATATION TANK facility with the requirements of this CODE,

and the owner will be provided:

- 1) Specific reasons for disapproval and procedure for resubmittal;
- 2) Notice of the rights to appeal this denial and procedures for requesting an appeal; and
- 3) Reviewer's name, signature and date of review and denial.

7.1.1.4.9.5.5 Documentation Documentation of FLOATATION TANK facility permit renewal or denial shall be maintained in the AHJ's FLOATATION TANK facility files.

7.1.2 Materials

7.1.2.1 Construction Material FLOATATION TANKS shall be constructed of impervious and structurally sound material(s).

7.1.2.1.1 Smooth and Easily Cleaned Construction materials shall provide a smooth, easily cleaned, watertight structure.

7.1.2.1.2 Withstand Anticipated Loads The structure shall be capable of withstanding the anticipated stresses/loads for full and empty conditions.

7.1.2.1.3 Hydrostatic Conditions The structural design shall take into consideration hydrostatic conditions and the integration of the FLOTATION TANK with other structural conditions as required by applicable CODES.

7.1.2.2 Durability All materials shall be inert, non-toxic, resistant to corrosion, impervious, enduring, and resistant to damages related to environmental conditions of the installation region.

7.1.2.3 Watertight FLOATATION TANK shall be designed in such a way to maintain their ability to retain the designed amount of water.

7.1.2.4 Smooth Finish All walls shall have a durable finish suitable for regular scrubbing and cleaning at the waterline.

7.1.3 Equipment Standards

7.1.3.1 General

7.1.3.1.1 Accredited Standards Where applicable, all equipment used or proposed for use in floatation tank facilities governed under this CODE shall be:

- 1) Of a proven design and construction, and
- 2) CERTIFIED, LISTED, AND LABELED to a specific STANDARD for the specified equipment use by an ANSI-accredited certification organization.

7.1.3.1.2 No Standards Where STANDARDS do not exist, technical documentation shall be submitted to the AHJ to demonstrate acceptability for use in AQUATIC FACILITIES.

7.1.3.1.2.1 Proof of Acceptability The AHJ shall have the authority to require tests, as proof of acceptability.

7.1.4^A Floatation Tank Electrical Systems and Components

7.1.4.1 General Guidance

7.1.4.1.1 NEC Requirements Electrical wiring and systems shall comply with the requirements of the NEC.

7.1.4.1.1.1 Providing Relief Nothing in this CODE shall be construed as providing relief from any applicable requirements of the NEC or other applicable CODE.

7.1.4.1.2 Indoor Aquatic Facilities A FLOATATION TANK and room containing a FLOATATION TANK shall be considered a wet and corrosive environment.

7.1.5 Food and Drink Concessions

7.1.5.1 Meet AHJ Requirements Concessions for food and drink in a FLOATATION TANK facility shall meet all AHJ requirements.

7.1.6 Water Supply/Wastewater Disposal

7.1.6.1 Water Supply Water serving a FLOATATION TANK facility shall be supplied from a potable water source.

7.1.6.2 Sanitary Wastes

7.1.6.2.1 Discharged Wastewater from all PLUMBING FIXTURES in the entire FLOATATION TANK facility shall be discharged to a municipal sanitary sewer system, if available.

7.1.6.2.2 Onsite Sewer System If a municipal sanitary sewer system is not available, all wastewater shall be disposed to an onsite sewer system that is properly designed to receive the entire wastewater capacity.

7.1.6.3 Floatation Tank Wastewater Wastewater/FLOATATION TANK SOLUTION from a FLOATATION TANK, including filter backwash water, shall be discharged to a sanitary sewer system having sufficient capacity to collect and treat wastewater or to an onsite sewage disposal system designed for this purpose.

7.1.7 Circulation System

7.1.7.1 Hydraulically Balanced The RECIRCULATION SYSTEM shall be hydraulically balanced to ensure effective distribution of treated water.

7.1.7.2 Filter Sizing Filtration system components shall be designed and sized to meet the applicable volumetric TURNOVER requirements specified in MAHC 7.2.9.

7.1.7.3 Pump Sizing Pump(s) shall be designed and sized to meet the applicable volumetric TURNOVER requirements specified in MAHC 7.2.9.

7.1.7.4 Submerged Suction Fittings or Suction Outlets Submerged suction fittings or suction outlets shall be CERTIFIED, LISTED, AND LABELED to ANSI/APSP-16 2017 by an ANSI-accredited organization.

7.1.8^A Disinfection

7.1.8.1 Disinfection Types DISINFECTION shall be provided by either:

- 1) Ozone treatment system; or
- 2) UV treatment system.

7.1.8.2 Ozone and UV Disinfection Systems Ozone and UV DISINFECTION systems when used as the primary DISINFECTION system, shall meet the 3-log reduction of influent bacteria DISINFECTION efficacy as tested in accordance with the criteria specified in Annex H.1 of NSF/ANSI 50-2017 at the design filtration flow rate.

7.1.8.3 Ozone Disinfection When an Ozone DISINFECTION system is used, the criteria for ozone level and ozone production testing specified in Annex H.2 and H.3 respectively, of NSF/ANSI 50-2017 must be met.

7.1.8.3.1 Ozone Levels Ozone levels in the FLOATATION TANK SOLUTION shall not exceed 0.1 ppm (*e*).

7.1.8.4 UV Disinfection When a UV DISINFECTION system is used as the primary DISINFECTION system, the following must be provided:

- 1) Calibrated UV sensors shall be installed per MAHC 4.7.3.3.3.5; and

- 2) If the UV equipment fails to produce the required dosage as measured by the automated sensor, an alarm or other indication shall be initiated to alert staff.

7.1.9^A Ventilation

7.1.9.1 Room Air Handling System AIR HANDLING SYSTEM(S) shall be provided when necessary for the room containing FLOATATION TANK(S) and shall be designed, constructed, and installed to support the health and SAFETY of the FLOATATION TANK facility PATRONS.

7.1.9.2 Tank Air Quality Ventilation serving the FLOATATION TANK shall be provided when necessary to ensure acceptable air quality for human health within the FLOATATION TANK.

7.1.10 Floors

7.1.10.1 Floors Floors in room containing FLOATATION TANK(S) shall have a smooth, easy-to-clean, impervious-to-water, SLIP-RESISTANT surface.

7.1.10.1.1 Floor Drains Floor drains shall be installed in rooms containing FLOATATION TANKS and dressing areas where PLUMBING FIXTURES are located.

7.1.10.1.1.1 Opening Grill Covers Floor drain opening grill covers shall be ½-inch (1.3 cm) or less in width or diameter.

7.1.10.1.1.2 Sloped to Drain Floors shall be sloped to drain water or other liquids.

7.1.11 Cleansing Showers CLEANSING SHOWERS shall be provided in or immediately available/accessible to the room containing the FLOATATION TANK(S).

7.2 Floatation Tank Operation

7.2.1 Operating Permits

7.2.1.1 Owner Responsibilities

7.2.1.1.1 Permit to Operate Required Prior to opening to the public, the FLOATATION TANK facility owner shall apply to the AHJ for a permit to operate.

7.2.1.1.2 Separate A permit is required for newly constructed or substantially altered FLOATATION TANK at an existing FLOATATION TANK facility.

7.2.1.1.3 Prior to Issuance Before a permit to operate is issued, the following procedures shall be completed:

- 1) The FLOATATION TANK facility owner has demonstrated the FLOATATION TANK facility, including all newly constructed or substantially altered FLOATATION TANKS, is in compliance with the requirements of this CODE, and
- 2) The AHJ has approved the FLOATATION TANK facility to be open to the public.

7.2.1.1.4 Permit Details The permit to operate shall:

- 1) Be issued in the name of the owner,
- 2) List all FLOATATION TANKS included under the permit, and
- 3) Specify the period of time approved by the AHJ.

7.2.1.1.5 Permit Expiration Permits to operate shall terminate according to the AHJ schedule.

7.2.1.1.6 Permit Renewal The FLOATATION TANK facility owner shall renew the permit to operate prior to the scheduled expiration of an existing permit to operate a FLOATATION TANK facility.

7.2.1.1.7 Permit Denial The permit to operate may be withheld, revoked, or denied by the AHJ for noncompliance of the FLOATATION TANK facility with the requirements of this CODE.

7.2.1.1.8 **Owner Responsibilities** The owner of a FLOATATION TANK facility is responsible for the facility being operated, maintained, and managed in accordance with the requirements of this CODE.

7.2.1.2 **Operating Permits**

7.2.1.2.1 **Permit Location** The permit to operate shall be posted at the FLOATATION TANK facility in a location conspicuous to the public.

7.2.1.2.2 **Operating Without a Permit** Operation of a FLOATATION TANK facility or newly constructed or substantially altered FLOATATION TANK without a permit to operate shall be prohibited.

7.2.1.2.3 **Required Closure** The AHJ may order a newly constructed or substantially altered FLOATATION TANK without a permit to operate to close until the FLOATATION TANK facility has obtained a permit to operate.

7.2.2 **Inspections**

7.2.2.1 **Preoperational Inspections**

7.2.2.1.1 **Terms of Operation** The FLOATATION TANK facility may not be placed in operation until an inspection approved by the AHJ shows compliance with the requirements of this CODE or the AHJ approves opening for operation.

7.2.2.2 **Exemptions**

7.2.2.2.1 **Applying for Exemption** A FLOATATION TANK facility seeking an initial exemption or an existing FLOATATION TANK facility claiming to be exempt according to applicable regulations shall contact the AHJ for application details/forms.

7.2.2.2.2 **Change in Exemption Status** A FLOATATION TANK facility that sought and received an exemption from a public regulation shall contact the AHJ if the conditions upon which the exemption was granted change so as to eliminate the exemption status.

7.2.2.3 **Variances**

7.2.2.3.1 **Variance Authority** The AHJ may grant a variance to the requirements of this CODE.

7.2.2.3.2 **Applying for a Variance** A FLOATATION TANK facility seeking a variance shall apply in writing with the appropriate forms to the AHJ.

7.2.2.3.2.1 **Application Components** The application shall include, but not be limited to:

- 1) A citation of the CODE section to which the variance is requested;
- 2) A statement as to why the applicant is unable to comply with the CODE section to which the variance is requested;
- 3) The nature and duration of the variance requested;
- 4) A statement of how the intent of the CODE will be met and the reasons why the public health or SAFETY would not be jeopardized if the variance was granted; and
- 5) A full description of any policies, procedures, or equipment that the applicant proposes to use to rectify any potential increase in health or SAFETY risks created by granting the variance.

7.2.2.3.3 **Revoked** Each variance shall be revoked when the permit attached to it is revoked.

7.2.2.3.4 **Not Transferable** A variance shall not be transferable unless otherwise provided in writing at the time the variance is granted.

7.2.3 Operation and Maintenance

7.2.3.1 Preventive Maintenance Plan

7.2.3.1.1 *Written Plan*

7.2.3.1.1.1 Preventive Maintenance Plan Available A written comprehensive preventive maintenance plan for each FLOATATION TANK shall be available at the FLOATATION TANK facility.

7.2.3.1.1.2 Contents The FLOATATION TANK facility preventive maintenance plan shall include details and frequency of owner/operator's planned routine facility inspection, maintenance, and replacement of recirculation and water treatment components.

7.2.3.1.2 *Facility Documentation*

7.2.3.1.2.1 Original Plans and Specifications Available A copy of the approved plans and specifications for each AQUATIC VENUE constructed after the adoption of this CODE shall be available at the FLOATATION TANK facility.

7.2.3.1.2.2 Equipment Inventory A comprehensive inventory of all mechanical equipment associated with each FLOATATION TANK shall be available at the AQUATIC FACILITY.

7.2.3.1.2.3 Inventory Details This inventory shall include:

- 1) Equipment name and model number;
- 2) Manufacturer and contact information;
- 3) Local vendor/supplier and technical representative, if applicable; and
- 4) Replacement or service dates and details.

7.2.3.1.2.4 Equipment Manuals Operation manuals for all mechanical equipment associated with each FLOATATION TANK shall be available at the FLOATATION TANK facility.

7.2.3.1.3.4.1 No Manual If no manufacturer's operation manual is available, then the FLOATATION TANK facility should create a written document that outlines STANDARD operating procedures for maintaining and operating the piece of equipment.

7.2.4 Ventilation

7.2.4.1 Purpose AIR HANDLING SYSTEMS shall be maintained and operated by the owner/operator to protect the health and SAFETY of the facility's PATRONS.

7.2.4.2 Original Characteristics AIR HANDLING SYSTEMS shall be maintained and operated to comply with all requirements of the original system design, construction, and installation.

7.2.5 Electrical Systems and Components

7.2.5.1 Electrical Repairs

7.2.5.1.1 Code Compliance Repairs or alterations to electrical equipment and associated equipment shall preserve compliance with the NEC and all applicable local, state, territorial, federal, and tribal laws. If there is a more than one applicable requirement then the most restrictive would apply.

7.2.5.1.2 Immediately Repaired All defects in the electrical system shall be immediately repaired.

7.2.5.1.3 Wiring Electrical wiring, whether permanent or temporary, shall comply with the NEC and all applicable local, state, territorial, federal, and tribal laws.

7.2.5.2 Electrical Receptacles

7.2.5.2.1 *New Receptacles* The installation of new electrical receptacles shall be subject to electrical-construction requirements of this CODE and all applicable local, state, territorial, federal, and tribal laws.

7.2.5.2.2 *Repairs* Repairs or maintenance to existing receptacles shall maintain compliance with the NEC and with 29 CFR 1910.304(b) (3) (ii).

7.2.5.2.3 *Replacement* Replacement receptacles shall be of the same type as the previous ones (*e.g., grounding-type receptacles shall be replaced only by grounding-type receptacles*), with all grounding conductors connected and proper wiring polarity preserved.

7.2.5.2.4 *Substitutions* Where the original-type of receptacle is no longer available, a replacement and installation shall be in accordance with all applicable local, state, territorial, federal, and tribal laws.

7.2.5.3 Ground-Fault Circuit Interrupter

7.2.5.3.1 *Manufacturer's Recommendations* Where receptacles are required to be protected by GFCI devices, the GFCI devices shall be tested following the manufacturer's recommendations.

7.2.5.3.2 *Testing* Required GFCI devices shall be tested as part of scheduled maintenance on the first day of operation, and monthly thereafter, until the BODY OF WATER is drained and the equipment is prepared for STORAGE.

7.2.5.4 Grounding

7.2.5.4.1 *Maintenance and Repair* Maintenance or repair of electrical circuits or devices shall preserve grounding compliance with the NEC and all applicable local, state, territorial, federal, and tribal laws.

7.2.5.4.2 *Grounding Conductors* Grounding conductors that have been disconnected shall be re-inspected as required by the local building CODE authority prior to AQUATIC VENUE being used by BATHERS.

7.2.5.4.3 *Damaged Conductors* Damaged grounding conductors and grounding electrodes shall be repaired immediately.

7.2.5.4.4 *Damaged Conductor Repair* Damaged grounding conductors or grounding electrodes associated with recirculation or DISINFECTION equipment or with underwater lighting systems shall be repaired by a qualified person who has the proper and/or necessary skills, training, or credentials to carry out this task.

7.2.5.4.5 *Public Access* The public shall not have access to the FLOATATION TANK until such grounding conductors or grounding electrodes are repaired.

7.2.5.4.6 *Venue Closure* The FLOATATION TANK with damaged grounding conductors or grounding electrodes, that are associated with recirculation or DISINFECTION equipment or with underwater lighting systems, shall be closed until repairs are completed and inspected by the AHJ.

7.2.5.5 Bonding

7.2.5.5.1 *Code Compliance* Maintenance or repair of all metallic equipment, electrical circuits or devices, or reinforced concrete structures shall preserve bonding compliance with the NEC and with all applicable local, state, territorial, federal, and tribal laws.

7.2.5.5.2 *Bonding Conductors* Bonding conductors shall not be disconnected except where they will be immediately reconnected.

7.2.5.5.3 *Disconnected Conductors* The FLOATATION TANK shall not be used by BATHERS while

bonding conductors are disconnected.

7.2.5.5.4 **Removable Covers** Removable covers protecting bonding conductors (*e.g., at ladders*), shall be kept in place except during bonding conductor inspections, repair, or replacement.

7.2.5.5.5 **Scheduled Maintenance** Bonding conductors, where accessible, shall be inspected semi-annually as part of scheduled maintenance.

7.2.5.5.6 **Corrosion** Bonding conductors and any associated clamps shall not be extensively corroded.

7.2.5.5.7 **Continuity** Continuity of the bonding system associated with RECIRCULATION SYSTEM or DISINFECTION equipment or with underwater lighting systems shall be inspected by the AHJ following installation and any major construction around the AQUATIC FACILITY.

7.2.5.6 **Extension Cords**

7.2.5.6.1 **Temporary Cords and Connectors** Temporary extension cords and power connectors shall not be used as a substitute for permanent wiring.

7.2.5.6.2 **Minimum Distance from Water** All parts of an extension cord shall be restrained at a minimum of 6 feet (*1.8 m*) away when measured along the shortest possible path from a BODY OF WATER during times when the FLOATATION TANK facility is open.

7.2.5.6.3 **Exception** An extension cord may be used within 6 feet (*1.8 m*) of the nearest edge of a BODY OF WATER if a permanent wall exists between the BODY OF WATER and the extension cord.

7.2.5.6.4 **GFCI Protection** The circuit supplying an extension cord shall be protected by a GFCI device when the extension cord is to be used within 6 feet (*1.8 m*) of a BODY OF WATER.

7.2.5.6.5 **Code Compliance** An extension cord incorporating a GFCI device may be used if that is acceptable under all applicable local, state, territorial, federal, and tribal laws.

7.2.5.6.6 **Compliance** The use of extension cords shall comply with 29 CFR 1910.304.

7.2.5.7 **Portable Electric Devices** Portable line-powered electrical devices, such as radios or drills, shall not be used within 6 feet (*1.8 m*) horizontally of the nearest inner edge of a BODY OF WATER, unless connected to a GFCI-protected circuit.

7.2.5.8 **Communication Devices and Dispatch Systems** The maintenance and repair of communication devices and dispatch systems shall preserve compliance with the NEC.

7.2.6 **Plumbing**

7.2.6.1 **Water Supply**

7.2.6.1.1 **Water Pressure** All plumbing shall be maintained in good repair with no leaks or discharge.

7.2.6.1.2 **Cross-Connection Control** Water introduced into the FLOATATION TANK, either directly or to the RECIRCULATION SYSTEM, shall be supplied through an air gap or by another method which will prevent BACKFLOW and back-siphonage.

7.2.6.2 **Wastewater**

7.2.6.2.1 **Wastewater Disposal** FLOATATION TANK wastewater/FLOATATION TANK SOLUTION, including backwash water and cartridge cleaning water, shall be disposed of in accordance with all applicable local, state, territorial, federal, and tribal laws.

7.2.6.2.2 **Drainage** Wastewater and backwash water shall not be returned to a FLOATATION TANK or the FLOATATION TANK facility's water treatment system.

7.2.6.2.3 *Drain Line* Filter backwash lines, DECK drains, and other drain lines connected to the FLOATATION TANK facility or the FLOATATION TANK facility RECIRCULATION SYSTEM shall be discharged through an approved air gap.

7.2.6.2.4 *No Standing Water/Solution* Discharge water/FLOATATION TANK SOLUTION shall not create any standing water/solution, a nuisance, offensive odors, stagnant wet areas, or an environment for the breeding of insects.

7.2.7 Solid Waste Management

7.2.7.1 Storage Receptacles

7.2.7.1.1 *Good Repair and Clean* Outside waste and recycling containers shall be maintained in good repair and clean condition.

7.2.7.1.2 *Storage Areas* Outside waste and recycling STORAGE areas shall be maintained in good repair and clean condition.

7.2.7.2 Disposal

7.2.8.2.1 *Frequency* Solid waste and recycled materials shall be removed at a frequency to prevent attracting vectors or causing odor.

7.2.8.2.2 *Code Compliance* Solid waste and recycled materials shall be disposed of in compliance with all applicable local, state, territorial, federal, and tribal laws.

7.2.8^A Treatment System Required Operation Time

7.2.8.1 *Turnover at Opening and Closing* FLOATATION TANK filtration and DISINFECTION systems shall be operated for one volumetric TURNOVER before first use during the day and four volumetric TURNOVERS after the last PATRON at the end of the day; and

7.2.8.1.1 *Turnovers Between Users* For systems disinfected with Ozone or UV systems, a minimum of three volumetric TURNOVERS between users; or

7.2.8.2 *Treatment* Where FLOATATION TANK systems with external holding reservoirs are used to hold the FLOATATION TANK SOLUTION between PATRON use, all of the FLOATATION TANK SOLUTION must pass through the filtration and DISINFECTION systems before being returned to the FLOATATION TANK.

7.2.8.3 *Controller* The FLOATATION TANK system controller shall have the minimum length of filtration/DISINFECTION time to achieve three volumetric TURNOVERS built into the controller as a default.

7.2.8.3.1 *Turnovers* If the FLOATATION TANK controller does not have the capability of setting a default filtration time, the minimum filtration/DISINFECTION time required to achieve three volumetric TURNOVERS shall be posted adjacent to the controller.

7.2.9 Disinfection

7.2.9.1 *3-log Inactivation* Ozone and UV systems shall be operated and maintained to achieve the required design performance for a 3-log inactivation as specified in MAHC 7.1.8.2.

7.2.9.2 *Operation* Ozone and UV systems shall be operated and maintained in accordance with manufacturer's instructions.

7.2.9.3 *Ozone Concentration* Ozone DISINFECTION systems shall be operated and maintained so as to meet the ozone concentration output and not exceed the limits of off-gassed ozone in accordance with MAHC 7.1.8.3.

7.2.9.4 UV calibrated sensors

1) When UV is used, the UV sensors shall be calibrated at a frequency in accordance with manufacturer recommendations.

2) Records of calibration shall be maintained by the facility and available for review by the AHJ.

7.2.10 USP Grade Magnesium Sulfate Only USP grade magnesium sulfate shall be used in the FLOATATION TANK SOLUTION.

7.2.11 Cleansing Showers and Hygiene Facilities

7.2.11.1 Signage Signs or other comparable means of notification shall be provided instructing PATRONS to SHOWER before entering the FLOATATION TANK.

7.2.11.2 Cleaned and Sanitized HYGIENE FACILITY FIXTURES, CLEANSING SHOWERS, dressing area FIXTURES, and furniture shall be cleaned and SANITIZED daily, and more often if necessary, with an EPA-REGISTERED product, and more often if necessary, to provide a clean and sanitary environment.

7.2.11.3 Mold and Mildew HYGIENE FACILITY floors, walls, and ceilings shall be kept clean and free of visible mold and mildew.

7.2.11.4 Hand Wash Station HANDWASHING STATIONS shall include the following items:

- 1) Hand wash sink,
- 2) Adjacent soap with dispenser,
- 3) Hand drying device or paper towels and dispenser, and
- 4) Trash receptacle.

7.2.12^A Cleaning

7.2.12.1 Daily Cleaning FLOATATION TANK interior surfaces at the waterline shall be scrubbed or wiped down on a daily basis to prevent build-up of slime and biofilm layers.

7.2.12.2 Weekly Cleaning FLOATATION TANK interior surfaces shall be scrubbed or wiped down on a weekly basis to prevent build-up of slime and biofilm layers.

7.2.12.3 Draining FLOATATION TANKS shall be drained and all interior surfaces shall be scrubbed or wiped down prior to refilling at a frequency necessary to prevent build-up of slime and biofilm layers.

7.2.13^A Fecal/Vomit/Blood Contamination Response

7.2.13.1 Contamination Response Plan All AQUATIC FACILITIES with FLOATATION TANKS shall have a CONTAMINATION RESPONSE PLAN as specified in MAHC 6.5.1.

7.2.13.2 Floatation Tank Solution Contamination Response

7.2.13.2.1 Closure In the event of fecal or vomit contamination in a FLOATATION TANK, the AQUATIC FACILITY QUALIFIED OPERATOR shall immediately close the FLOATATION TANK to users until remediation procedures are complete.

7.2.13.2.2 Physical Removal Contaminating material shall be removed in accordance with MAHC 6.5.2.2.

7.2.13.3 Floatation Tank Solution Contamination Disinfection

7.2.13.3.1 Formed-Stool Contamination The filtration and DISINFECTION systems for formed-stool contaminated FLOATATION TANK SOLUTION shall be operated for the minimum volumetric TURNOVERS specified in MAHC 7.2.9.

7.2.13.3.2 Diarrheal-Stool Contamination Diarrheal-stool contaminated float water shall be completely drained and the contaminated FLOATATION TANK surfaces disinfected prior to refilling.

7.2.13.3.3 Vomit-Contamination Vomit-contaminated FLOATATION TANK SOLUTION shall be completely drained and the contaminated FLOATATION TANK surfaces disinfected prior to refilling.

7.2.13.3.4 **Blood-Contamination** The filtration and DISINFECTION systems for blood-contaminated FLOATATION TANK SOLUTION shall be operated for the minimum volumetric TURNOVERS specified in MAHC 7.2.9.

7.2.14 **Operations**

7.2.14.1 **Operations Manual**

7.2.14.1.1 **Develop** Each FLOATATION TANK facility shall develop an operations manual to keep at the FLOATATION TANK facility in both printed and electronic formats.

7.2.14.1.2 **Include** The manual shall at minimum include, but not be limited to the following items:

- 1) FLOATATION TANK description(s) and locations,
- 2) Facility communication,
- 3) List of chemicals and system information,
- 4) Fecal/vomit/blood CONTAMINATION RESPONSE PLANS,
- 5) Preventive maintenance plan, and
- 6) Any other STANDARD operation and maintenance policies and instructions or applicable information for each FLOATATION TANK at the facility.

7.2.14.2 **Operation Records** FLOATATION TANK facilities shall keep records pertaining to the operation, maintenance, and management of the FLOATATION TANK facility on a minimum schedule as prescribed under MAHC 7.2.15.3.

7.2.14.2.1 **Records** FLOATATION TANK facility records shall be:

- 1) Kept for a minimum of 3 years, and
- 2) Available upon request by the AHJ.

7.2.14.2.2 **Additional Documentation** Applicable local, state, territorial, federal, and tribal laws may require additional records, documentation, and forms.

7.2.15.3 **Safety and Maintenance Inspection and Recordkeeping** The QUALIFIED OPERATOR or RESPONSIBLE SUPERVISOR shall ensure that SAFETY and preventive maintenance inspections are done at the FLOATATION TANK facility during seasons or periods when the FLOATATION TANK facility is open and that the results are recorded in a log or form maintained at the FLOATATION TANK facility.

7.2.14.3.1 **Daily Inspection Items** The QUALIFIED OPERATOR or RESPONSIBLE SUPERVISOR shall ensure that a daily FLOATATION TANK facility preventive maintenance inspection is done before opening and that it shall include:

- 1) Drain covers, vacuum fitting covers, SKIMMER equalizer covers, and any other suction outlet covers are in place, secure, and unbroken;
- 2) SKIMMER baskets, weirs, lids, flow adjusters, and suction outlets are free of any blockage;
- 3) INLET and return covers and any other fittings are in place, secure, and unbroken;
- 4) Safety warning signs and other signage are in place and in good repair;
- 5) Entrapment prevention systems are operational;
- 6) Recirculation, DISINFECTION systems, controller(s), and probes are operating as required;
- 7) Underwater lights and other lighting are intact with no exposed wires or water in lights;
- 8) Slime and biofilm have been removed from accessible surfaces of FLOATATION TANKS;
- 9) Doors to nonpublic areas (CHEMICAL STORAGE SPACES, offices, etc.) are locked;

- 10) Fecal/vomit/blood incident CONTAMINATION RESPONSE PLANS, materials, and equipment are available;
- 11) Electrical devices are in good working condition and meet the requirements specified in the NEC and MAHC; and
- 12) Assessing FLOATATION TANK SOLUTION clarity such that the bottom and objects in the FLOATATION TANK are clearly visible.

7.2.14.3.2 Other Inspection Items The QUALIFIED OPERATOR or RESPONSIBLE SUPERVISOR shall ensure that the FLOATATION TANK facility preventive maintenance inspections shall also include:

- 1) Monthly tests of GFCI devices and
- 2) Inspections every 6 months of bonding conductors, where accessible.

7.2.14.4 Illness and Injury Incident Reports

7.2.14.4.1 Incidents to Record The owner/operator shall ensure that a record is made of all injuries and illness incidents at the FLOATATION TANK facility which:

- 1) Results in deaths;
- 2) Requires resuscitation, CPR, oxygen, or AED use;
- 3) Requires transportation of the PATRON to a medical facility; or
- 4) Is a PATRON illness or disease outbreak associated with FLOATATION TANK SOLUTION quality.

7.2.14.4.2 Info to Include Illness and injury incident report information shall include

- 1) Date,
- 2) Time,
- 3) Location,
- 4) Incident including type of illness or injury and cause or mechanism,
- 5) Names and addresses of the individuals involved,
- 6) Actions taken,
- 7) Equipment used, and
- 8) Outcome of the incident.

7.2.14.4.3 Notify the AHJ In addition to making such records, the owner/operator shall ensure that the AHJ is notified within 24 hours of the occurrence of an incident recorded in MAHC 7.2.15.44.

7.2.14.5 Bodily Fluids Remediation Log

7.2.14.5.1 Contamination Incidents A Body Fluid Contamination Response Log shall be maintained to document each occurrence of contamination of the FLOATATION TANK SOLUTION or its immediately adjacent areas by formed or diarrheal fecal material, whole stomach discharge of vomit, and blood.

7.2.14.5.2 Standard Operating Procedures The FLOATATION TANK facility's STANDARD operating procedures for responding to these contamination incidents shall be readily available for review by the AHJ.

7.2.14.5.3 Required Information The log shall include the following information recorded at the time of the incident:

- 1) Person conducting response;
- 2) Qualified operator or onsite responsible supervisor on duty;

- 3) Date and time of incident response;
- 4) Specific area, if not in the FLOATATION TANK SOLUTION, contaminated by incident;
- 5) Type and form of body fluid observed (*for example, diarrheal or formed stool, vomit, or blood*);
- 6) Date and time when the area was closed;
- 7) Remediation procedures used after the incident including contact time, if applicable; and
- 8) Date and time of reopening.

7.2.15 AHJ Inspections

7.2.15.1 Inspection Process

7.2.15.1.1 Inspection Authority The AHJ shall have the right to inspect or investigate the operation and management of a FLOATATION TANK facility.

7.2.15.1.2 Inspection Scope and Right Upon presenting proper identification, an authorized employee or agent of the AHJ shall have the right to and be permitted to enter any FLOATATION TANK facility or FLOATATION TANK area, including the recirculation equipment and piping area, at any reasonable time for the purpose of inspecting the FLOATATION TANK to do any of the following:

- 1) Inspect, investigate, or evaluate for compliance with this CODE;
- 2) Verify compliance with previously written violation orders;
- 3) Collect samples or specimens;
- 4) Examine, review, and copy relevant documents and records;
- 5) Obtain photographic or other evidence needed to enforce this CODE; or
- 6) Question any person.

7.2.15.1.2.1 Reasonable Time An authorized employee or agent of the AHJ shall not enter a room containing a FLOATATION TANK while the room or the tank is occupied by a customer.

7.2.15.1.3 Based on Risk A FLOATATION TANK facility's inspection frequency may be amended based on a risk of FLOATATION TANK SOLUTION injury and illness.

7.2.15.1.4 Inspection Interference It is a violation of this CODE for a person to interfere with, deny, or delay an inspection or investigation conducted by the AHJ.

7.2.15.2 Publication of Inspection Forms

7.2.15.2.1 Inspection Form Publication The AHJ may publish or post on the web or other source the reports of FLOATATION TANK facility inspections.